



Front attachments

Combine harvester front attachments

LEXION TRION AVERO DOMINATOR

CLAAS



Harvest efficiently,
right from the start.



A range as diverse
as your requirements.

The wide range of CLAAS combines offers you the right machine for every job. But the harvesting process starts with the front attachment. Only the right one will allow your machine to work effectively and to perform to the highest standard.

CLAAS has the right front attachment for every situation.

The CLAAS classics.

- CERIO: the standard cutterbar for high-performance grain harvesting
- VARIO: the specialist for grain and rapeseed with an adjustable cutterbar table
- MAXFLEX: the flexible front attachment for loss-free harvesting of crops close to the ground
- CONVIO: the draper cutterbar for all crop types including those that grow close to the ground
- CORIO: the proven pickers for grain maize and corn-cob mix
- Folding cutterbars: the compact solution in smaller-scale settings



VARIO
increases the threshing output of the machine in grain and rapeseed by up to 10%.
Page 16

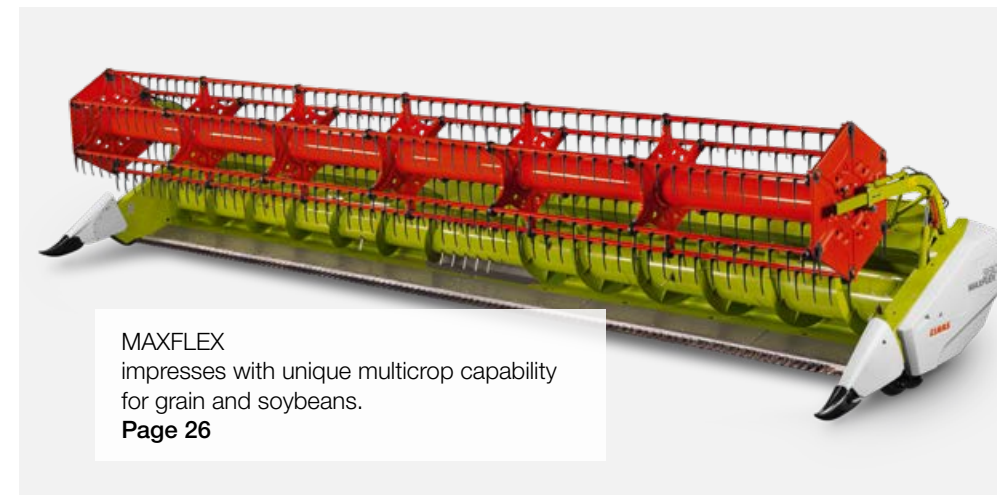

MAXFLEX
impresses with unique multicrop capability for grain and soybeans.
Page 26



Folding cutterbars save you the effort of attaching and detaching.
Page 42



CERIO
delivers high area output in grain crops, even in high-yield regions.
Page 12



CORIO
makes maize picking more efficient.
Page 44



CONVIO
delivers an extremely even crop flow in rapeseed, grain and crops that grow close to the ground.
Page 30

Overview of front attachments	6
Standard cutterbars	8
CERIO cutterbars	12
VARIO cutterbars	16
CERIO and VARIO equipment	22
VARIO and CERIO rice harvesting	24
MAXFLEX cutterbars	26
CONVIO FLEX, CONVIO	30
CONVIO FLEX and CONVIO equipment	38
Folding cutterbars	40
CORIO CONSPEED, CORIO	44
SUNSPEED	52
SWATH UP	56
Feeder housing	60
Front attachment guidance, front attachment detection	62
Equipment	66
Transport trailers	68
Front attachment matrix	
Cutterbars	70
Pickers	72
Advantages	74
Technical data	75

Combine harvester front attachments. As diverse as your requirements.

For every situation.

CLAAS ensures that the harvesting process gets off to the best possible start by offering you the right front attachment – and therefore a high level of flexibility – for every threshable grain. Whether you are harvesting grain crops, such as wheat, rye, barley, oats and triticale or rapeseed, maize, sunflowers, rice, soya, flax, beans, lentils, millet, grass seed or clover seed – CLAAS front attachments allow you to make full use of your combine's performance potential.

The wide range of CLAAS front attachments offers you the perfect answer – for every machine, every application, every crop and every requirement.

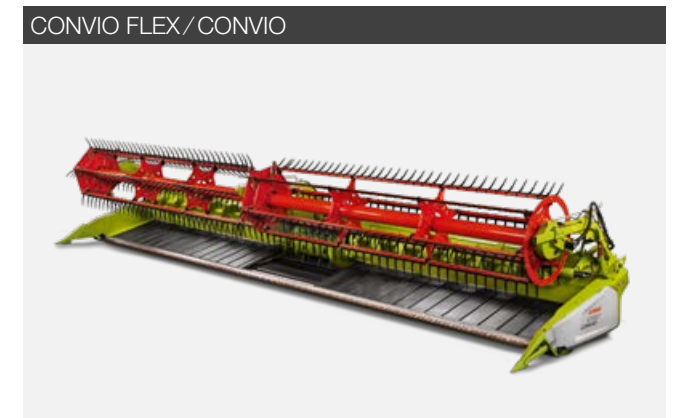

Choose your front attachment.

Regardless of where in the world you are harvesting, CLAAS has the right cutterbar for every threshable crop.



combine-front-attachments.claas.com



Standard cutterbars.

The C 490 to C 370 standard cutterbars are equipped with the tried and trusted rigid cutterbar table. They impress with their excellent manageability and remarkable qualities.

The highlights at a glance:

- Intake auger diameter of 580 mm for excellent crop flow
- C 490, C 430 and C 370 for AVERO
- C 450, C 420 for the DOMINATOR 130
- Robust knife drive
- Proven rigid cutterbar table
- MULTIFINGER intake auger
- Hydraulic reel drive



Field of use.

The compact standard cutterbars from CLAAS deliver excellent grain harvesting results. They represent a reliable cutterbar choice for the DOMINATOR and the AVERO which is ideal for harvesting in small areas and compact field patterns.

Technology.

- Proven rigid cutterbar table
- Robust knife drive via oil-bath transmission
- 1,120 strokes/min
- Automatic tensioning of drive belts
- MULTIFINGER intake auger
- 580 mm diameter intake auger
- Infinitely adjustable intake auger height



Robust drive

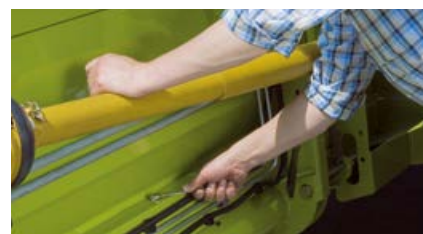

Stripper bars adjustable from outside (C 490, C 430, C 370)



The C 450 and C 420 cutterbars are available for the DOMINATOR 130



The transport trailer enables fast, easy transfers, even between distant fields



CERIO cutterbars.

CLAAS has extended its range of standard cutterbars with the CERIO 930 to 560 models. These are based on the VARIO 930 to 500 cutterbars and represent an optimal alternative for grain harvesting.

The highlights at a glance:

- Large, 660 mm diameter intake auger for optimal crop flow
- Reel optimised to reduce stalk take-up
- MULTIFINGER intake auger
- Crop dividers adjustable for height without tools
- Cutterbar table has an overall manual adjustment range of 200 mm

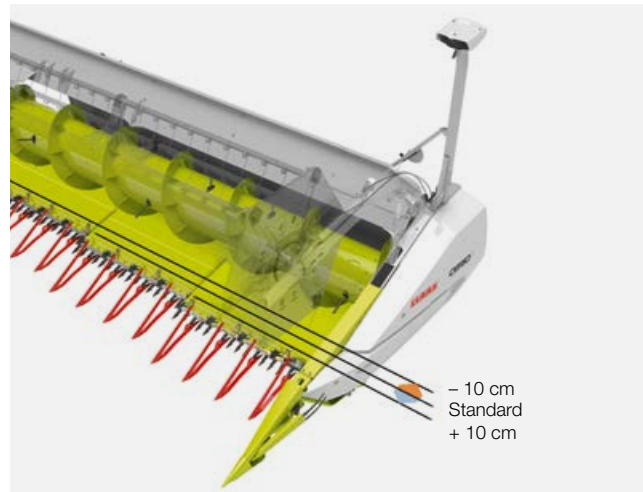

Technology.

- Manually adjustable table position from -100 mm to +100 mm
- Overall manual adjustment range of 200 mm
- Knife drive shaft with automatic telescopic function
- Continuous knife bar and continuous reel
- Front attachment mechanical drive on one side
- Intake auger and knife bar mechanically driven via gearbox and drive shaft
- Reel with optimised reel tine carriers, wear-resistant tine tube bearings and a new design to reduce the risk of wrapping and stalk take-up
- Angled cross-tube for a better view of the cutterbar table from the cab
- Infinitely adjustable intake auger height
- Reversible feeder housing and intake auger
- Stripper bars adjustable from the outside
- LASER PILOT for automatic steering system can be folded and adjusted without tools
- Automatic parking and transport position
- Automatic operating position

Field of use.

The CERIO model series is based on the VARIO 930 to 560 cutterbars and is an alternative for grain harvesting. It is ideally suited to deliver high performance and high area output, whether operating in low or high-yield regions. The cutterbar table can be adjusted manually from -100 mm to +100 mm. This means that the cutterbar is able to respond to differing crop conditions or varieties.

The wide range of models, from the CERIO 930 to the CERIO 560, allows the LEXION, TRION and AVERO to use CERIO cutterbars



Cutterbar adjustment.

- Manual adjustment under cutterbar table
- Ten screw fixings allow adjustment of cutterbar table
- Five table positions can be set: + 100 mm, + 50 mm, 0 mm, - 50 mm, - 100 mm

Use in rice.

The CERIO cutterbars are equipped ex factory – or can easily be converted - with a coated feed roller and a rice harvesting system for optimal performance in rice.



Rugged drive train.

A planetary gear system ensures that the knife bar drive runs extremely smoothly. When the cutterbar table position is changed, the drive shaft adjusts telescopically at the same time, thus allowing work to continue in any position without the need for operator intervention.

The feed roller and knife drive are protected by individual over-load clutches. This system allows the CERIO cutterbar to withstand the most adverse conditions and ensures reliable operation.

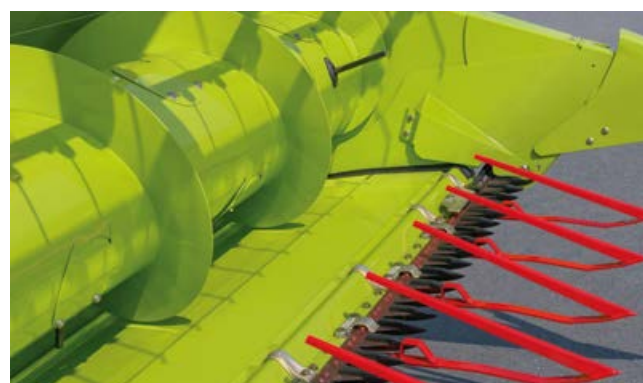

Cutterbar table retracted – grain (-100 mm)



Cutterbar table extended – grain (+100 mm)



Quick and easy replacement of dividers



Easy adjustment of divider height using the panel key

The VARIO cutterbars.

VARIO 1380 / 1230 / 1080 / 930 / 770 / 680 / 620 / 560 / 500



VARIO cutterbars.

VARIO cutterbars from CLAAS are synonymous with the best cutterbar table adjustment system in the market. With its VARIO 1380 to VARIO 500 models, CLAAS has made systematic enhancements to its proven VARIO cutterbar range.

The highlights at a glance:

- Integrated rapeseed plates allow infinite adjustment within an overall range of 700 mm for grain and rapeseed
- Large, 660 mm diameter intake auger for optimal crop flow
- Reel optimised to reduce stalk take-up
- MULTIFINGER intake auger
- Quick-release mounting system allows crop dividers and rapeseed knives to be fitted/removed without tools
- Crop lifters with quick-release fasteners
- Automatic parking and transport position
- Automatic operating position

VARIO cutterbars.

Field of use.

The new generation of VARIO cutterbars is the first choice for harvesting cereals and rapeseed. It is ideally suited to deliver high performance and high area output, whether operating in low or high-yield regions. The ability to adjust the VARIO cutterbar table for cereal harvesting (short or long straw varieties) and rapeseed ensures an optimal crop flow at all times and therefore results in an increase in total machine performance of up to 10%.

The wide range of models, from the VARIO 1380 to the VARIO 500, allows the LEXION, TRION and AVERO to use VARIO cutterbars.

Technology.

- Cutterbar table with integrated rapeseed plates
- Table position adjustable from - 100 mm to + 600 mm using the multifunction control lever
- Cutterbar table with infinitely variable overall adjustment range of 700 mm
- Knife drive shaft with automatic telescopic function
- Continuous knife bar and continuous reel (VARIO 930 to VARIO 500)
- Front attachment mechanical drive on one side (VARIO 930 to VARIO 500)
- Intake auger and knife bar mechanically driven via gearbox and drive shaft
- Reel with optimised reel tine carriers, wear-resistant tine tube bearings and a new design to reduce risk of wrapping and stalk take-up
- Angled cross-tube for a better view of the cutterbar table from the cab
- Infinitely adjustable intake auger height
- Reversible feeder housing and intake auger
- Stripper bars adjustable from the outside
- LASER PILOT for automatic steering system can be folded and adjusted without tools

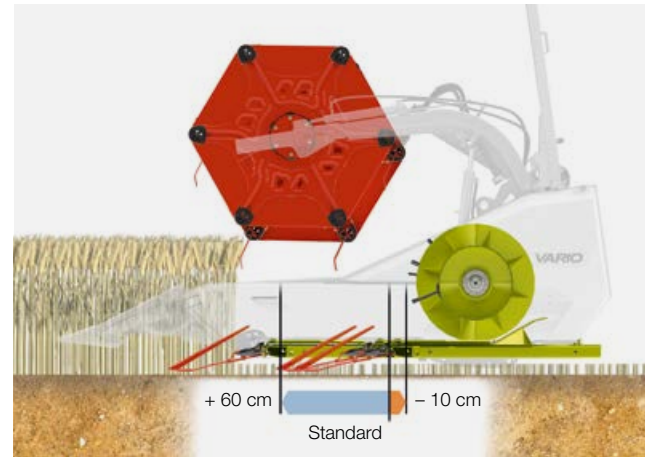

Cutterbar table retracted – grain (-100 mm)



Cutterbar table extended – with rapeseed knives (+ 600 mm)



Plug & play for rapeseed. VARIO 930 / 770 / 680 / 620 / 560 / 500.

Thanks to the rapeseed plates integrated in the cutterbar table and the ability to fit the rapeseed knives without tools, conversion to rapeseed harvesting takes only a matter of minutes. Connecting the rapeseed knives to the hydraulic system automatically activates the hydraulic pump which drives the side knives. The connection is made easily with two flat-seal couplings.

- The hydraulic pump is switched on and off automatically
- Even with the rapeseed knives fitted, the table can still be extended or retracted by 150 mm
- A locking transport container on the attachment trailer allows the rapeseed knives to be carried securely and saves weight on the cutterbar

Use in rice.

The VARIO cutterbars are equipped ex factory - or can easily be converted - with a coated feed roller and a rice harvesting system for optimal performance in rice.



Rugged drive train. VARIO 930 / 770 / 680 / 620 / 560 / 500.

A planetary gear system ensures that the knife bar drive runs extremely smoothly. When the cutterbar table position is changed, the drive shaft adjusts telescopically at the same time, thus allowing work to continue in any position without the need for operator intervention.

The feed roller and knife drive are protected by individual overload clutches. This system allows the VARIO cutterbar to withstand the most adverse conditions and ensures reliable operation.



Rapeseed knives fitted by means of quick-release mounting system

The VARIO cutterbars

VARIO 1380, 1230 and 1080.



Optimal crop flow.

The VARIO cutterbars from CLAAS are designed for the most demanding field conditions. An optimal crop flow, clean cutting and a robust design are the defining characteristics of the three largest models, the VARIO 1380, 1230 and 1080. For these working widths, CLAAS uses the principle of the divided reel and intake auger as well as a divided knife bar.

Ever since its introduction in 2009, this system has proved to be the ideal solution under all conditions for the high throughput associated with the most powerful LEXION combine harvesters. The crop flows from both halves of the cutterbar are combined at the centre of the cutterbar. The outstanding strength and ruggedness required to handle such large quantities of harvested material have made the VARIO cutterbars the benchmark for the industry.

Precise adjustment produces the best results.

Uninterrupted crop flow starts right at the cutterbar, with the correct height setting of the intake auger being a particularly important factor.

- Hydraulic adjustment of the intake auger
- Operation via CEBIS
- Adaptation to crop type and conditions

The stripper bars in the cutterbar trough can also be adjusted conveniently from outside.



The drive train.

Thanks to the mechanical drive via drive shafts, gears and large chains, the drive train is extremely efficient and requires little maintenance. The synchronised knife drive makes for a very smooth-running cutterbar. An overload clutch protects the entire drive train in the event of the intake auger becoming jammed. The knives are driven by gears on the left and right sides and are also protected by overload clutches.

Automatic reel draft control.

The hydraulic reel drive allows the tractive power required by the reel to be adjusted automatically to cope with difficult harvesting conditions, such as lodged crops. This is achieved through an automatic height control system which operates on the basis of the programmed pressure and sensitivity levels to maintain the crop flow at all times.



Fast conversion to rapeseed.

Thanks to the integrated rapeseed plates and the ability to fit the rapeseed knives without the need for tools, conversion to rapeseed harvesting takes only a matter of minutes. The mechanical rapeseed knives are 33% lighter and provide 50% more cutting force. The entire adjustment range is available even with the rapeseed knives attached. The converted cutterbar still remains compact for transport.

Stabiliser wheels for improved ground adaptation.

In order to harvest at high speeds or on very uneven ground, you can fit two robust stabiliser wheels. These damp the movement of the cutterbar and so assist the AUTO CONTOUR ground adaptation. The height can be adjusted without tools. The integrated gas spring bears the entire weight of the stabiliser wheel during the setup procedure, thereby simplifying the task of the operator.



Equipment that makes you even more productive.



Crop lifters can be replaced quickly.

All the crop lifters have tool-free quick-release mounts which allow them to be fitted and removed extremely easily and rapidly. You can therefore count on your cutterbar being ready for action again quickly if the crop lifters are damaged or have to be replaced when changing to harvesting a different crop.



Intake auger fingers replaceable without tools.

All CERIO and VARIO cutterbars are equipped as standard with intake auger fingers which can be replaced without tools. The quick-release mounts can be accessed easily through the large maintenance openings in the intake auger. As a result, any repairs which may be necessary can be carried out in a very short time.



Additional sensor bands.

On the CERIO 930-560 and VARIO 1380-500 models, an additional, third pair of sensor bands detects the position of the cutterbar right in the centre. This feature ensures that AUTO CONTOUR always seeks the optimal cutterbar position and allows a precise stubble profile to be maintained, even when operating with large working widths or in very uneven terrain.



Powerful work lights.

The lighting package provides good all-round visibility when operating in the dark and using large working widths. Work lights on the left and right sidewalls illuminate the crop edge. The work lights at left and right on the back panel allow the stubble immediately behind the cutterbar to be monitored.



Clearly visible reel indicator.

A large indicator fitted on the reel support bracket is easily visible from the operator's seat. It provides a precise reading of the current horizontal position of the reel and makes retrieval of previously stored positions quick and easy.



Reliable transport of crop lifters.

Fitted on the back panel of the CERIO and VARIO cutterbars is a transport bracket for crop lifters which can be accessed safely in the parking position. You can therefore react quickly to different harvesting conditions and always have a sufficient store of crop lifters on board.

Rice harvesting with the VARIO and CERIO cutterbars.



The right equipment for a tough job.

Rice stalks are extremely tough. To achieve clean, top quality cutting results at a high rate in this hard and unforgiving material, the VARIO 930-500 and the CERIO 930-560 cutterbars can be adapted to the conditions.

Special knife guards and adjustable crop guards help ensure efficient cutting under even the most adverse conditions.



An impressive line-up.

Various cutterbar widths with matching rice components are available for the TRION and LEXION series. They are identical to the standard cutterbars of the corresponding models with regard to function and operation.

The high-performance VARIO cutterbars from CLAAS are also available with rice harvesting components to enable quick adjustment to changing harvesting conditions.

Hardened intake auger.

During rice harvesting operations, the machine has to cope with an excessive amount of dirt. To inhibit premature wear, the hardened intake auger has sintered edges.

The speed of the intake auger is reduced to ensure optimal feeding of the green and heavy rice plants.



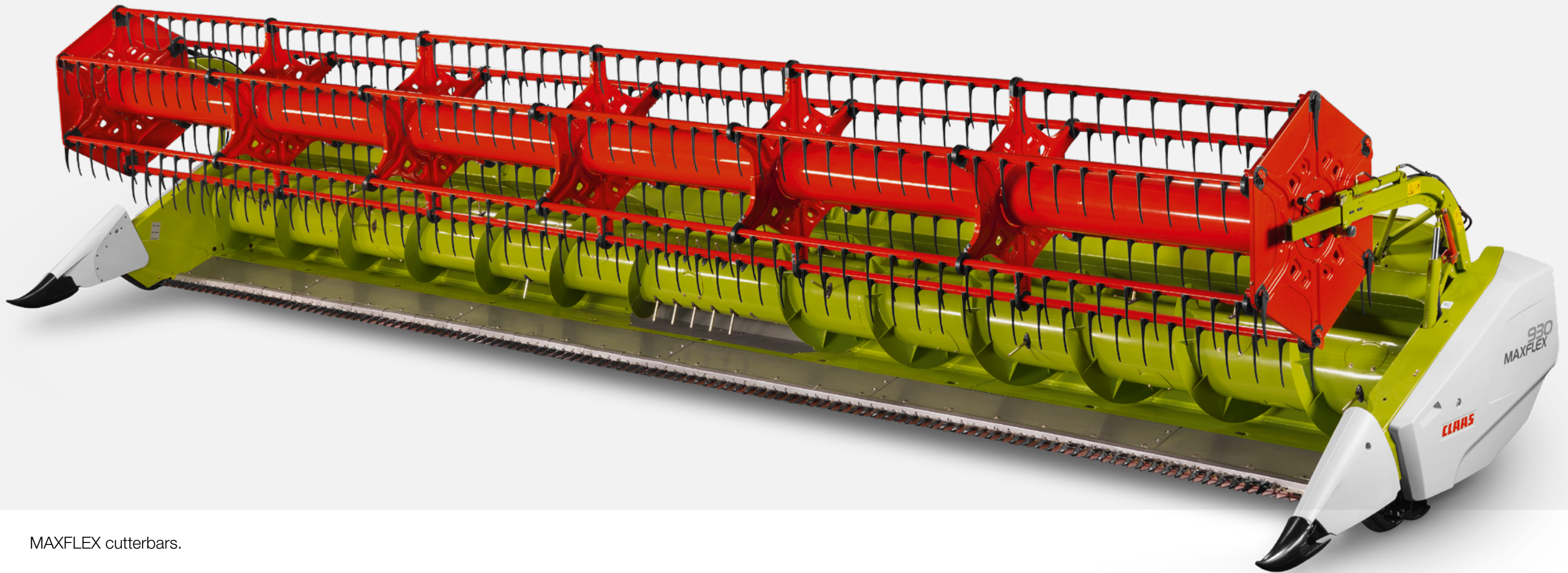

MAXFLEX cutterbars.

The 930 to 560 MAXFLEX cutterbars offer you the perfect solution for harvesting crops close to the ground. Their unique multicrop capability for grains and soybeans also results in high flexibility and makes them extremely user-friendly when harvesting a variety of different crops.

The highlights at a glance:

- 180 mm flexible knife bar
- Knife bar is suitable for soybeans and grains (multicrop capability)
- Electrohydraulic system allows flexible knife bar to be set to rigid configuration and returned to flexible mode again from the cab
- Large, 660 mm diameter intake auger for optimal crop flow

- Reel optimised, lowest risk of wrapping
- MULTIFINGER intake auger
- New type of flexible reel tines for working close to the ground
- Table locked hydraulically from the cab
- Stainless steel bottom plate in flexible area as standard



Field of use.

Legumes, such as soybeans, peas and lentils, grow in pods close to the ground. It is therefore important to cut the crops as close to the ground as possible at harvest time. In this way, every last pod gets picked up by the machine and cutterbar losses are effectively prevented.

Technology.

- 180 mm flexible knife bar
- Electrohydraulic system allows flexible knife bar to be set to rigid configuration (for use in grains) and returned to flexible mode again (soybean harvesting) via the multifunction control lever or directly on the cutterbar
- Cutting angle adjustment for different conditions via HP feeder housing and V feeder housing
- Stripper bars adjustable from the outside
- Optional grain baffle to avoid bouncing grain loss
- Infinitely adjustable intake auger height
- LASER PILOT for automatic guidance can be folded and adjusted without tools
- Compatibility with grain thanks to grain sensors, crop lifters and grain cutting system
- Stainless steel bottom plate in central area of cutterbar table
- Automatic parking and transport position
- Automatic operating position



Optimised settings.

Adjustable skids for reliable front attachment guidance and cutting height adjustment.



Just follow the ground.

Skids with integrated AUTO CONTOUR system for perfect adaptation to ground contours across entire working width.



Reliable cutting.

For clean cutting, even under adverse conditions (e.g. moist plants, weeds), the short knife guards are open at the front.



Great versatility.

Front attachment guidance when harvesting grain can be provided by equipping the left and right sides each with a pair of AUTO CONTOUR sensors.



Grain harvesting equipment.

Short, closed knife guards make it possible to fit crop lifters.



Special short soybean crop dividers can deflect upwards



Stowage position for crop divider points during transport

CONVIO FLEX / CONVIO.

The draper cutterbar.

CONVIO FLEX / CONVIO 1380 / 1230 / 1080 / 930 / 770

Powerful cutterbar for all crops.
Draper cutterbars for higher
performance.

Draper cutterbars are used wherever low-growing and low-fruited stalk crops or difficult conditions (lodged grain crops, volunteers) necessitate very low cutting. The flexible cutterbar table ensures optimal ground contour following, even with large widths, while the belts make for a gentle and even crop flow.





Innovative reel for the highest throughput. New reel design.

The newly developed reel with its innovatively shaped, adjustable cam track allows the reel tines to pick up the crop before it is cut, thereby keeping front attachment losses to a minimum, especially in lodged grain. In short crops in particular, the tines optimise the feeding of the crop into the cutterbar. In addition, the unique flip-over concept prevents the crop from wrapping on the reel. In this way, the crop is fed efficiently, consistently and with minimal losses onto the belts of the CONVIO cutterbar, from where it is delivered evenly into the combine harvester.

Automatic reel draft control.

The hydraulic reel drive allows the tractive power applied by the reel to be adjusted automatically to cope with difficult harvesting conditions, such as lodged crops. This is achieved through an automatic height control system which operates on the basis of the programmed pressure and sensitivity levels to maintain the crop flow at all times.



Cam-track-controlled reel with flip-over concept

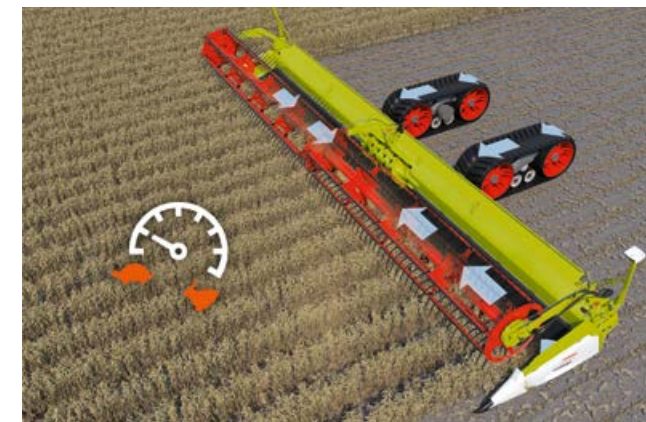

AUTOMATIC BELT SPEED for the conveyor belts.

The AUTOMATIC BELT SPEED operator assistance system adjusts the speed of the belts to the harvesting speed continuously and completely automatically.

Advantages for the operator:

- 1 Constant, automatic adjustment of the belt speeds, especially in uneven crop stands
- 2 Speeds are always set correctly for an even crop flow

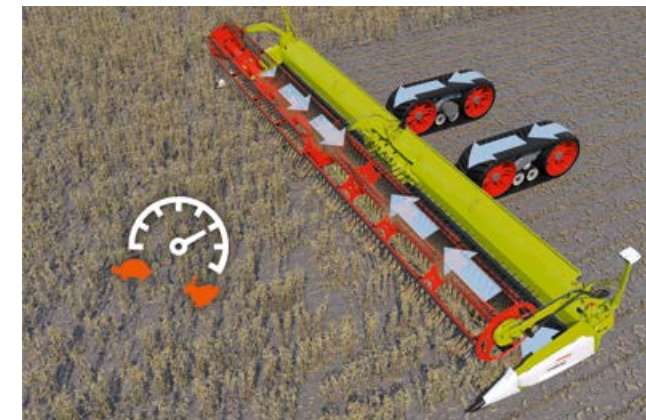

Reversing function for critical situations.

Two reversing modes are available to ensure that it is possible to respond to the specific requirements of any situation: the button on the armrest reverses the reel, centre belt, intake auger and feeder housing, the button on the multifunction control lever reverses the centre and side belts while on the move.

In the event of belt slippage, the early warning system is triggered: this allows the operator to identify and intervene in critical situations at an earlier stage. Furthermore, the operator can monitor the correct load status of the belts – even at dusk or at night.



Reversing via CMOTION (1) or by simultaneously pressing the toggle switch and the reversing button (2)

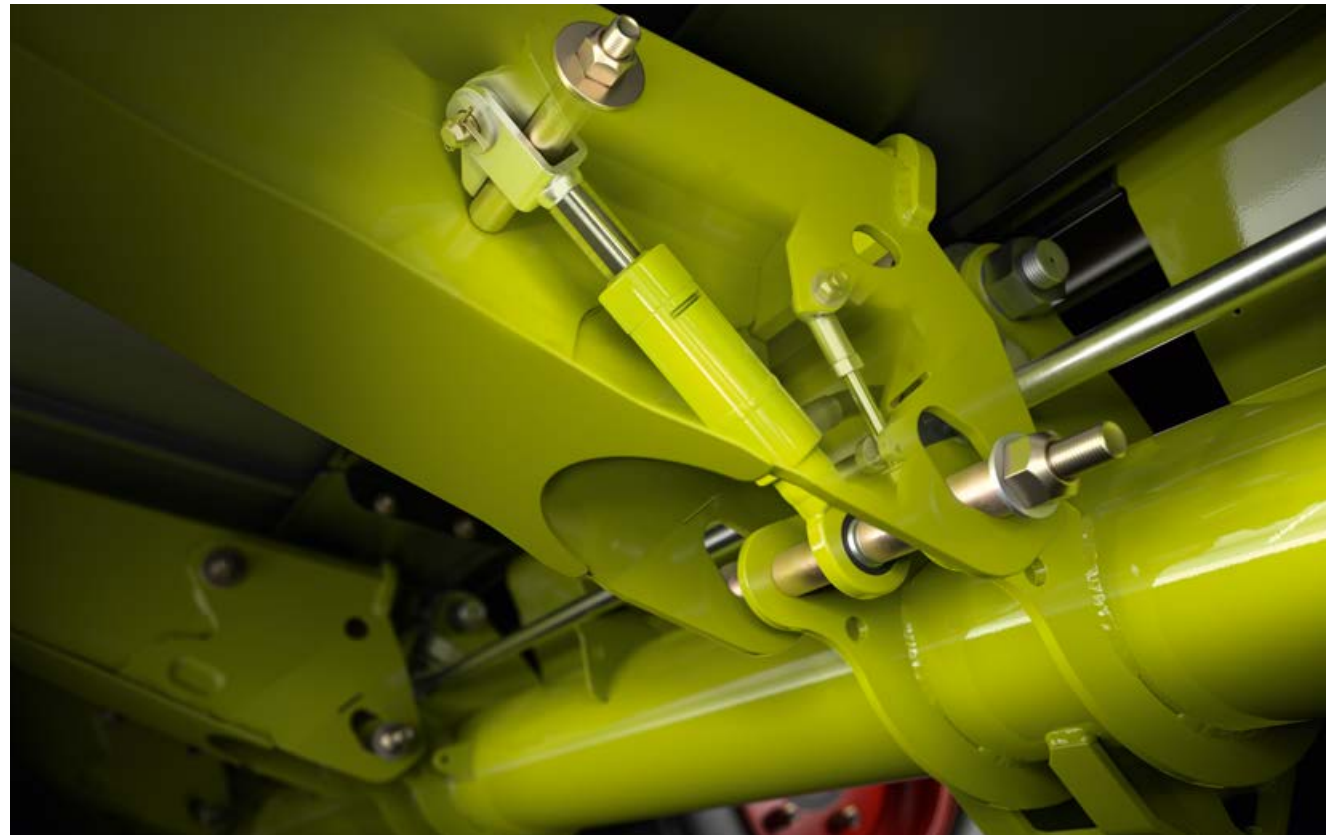

Optimal support for productive operators.
ACTIVE FLOAT for the knife bar.

CONVIO FLEX is equipped as standard with the ACTIVE FLOAT hydropneumatic suspension. This suspension system allows the ground pressure of the knife bar to be adjusted to the field conditions from the cab while on the move.

Advantages for the operator:

- 1 Precise cutterbar guidance close to the ground through optimal ground pressure
- 2 Ideal when working in conditions where there is a rising moisture level – as in the case of morning or evening dew, for example

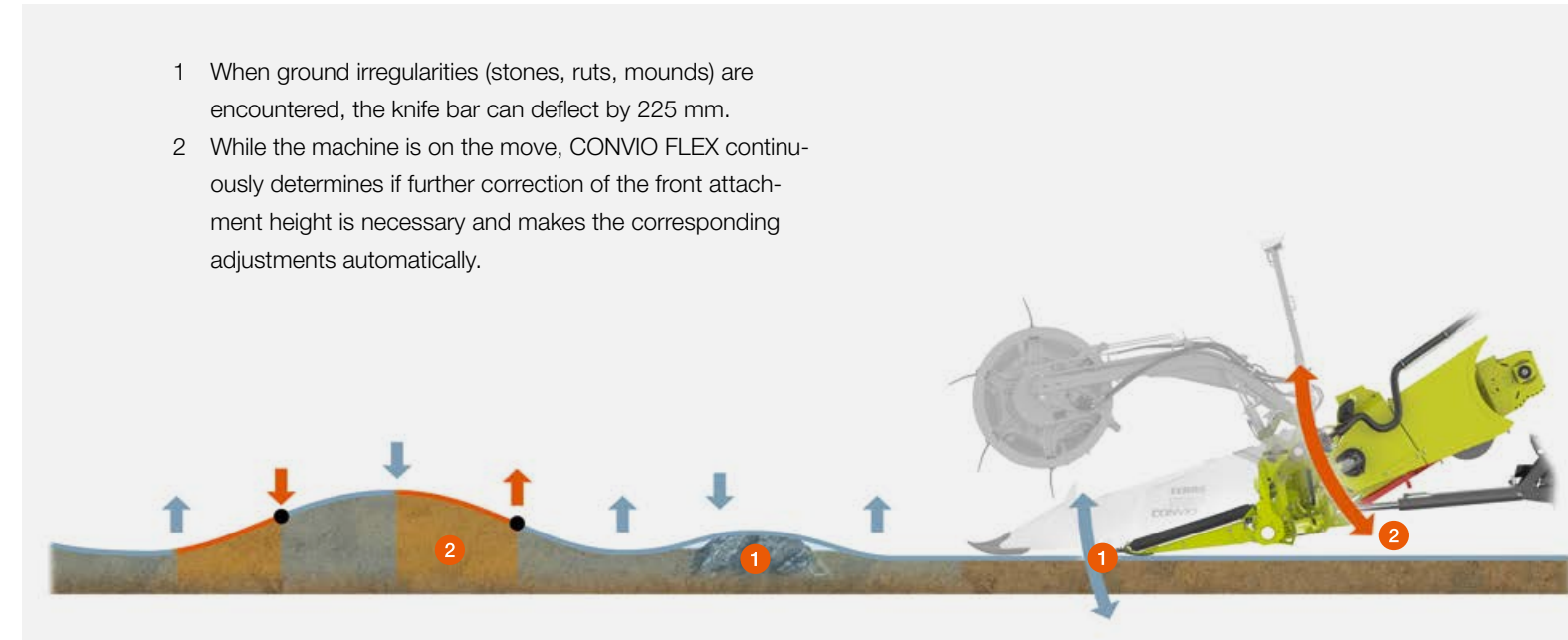

- 1 When ground irregularities (stones, ruts, mounds) are encountered, the knife bar can deflect by 225 mm.
- 2 While the machine is on the move, CONVIO FLEX continuously determines if further correction of the front attachment height is necessary and makes the corresponding adjustments automatically.

Maximum flexibility
for all ground contours.

Maximum reduction in operator workload with optimal cutting performance – CONVIO FLEX can be used in four different modes:

1 Grain mode.

Cutterbar table and knife bar are set to a rigid configuration.

2 Lodged grain mode.

The knife bar is rigid but can be changed to flexible mode with a touch of a button while on the move. This is especially useful for avoiding crop losses when dealing with isolated lodged crop areas during grain harvesting.

3 Manual flex mode.

When manual flex mode is activated, the knife bar resting on its skids but exerting no ground pressure follows the ground contours. The flexible knife bar can avoid obstacles with a 90 mm upward deflection and also follow the ground contours with a downward deflection of 135 mm. With a total flex range of 225 mm, CONVIO FLEX is therefore able to adjust to practically all ground conditions.

4 AUTO FLEX mode.

AUTO FLEX is a self-learning system which automatically optimises the height of the front attachment on the basis of the ground contours and thereby offers a number of important advantages:

- The greatest possible downward flex range is always available
- The knife bar is always maintained as close as possible to the reel
- The lowest cutting height is achieved



Powerful drive (1).

The drive train of the cutterbar consists of two parts. The mechanical part drives the intake auger and knife bar while the hydraulic part drives the side belts, the centre belt, the reel and the rapeseed knives. An overload protection feature protects the entire drive train against damage.

Powerful reversing.

Powerful mechanical reversing of the intake auger and the feeder housing is possible when these units are stationary.

- It is also possible for the side belts and centre belt to be reversed under full load
- Slow, gradual starting following reversing

Linear drive of knife bar (2).

Depending on the working width, the linear drive is transmitted to the knife bar by one or two planetary gear units.

- One-piece knife bar with planetary gear unit on the left-hand side of the machine for the 9.30 m and 7.70 m models
- Divided knife bar, each section having a separate planetary gear unit for the 13.80 m, 12.30 m, 10.80 m and 9.30 m (optional) models
- Both halves run synchronously and in opposite directions

Side belts have a straight path.

Two guide pulleys allow the side belts to be tensioned centrally without tools. The required degree of belt tension can be read off the indicator.

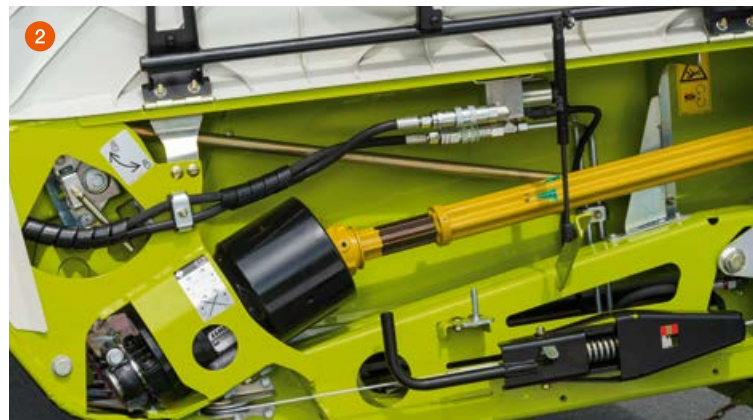

Plug and play for rapeseed harvesting.

The hydraulically powered rapeseed knives can be fitted without the use of tools in a matter of minutes. Once the rapeseed knives are fitted, the feed augers are activated automatically and the cutterbar is ready for rapeseed harvesting.



The straight belt path and the correct belt tension ensure the durability of the belts



Crop dividers and knife bar indicator.

Special crop dividers (3) are available for use when harvesting crops such as soybeans, peas or beans which grow close to the ground. The crop dividers are spring-mounted and follow the ground contours. The ground pressure can be adjusted continuously by means of a spring. In particularly long-growing crops, you can extend the crop divider by adding a second one.

It is important to know the current position of the cutterbar in order to be able to optimise the ground contour following performance continuously. The position is indicated on a large scale (4) on the right-hand side of the machine. This allows you to see the current value clearly at any time from the comfort of the cab.

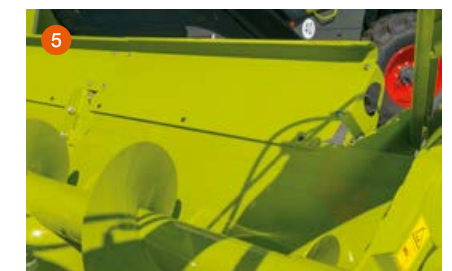

The raised rear wall (5) prevents bouncing grain losses when harvesting rapeseed



Smooth cutterbar guidance.

Hydropneumatically suspended stabiliser wheels prevent the cutterbar from rocking when operating in uneven terrain. This feature also ensures smooth cutterbar guidance at high ground speeds and enhances driving comfort.



Stabiliser wheels guide the cutterbar smoothly under all conditions

Crop lifters can be replaced quickly.

All the crop lifters have tool-free quick-release mounts which allow them to be fitted and removed extremely rapidly. You can therefore count on your cutterbar being ready for action again quickly if the crop lifters are damaged or have to be replaced when changing to harvesting a different crop.

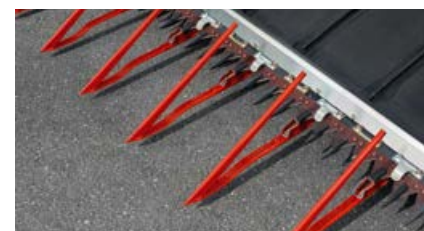

The crop lifters can be replaced quickly without tools

Powerful work lights.

The lighting package provides good all-round visibility when operating in the dark and using large working widths. Work lights on the left and right sidewalls illuminate the crop edge. The work lights at left and right on the back panel allow the stubble immediately behind the cutterbar to be monitored.

Brightly illuminated crop flow.

Powerful work lights illuminate both side belts in the cutterbar trough. This allows you to continue to monitor – and if necessary optimise – the crop flow on the belts when operating during the hours of darkness.



Powerful work lights illuminate the cutterbar and trough perfectly



Folding cutterbars.

In smaller-scale settings in particular, there are many advantages associated with a compact cutterbar which can be deployed quickly and remain on the combine harvester.

The highlights at a glance:

- Transport width of 3.0 m
- No additional trailer necessary
- Front attachment mechanical drive
- MULTIFINGER intake auger
- Controls for folding mechanism by access ladder outside cab
- Full AUTO CONTOUR capability
- Very good view through folding mechanism in direction of travel

Field of use.

The folding cutterbars do away with the need to attach and detach the cutterbar. At the same time, they ensure optimal handling during travel with outstanding visibility and enable transfers from field to field with practically no interruption. Whether you are negotiating field tracks, narrow roads or dense traffic, the folding cutterbars allow you to benefit from a commanding view and excellent transport characteristics.

Technology.

- Divided knife bar and divided reel
- Front attachment mechanical drive on one side
- Intake auger and knife bar mechanically driven via gearbox and drive shaft
- Infinitely adjustable intake auger height

Transport.

The compact design ensures optimum visibility and excellent manoeuvrability in very restricted spaces while taking into account the permissible transport width.

Folding.

The fully hydraulic folding function is activated at the touch of a button. The strong, sectional frame construction makes for precise actuation and ensures long-term operating reliability.

Harvesting.

The folding cutterbar is ready for action in a matter of seconds. Move the dividers into position, engage the drive shaft and you are ready to go.



Travel position



Ready for use with just a few adjustments



Compact dimensions



CORIO CONSPEED and CORIO.

The CORIO and CORIO CONSPEED maize pickers are equipped with established technologies as well as unique new features.

The highlights at a glance:

- 17° operating angle to prevent cob losses
- Straight (CORIO) and conical snapping rollers (CORIO CONSPEED)
- Robust drive train in all CORIO models
- Specially shaped hoods for gentle crop handling
- Unique folding system for hood tips reduces the length of the picker on the road by almost 80 cm
- Feeder chain is easy to change and tension
- Replaceable wear parts integrated in hoods
- CORIO CONSPEED maize picker as 12, 8 and 6-row unit
- CORIO maize picker as 8, 6, 5 and 4-row unit
- Row widths of 90, 80, 75 and 70 cm

Field of use.

The CORIO CONSPEED and CORIO model series are the maize pickers for harvesting grain maize or corn cob mix. Whether working in high-yield crops or very dry maize stems, the CORIO CONSPEED and CORIO maize pickers ensure a clean, effective picking process, from the LEXION to the AVERO.

Thanks to the new folding mechanism for the hood tips, the length of the CORIO and CORIO CONSPEED models can be reduced by almost 80 cm for road transport. This makes for safe road travel, even when negotiating junctions and field exits where visibility is restricted.

Functional principle.

The hoods ensure that the maize stalks are fed evenly and gently into the snapping rollers. The stalks are captured by the rollers and pulled downwards. At the same time, snapping plates separate the maize cobs cleanly from the stalks.

Horizontal choppers operating at a constant speed chop up the maize stalks once they have been pulled down. The intake auger then transports the maize cobs to the feeder housing.

The central elements of the CORIO CONSPEED and CORIO maize pickers are the snapping rollers which also embody the main difference between the two models.

- CORIO CONSPEED: conical snapping rollers
- CORIO: straight snapping rollers



Technology.

- Efficient, free-running drive for all CORIO CONSPEED and CORIO models
- Quick and easy speed adjustment by changing the combination of gears
- Spiral intakes on the snapping rollers improve stalk intake
- Mechanically or hydraulically adjustable snapping plates allow the cobs to be separated cleanly
- Each snapping gear unit is individually protected against overload and foreign objects
- The drives for the snapping rollers and knives are integrated in the robust gear housing
- Available in rigid or folding versions
- AUTO PILOT and AUTO CONTOUR optionally available for all models
- The horizontal chopper captures plants along the entire length of the picker opening.

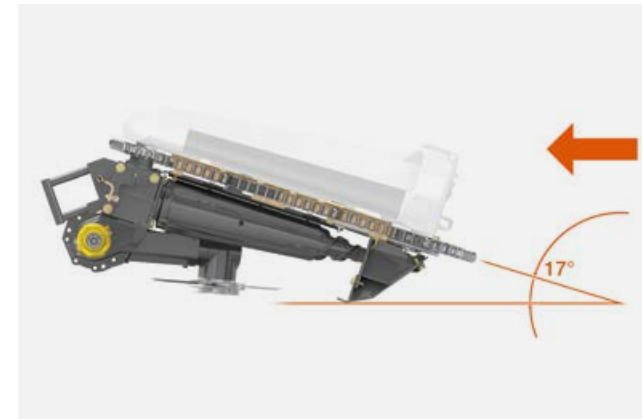

17° operating angle.

At 17°, the CORIO CONSPEED and CORIO models have the flattest operating angle in the market.

- The operating angle has been reduced by approximately 10%
- Reduced cob losses, especially those resulting from "cob jump-off"
- In lodged maize in particular, the flat angle and the new hood shape help make for blockage-free operation



Horizontal choppers.

Each picking unit is equipped with a horizontal chopper integrated in the transmission unit. The position of the chopper knife enables precise chopping of the rest of the plant, resulting in fast rotting and the formation of a consistent seedbed for the following crop.



Top form.

The front part of the hoods has a new, unique shape.

- Even more protective crop handling thanks to the optimised shape of the hoods
- The flanks of the hoods have been designed in such a way that maize stalk capture is delayed to take place at a more flexible point in order to avoid cob losses
- Improved performance in lodged maize



Precise chopping.

Precise chopping encourages the rotting of the crop residues and helps create a consistent seedbed for the following crop.



Maintenance position.

A new concept for opening the hoods provides quick and easy access for maintenance or cleaning. Only a few simple steps are required to put a hood into the maintenance position without tools.



Easy handling.

The conveyor chains can be tensioned and changed quickly, easily and conveniently. Once a hood has been moved to the maintenance position, a simple assembly lever is all that is required to release, tension or replace a chain.



New folding mechanism.

A new design allows the hoods to be folded easily into a compact transport position. As well as being easy to use, the new arrangement makes for better visibility during road travel as it allows the front attachment to be shortened by 80 cm.



Road travel.

Covers and a light bar make for safe road travel in accordance with the relevant traffic regulations.

Rubber cob retainer.

All models are equipped with small rubber cob retainers as standard to prevent cobs from falling out. A large rubber cob retainer is available as an option to enable loss-free harvesting even in tall crops. Fitting and removal can be performed by means of a quick-mounting system on each hood.



Integrated wear parts.

Replaceable wear parts are integrated on the right and left sides of the hoods. When worn, the individual parts can be replaced instead of the entire hood.



Sunflower kit.

Simply turning round the feeder chain is all that is required to switch over quickly for sunflower harvesting. In addition, rigid knives are fitted on the snapping plates along with side hood extensions and a raised rear wall panel.



Snapping plate adjustment.

Depending on the model, a mechanical or hydraulic snapping plate adjustment system is fitted as standard. The hydraulic variant, which allows convenient adjustment from the operator's seat, can also be added as an option.

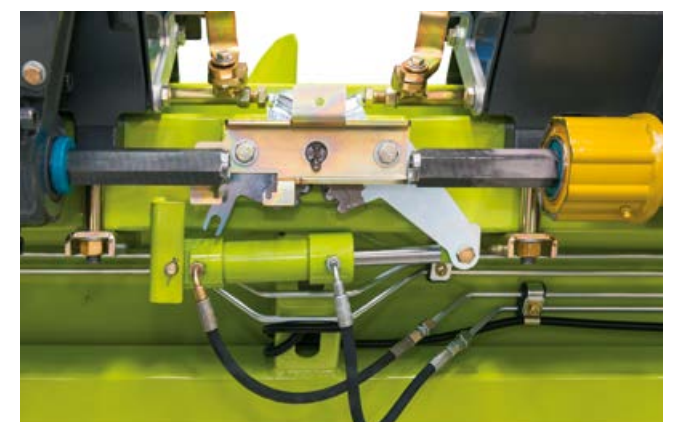

CORIO CONSPEED

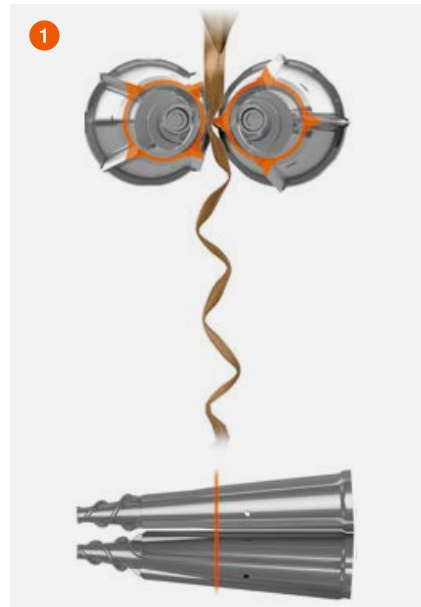

CORIO CONSPEED

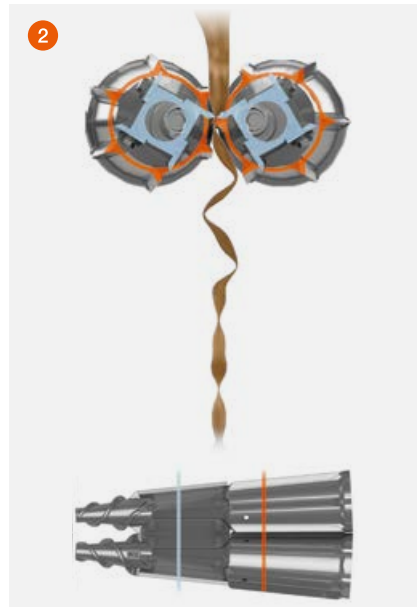

CORIO

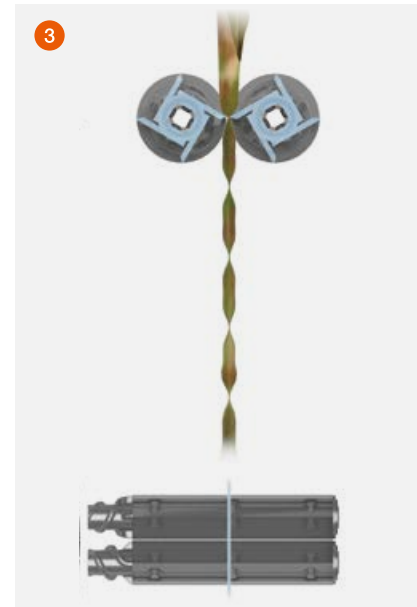

Conical – CORIO CONSPEED.

- Conical snapping rollers
- Hybrid or standard snapping rollers available
- Four bolt-on knives are fitted on the front section of each hybrid snapping roller
- Tungsten carbide coating ensures high wear resistance
- Horizontal chopper can be switched off

Straight – CORIO.

- Straight snapping rollers (forward mounted bearings)
- Snapping roller knives along entire length
- Four bolt-on knives per snapping roller
- Horizontal chopper is driven continuously

Recommended uses.

Depending on the region and climate, the maturity of the maize plants varies at the time of harvest. CLAAS therefore offers a range of snapping rollers in order to enable the best possible picking performance.

1 With a uniform profile.

This roller shape is particularly suited to dry conditions. The profiles of the two rollers engage and the plants are pulled downwards very gently. In dry conditions, in particular, this arrangement prevents early detachment of the plants.

2 Hybrid snapping rollers.

The special snapping rollers are particularly suited to green crops. Four knives, which aggressively pull the thick stalk sections downwards, are bolted to the front end of each hybrid snapping roller. The rear end of the hybrid snapping rollers has the standard profile.

3 Straight – CORIO.

The straight snapping rollers can be used universally. The throughput speed of the maize stalks remains constant during picking.

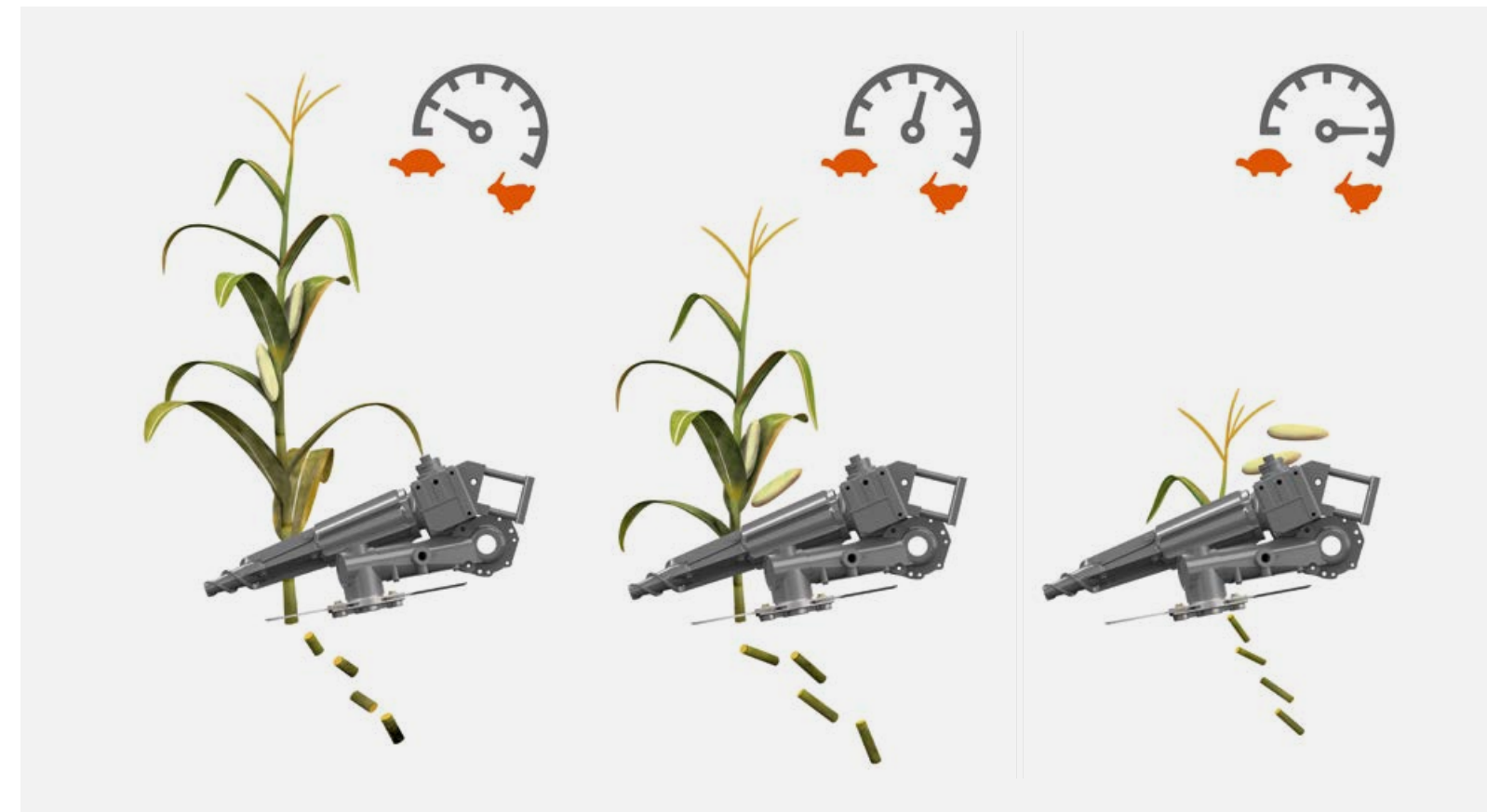

Operating principle of conical rollers.

The key characteristic of the conical snapping rollers is that the speed with which each maize plant is pulled through the rollers increases as the diameter of the roller increases. In this way, even at higher ground speeds, the plant is drawn in gently at first and then more quickly. This means that it is possible to avoid cob losses as well as unnecessary plant residues in the machine resulting from the plants being broken off.

Advantages for you.

- Top chop quality thanks to the low throughput speed at the lower end of the maize stalk
- Avoidance of cob losses and damage through breakage thanks to the gradual increase in throughput speed
- Less straw and plant residue in the machine means higher throughput and therefore makes it possible to attain a higher ground speed





SUNSPEED.

The SUNSPEED sunflower cutterbars impress with their unique picking concept, very high output per unit area with the lowest losses and ease of operation.

The highlights at a glance:

- SUNSPEED sunflower front attachment available as 16, 12 and 8-row unit
- Harvests flower heads exclusively - stalk-free picking concept
- The height and speed of the reel can be synchronised to the ground speed conveniently from the cab
- Adjustable guide plates keep the stalks securely in position
- The gap between the shuttles can be adjusted to the stalk thickness
- The seed pans can be adjusted for tilt

Field of use.

The SUNSPEED sunflower cutterbar is the optimal solution for sunflower harvesting. The unique functional principle enables a significant reduction in both the load on the threshing system and the degree of cleaning required to remove non-grain constituents.

Its high degree of versatility with regard to different row widths and stalk thicknesses makes the SUNSPEED the universal front attachment for sunflowers.



Adjustable shuttles

Technology.

- Knife drive features a low-maintenance oil-bath transmission
- High cutting frequency of 1,200 strokes per minute
- Snapping roller and intake auger are driven by chains and belts
- Seed pan width adjustable by up to 20 mm
- Shuttles up to 1,800 mm long for even stalk guidance
- Adjustable circumferential reel speed
- Adjustable intake auger speed
- Automatic adjustment of reel speed based on ground speed



Snapping roller



Reel and intake auger



Functional principle.

Once the sunflowers are collected by the seed pans, the adjustable guide plate ensures that the flower heads are pushed forwards. At the same time, the snapping roller below the knife bar pushes the stalks downwards. In this way, the guide plate and snapping roller prevent the stalks from being cut too soon. The cut is not performed until the sunflower heads are captured by the reel. As a result, only the flower heads reach the intake auger which finally delivers them to the feeder housing.

This unique functional principle makes for:

- Lower fuel consumption
- Increased threshing and cleaning performance
- Low wear of all components

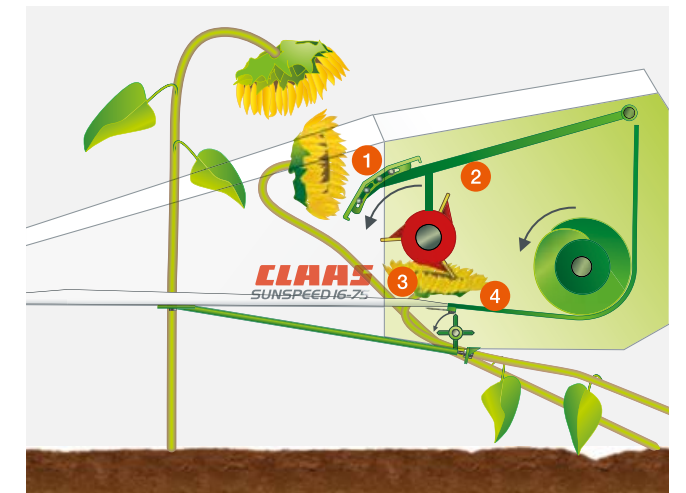

- 1 Adjustable guide plate
- 2 Reel
- 3 Knife bar
- 4 Snapping roller



SWATH UP.

The SWATH UP is the front attachment for clean and reliable swath pick-up.

The highlights at a glance:

- Loss-free crop pick-up
- Universal front attachment for different crop types
- Pick-up belts for consistent swath pick-up
- Effective avoidance of stone pick-up thanks to castor guide wheels
- Working speed is automatically controlled via ground speed



Field of use.

SWATH UP demonstrates its abilities in areas which are unsuited to direct threshing - and it does so under all imaginable conditions. It enables the pick-up of nearly all windrowed crops, especially crops such as rice, rapeseed and grass seed, and provides yet another demonstration of the exceptional efficiency of CLAAS front attachments.

Functional principle.

The pick-up tines on the front belt module ensure clean and loss-free collection of the harvested crop. The crop is transferred to the rear belt unit which conveys it to the feed roller. Guide blocks and guide rollers ensure that the belt modules are positioned and tensioned precisely if unevenly loaded, thereby avoiding losses. The feed roller ensures a clean transfer to the feeder housing.



Technology.

- Four wide, interlinked pick-up belts form the front belt unit (with pick-up tines)
- Four wide, interlinked transfer belts form the rear belt unit
- Driven via chains and belts
- Pick-ups controlled by bevel gear
- Speed of intake units can be adjusted continuously from inside the cab
- The working speed is controlled automatically via the ground speed
- Rake unit is suspended (coil springs and gas-filled spring struts)
- Working depth can be set by castor guide wheels
- Seals between pick-up belts and frame prevent leakage losses



Crop guard.

The crop guard ensures efficient crop flow. It can be adjusted hydraulically for height and is therefore able to adapt optimally to the most diverse conditions. Furthermore, the distance to the rake unit is adjustable.

Castor guide wheels.

The two castor guide wheels at left and right not only limit the depth but also ensure that the tines do not pick up any stones.



The tines ensure the crop is picked up and passed on quickly



Castor guide wheels limit the depth



Standard feeder housing.

The universal feeder housing is compatible with all crops, avoiding unproductive changeover time. A shallow intake angle to the threshing parts facilitates optimal crop flow. Rugged feeder chains with feeder slats ensure high stability while a replaceable wear plate guarantees long service life.



HP feeder housing.

The HP (header pitch) feeder housing allows manual or hydraulic adjustment of the cutting angle to adapt to all field conditions. From the central position the cutting angle can be moved 8° back and 11° forward.



V feeder housing.

With the flexible positioning of the cutterbar mount, the V feeder housing facilitates fast, easy adjustment of the cutting angle. This ensures optimal adaptation to all field conditions and different types of tyres.

The feeder housing can be equipped with an additional middle support roller. Greater support of the feeder slats in the guide roller increases stability and optimises the guidance of the chain. In addition, an enclosed guide roller is available for use in dry and low-straw conditions. Dust extraction at the feeder housing prevents dust from being stirred up immediately in front of the cab in very dry conditions.



Front attachment drive brake.

Effective protection against foreign objects and other causes of damage: the drive brake (1) allows the front attachment to be stopped immediately if necessary by means of the multi-function control lever. As the drive brake is fitted directly on the feeder housing, only a small mass has to be braked. This means less braking torque and less wear.

Hydraulic reverse.

Blockages are easily cleared: the hydraulic system (2) enables gentle reversing with a high starting torque. The hydraulic reverse can be actuated conveniently via a toggle switch in the cab. The direction of rotation of the hydraulic reel drive also changes automatically, providing additional support for the reversing procedure.

Front attachment interface.

Thanks to their standard interface, CLAAS front attachments can be fitted to LEXION, TRION and AVERO machines and are therefore available in all power categories. What's more, they have a whole series of functions and helpful features which allow them to meet even specialised requirements and so offer you outstanding flexibility. Benefit from the unique combination of high-value performance and equipment features.

Multicoupler.

The central connection coupling for all hydraulic and electronic connections to the cutterbar.

- You gain valuable time due to shorter attachment and removal procedures
- Integrated design means there is no danger of confusion
- Easy to connect, even under pressure
- Environment-friendly with no oil leakage

Central locking system.

A single lever on the left side of the cutterbar operates all locks simultaneously.



Multicoupler and central locking make for extremely convenient operation

Automatic front attachment guidance and front attachment detection.



Automatic front attachment guidance.

In order to ensure optimum following of the ground contours, CLAAS front attachments are equipped with the CONTOUR, AUTO CONTOUR and MULTI CONTOUR automatic front attachment guidance systems for ideal results at all times.

CONTOUR.

The cutterbar with CONTOUR adjusts automatically to ground irregularities along the direction of travel.

- CONTOUR = automatic longitudinal adjustment of the front attachment
- The required cutting height can be set via CEBIS
- The active cutting height is controlled by CONTOUR
- Longitudinal control can be overridden by the operator at any time

AUTO CONTOUR.

AUTO CONTOUR goes one step further and also enables automatic compensation for surface irregularities across the direction of travel.

- AUTO CONTOUR = automatic transverse and longitudinal control of the front attachment
- The required cutting height can be set via CEBIS
- The active cutting height is controlled by AUTO CONTOUR
- Transverse and longitudinal control can be overridden by the operator at any time

Advantages for you.

- Valve-controlled, nitrogen-filled accumulators ensure optimal shock absorption with front attachments of different weights
- Improved front attachment guidance, especially when operating with wide working widths
- Easier front attachment guidance in lodged crops, in darkness and in sloping terrain
- Significant reduction in workload for the operator, enabling greater concentration on threshing



Sensor bands detect the position of the front attachment for AUTO CONTOUR and CONTOUR



Detection on initial contact.

To help prepare your combine harvester more quickly, the VARIO, CERIO, CONVIO and MAXFLEX front attachments provide it with the key data it requires the first time they are attached. The front attachment and ground-contour following characteristics are matched precisely to the machine. This saves operators a considerable amount of time as there is no need for them to repeat set-up and learning procedures.

All four cutterbars provide the following data:

- Front attachment type
- Working width
- Number of sections
- Set values to configure sensitivity of AUTO CONTOUR system: cutting height control, preset cutting height and, where necessary, angle of HP feeder housing
- Height for activation of area calculation

Saved when detached.

All cutterbars automatically save the key data for the next deployment each time they are detached from the machine. These data include the reel advance, the end stops for AUTO CONTOUR, the sensitivity of AUTO CONTOUR and the height for activation of the area calculation. These values are then available to the combine harvester at the next harvest, even if a maize picker is fitted and removed during the intervening autumn period.



Convenient front attachment features.



Automated reel control.

- Circumferential reel speed is adjusted automatically in proportion to the ground speed
- Infinitely variable adjustment and storage of reel speed (between forward, synchronous and after-running settings) relative to the ground speed in CEBIS
- Speed settings can be stored in CEBIS
- Hydraulic overload protection prevents damage

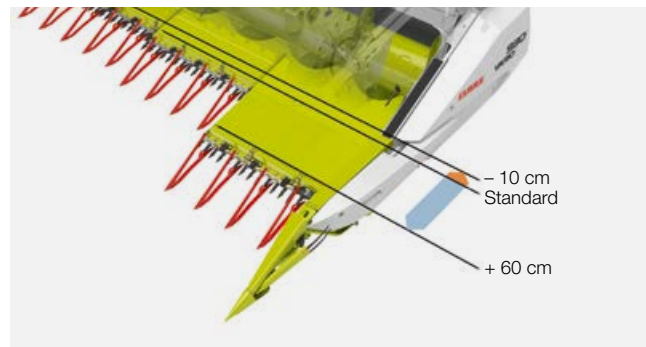

VARIO automation.

- VARIO automation can be switched on or off in CEBIS
- The table length and reel level are then activated or deactivated together

Advantages for you.

- Reduction in operator workload through automatic application of multiple settings
- Optimal adaptation to conditions by means of up to four combinations of settings - for changing crop conditions (such as lodged crops / standing crops) or headland operation and edge mowing - which can be saved separately
- Can be overridden by the operator at any time

Automatic adjustment.

The operator can use the multifunction control lever to store up to four separate combinations of settings. The currently active and the stored combinations of settings can be viewed continuously in CEBIS.

Each combination of settings consists of:

- Reel height
- Reel levelling setting (VARIO cutterbar)
- Table length (VARIO cutterbar)
- Cutting height (with AUTO CONTOUR)
- Cutting angle (HP feeder housing)

All the individual parameters can be overridden manually by the operator at any time, either by a direct input with the multifunction control lever or via CEBIS.



The operator in the cab has a perfect view of the position indicator for the cutterbar tray

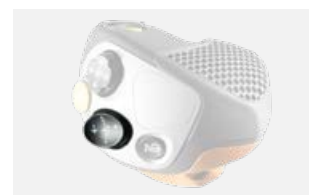

Direct inputs with the multifunction control lever are used to activate cutting height adjustment (AUTO CONTOUR), ground pressure control and cutting height preselection as well as to raise / lower the front attachment



Automatic parking and transport mode.

- Pressing the cutting height adjustment button causes the cutterbar to move automatically into position for stowage on the trailer
- Table moves to 0 mm position (without rapeseed knives)
- Table moves to 450 mm position (with rapeseed knives)
- Reel moves all the way down and to the rear
- In the case of MAXFLEX cutterbars, the knife bar is set to a rigid configuration electrohydraulically (grain harvesting)
- Activation procedure, which takes place with the threshing unit switched off, varies depending on speed:
 - Above 2 km/h: cutting height adjustment button is pressed once
 - Below 2 km/h: AUTO CONTOUR button is held down



Automatic operating position.

- Pressing the cutting height preselection button causes the cutterbar to move to the last operating position automatically
- Table moves to last operating position
- Reel moves to last operating position
- In the case of MAXFLEX cutterbars, the knife bar is released (no longer set to rigid configuration) electrohydraulically (soybean harvesting)
- Activation procedure varies depending on speed:
 - Above 2 km/h: cutting height adjustment button is pressed once
 - Below 2 km/h: cutting height adjustment button is held down
- Reel moves to last operating position
- Table moves to last operating position

Advantages for you.

- Transport and operating positions are reached quickly and easily
- No need to take account of mechanism dependencies



The CMOTION multifunction control lever is used to adjust the VARIO cutterbar table, the MAXFLEX knife bar and the CONVIO conveyor belt speed



The CMOTION multifunction control lever is used to adjust the reel parameters (reel height, reel level) and the snapping plate distance of the maize picker



LASER PILOT.

The electro-optical sensors of the LASER PILOT use pulses of light to scan between the crop and stubble and steer the TRION automatically along the edge.

The LASER PILOT can be folded away for transport and is available for both the left and right side of the cutterbar. Its optimal positioning on the cutterbar side close to the crop edge enables a good viewing angle and ensures high functional reliability even when working with lodged crops, in dusty conditions, on slopes or at night.

Advantages for you.

- The LASER PILOT bracket can be adjusted with the panel key without needing tools
- Easily configured via the LED display
- Can be deployed and retracted without the use of tools
- Available for the left and right side of the cutterbar
- High functional reliability, even when operating in lodged crops, in sloping terrain or in the dark
- Reduction in workload for the operator, enabling greater concentration on threshing
- Greater precision for mapping areas and yields
- Optimal use is made of the full width of the cutterbar
- Increased seasonal performance

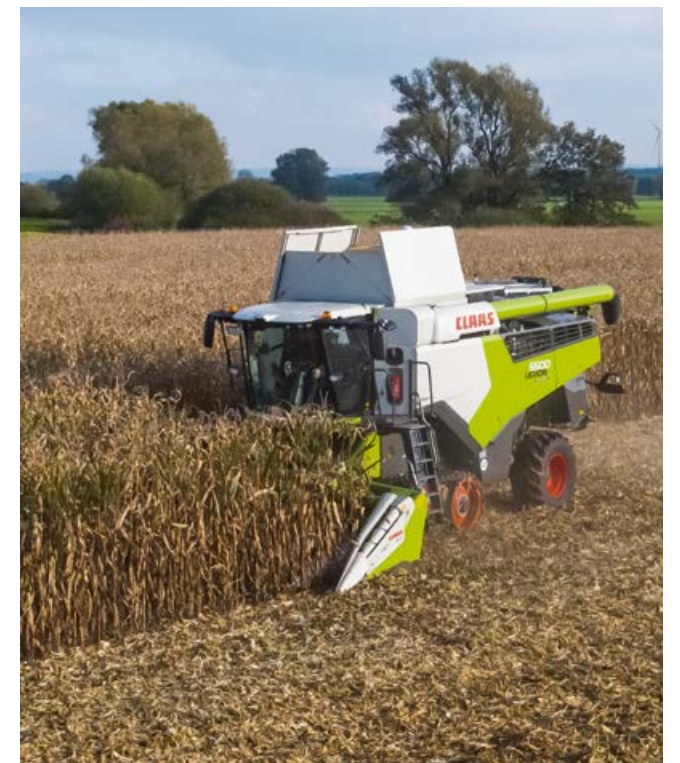

AUTO PILOT.

Two digital sensors incorporated in one of the snapping units detect the position of the combine and automatically guide it through the rows of maize to ensure it is in the optimal position in the crop. In this way, AUTO PILOT contributes to greater performance and increased efficiency.

Advantages for you.

- High functional reliability and safety regardless of visibility conditions
- Optimal use of the full width of the cutterbar
- Increased seasonal performance
- Significant reduction in workload for the operator, enabling greater concentration on threshing

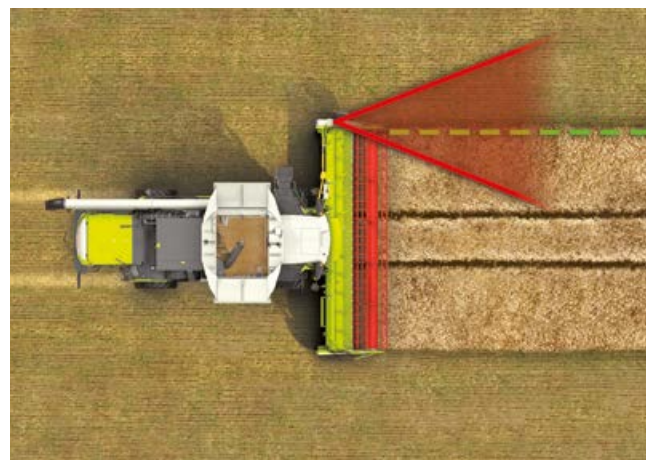

Growing demand for ever greater precision.

The CLAAS front attachments can be equipped with two different automatic steering systems which can be selected as needed, depending on the job in hand.

LASER PILOT – the electro-optical steering system for LEXION and TRION

AUTO PILOT – the electro-mechanical steering system



AUTO PILOT, LASER PILOT and GPS PILOT are activated on the CMOTION multifunction control lever



AUTO PILOT sensor bands

Transport trailers.

Whether operating on roads or farm or field tracks, transport trailers from CLAAS enable fast, easy transfers, even between very distant fields.

The highlights at a glance:

- Transport trailers available ex factory
- Transport speed of up to 40 km/h
- Integrated transport container
- Twin-axle transport trailer with steering rear axle

Single-axle transport trailer.

The single-axle transport trailers are available for the 770 to 370 front attachments.

- Available in braked or unbraked versions for 25 km/h or 40 km/h
- A cutterbar equipped with rapeseed knives can be placed on the trailer without any difficulty

The following options are also available ex-factory:

- Marker lights
- Height-adjustable drawbar

Twin-axle transport trailer.

The twin-axle transport trailers are available for the 1230 to 770 front attachments.

- Available in braked or unbraked versions for 25 km/h or 40 km/h
- Special supports can be fitted to the trailers to allow SUN-SPEED, CORIO CONSPEED and CORIO front attachments to be transported without any difficulty
- A cutterbar equipped with rapeseed knives can be placed on the trailer without any difficulty

The following options are also available ex-factory:

- Marker lights



CORIO 1275 C on twin-axle trailer



Locking transport container for rapeseed equipment

Twin-axle transport trailer with steering rear axle.

The new twin-axle transport trailers with 4-wheel steering are available for the 1230 to 930 front attachments.

- Excellent self-steering characteristics when cornering
- High directional stability
- Available in braked or unbraked versions for 25 km/h or 40 km/h
- The floating front axle adapts optimally to uneven ground
- Special supports can be fitted to the trailers to allow SUN-SPEED, CORIO CONSPEED and CORIO front attachments to be transported without any difficulty
- A cutterbar equipped with rapeseed knives can be placed on the trailer without any difficulty

The following options are also available ex-factory:

- Spare wheels
- Rotating beacon
- LED lights
- Marker lights
- Short or long drawbar

Transport container.

A locking transport container on all attachment trailers allows the rapeseed knives to be carried securely.

Front attachment matrix - cutterbars.

Front attachment	LEXION 8000			LEXION 7000				LEXION 6000				LEXION 5000		
	8900	8800	8700	7700	7600	7500	7400	6900	6800	6700	6600	5500	5400	5300
CERIO cutterbars														
CERIO 930	■	■	■	■	■	■	■	■	■	■	■	■	■	■
CERIO 770	■	■	■	■	■	■	■	■	■	■	■	■	■	■
CERIO 680	■	■	■	■	■	■	■	■	■	■	■	■	■	■
CERIO 620	-	-	-	■	■	■	■	■	■	■	■	■	■	■
CERIO 560	-	-	-	■	■	■	■	■	■	■	■	■	■	■
Standard cutterbars														
C 490	-	-	-	-	-	-	-	-	-	-	-	-	-	-
C 450	-	-	-	-	-	-	-	-	-	-	-	-	-	-
C 430	-	-	-	-	-	-	-	-	-	-	-	-	-	-
C 420	-	-	-	-	-	-	-	-	-	-	-	-	-	-
C 370	-	-	-	-	-	-	-	-	-	-	-	-	-	-
VARIO cutterbars														
VARIO 1380	■ ¹	■ ¹	-	-	-	-	-	-	-	-	-	-	-	-
VARIO 1230	■	■	■	■	■	■	■	■ ¹	■ ¹	■ ¹	-	-	-	-
VARIO 1080	■	■	■	■	■	■	■	■	■	■	■	-	-	-
VARIO 930	■	■	■	■	■	■	■	■	■	■	■	■	■	■
VARIO 770	■	■	■	■	■	■	■	■	■	■	■	■	■	■
VARIO 680	■	■	■	■	■	■	■	■	■	■	■	■	■	■
VARIO 620	-	-	-	■	■	■	■	■	■	■	■	■	■	■
VARIO 560	-	-	-	-	-	-	-	■	■	■	■	■	■	■
VARIO 500	-	-	-	-	-	-	-	■	■	■	■	■	■	■
MAXFLEX cutterbars														
MAXFLEX 930	■	■	■	■	■	■	■	■	■	■	■	■	■	■
MAXFLEX 770	■	■	■	■	■	■	■	■	■	■	■	■	■	■
MAXFLEX 680	-	-	-	-	-	-	-	■	■	■	■	■	■	■
MAXFLEX 620	-	-	-	-	-	-	-	■	■	■	■	■	■	■
MAXFLEX 560	-	-	-	-	-	-	-	■	■	■	■	■	■	■
CONVIO FLEX cutterbars														
CONVIO FLEX 1380	■	■	-	-	-	-	-	■ ¹	■ ¹	-	-	-	-	-
CONVIO FLEX 1230	■	■	■	■	■	■	■	■ ¹	■ ¹	■ ¹	-	-	-	-
CONVIO FLEX 1080	■	■	■	■	■	■	■	■	■	■	■	-	-	-
CONVIO FLEX 930	■	■	■	■	■	■	■	■	■	■	■	-	-	-
CONVIO FLEX 770	■	■	■	■	■	■	■	■	■	■	■	■	■	■
CONVIO cutterbars														
CONVIO 1380	■	■	■	■	■	■	■	■ ¹	■ ¹	-	-	-	-	-
CONVIO 1230	■	■	■	■	■	■	■	■ ¹	■ ¹	■ ¹	-	-	-	-
CONVIO 1080	■	■	■	■	■	■	■	■	■	■	■	-	-	-
CONVIO 930	■	■	■	■	■	■	■	■	■	■	■	-	-	-
CONVIO 770	■	■	■	■	■	■	■	■	■	■	■	■	■	■
Folding cutterbars														
C 540	-	-	-	■	■	■	■	■	■	■	■	■	■	■
C 450	-	-	-	-	-	-	-	■	■	■	■	■	■	■

■ Recommended □ Not recommended - Not available

¹ TERRA TRAC only

Front attachment	TRION 700				TRION 600			TRION 500		TUCANO 300	AVERO		DOMINATOR
	750	730	720	710	660	650	640	530	520	320	240	160	130
CERIO cutterbars													
CERIO 930	■	■	■	■	■	■	□	-	-	-	-	-	-
CERIO 770	■	■	■	■	■	■	■	□	□	□	-	-	-
CERIO 680	■	■	■	■	■	■	■	■	■	■	□	□	-
CERIO 620	-	■	■	■	■	■	■	■	■	■	□	□	-
CERIO 560	-	■	■	■	■	■	■	■	■	■	■	■	-
Standard cutterbars													
C 490	□	□	□	□	□	□	■	■	■	■	■	■	-
C 450	-	-	-	-	-	-	-	-	-	-	-	-	■
C 430	□	□	□	□	□	□	■	■	■	■	■	■	-
C 420	-	-	-	-	-	-	-	-	-	-	-	-	■
C 370	□	□	□	□	□	□	□	□	□	□	■	■	-
VARIO cutterbars													
VARIO 1380	-	-	-	-	-	-	-	-	-	-	-	-	-
VARIO 1230	■	-	-	-	-	-	-	-	-	-	-	-	-
VARIO 1080	■	■	-	-	-	-	-	-	-	-	-	-	-
VARIO 930	■	■	■	■	■	■	□	-	-	-	-	-	-
VARIO 770	■	■	■	■	■	■	■	□	□	□	-	-	-
VARIO 680	■	■	■	■	■	■	■	■	■	■	-	-	-
VARIO 620	■	■	■	■	■	■	■	■	■	■	□	-	-
VARIO 560	■	■	■	■	■	■	■	■	■	■	■	■	-
VARIO 500	■	■	■	■	■	■	■	■	■	■	■	■	-
MAXFLEX cutterbars													
MAXFLEX 930	■	■	■	■	■	■	-	-	-	-	-	-	-
MAXFLEX 770	■	■	■	■	■	■	■	□	□	□	-	-	-
MAXFLEX 680	■	■	■	■	■	■	■	■	■	■	-	-	-
MAXFLEX 620	□	□	■	■	■	■	■	■	■	■	-	-	-
MAXFLEX 560	□	□	■	■	■	■	■	■	■	■	-	-	-
CONVIO FLEX cutterbars													
CONVIO FLEX 1380	-	-	-	-	-	-	-	-	-	-	-	-	-
CONVIO FLEX 1230	□	□	□	-	-	-	-	-	-	-	-	-	-
CONVIO FLEX 1080	■	■	□	-	-	-	-	-	-	-	-	-	-
CONVIO FLEX 930	■	■	■	□	□	□	-	-	-	-	-	-	-
CONVIO FLEX 770	■	■	■	■	■	■	■	■	■	■	-	-	-
CONVIO cutterbars													
CONVIO 1380	-	-	-	-	-	-	-	-	-	-	-	-	-
CONVIO 1230	□	□	□	-	-	-	-	-	-	-	-	-	-
CONVIO 1080	■	■	□	-	-	-	-	-	-	-	-	-	-
CONVIO 930	■	■	■	-	□	□	-	-	-	-	-	-	-
CONVIO 770	■	■	■	■	■	■	■	■	■	■	-	-	-
Folding cutterbars													
C 540	■	■	■	■	■	■	■	■	■	■	■	-	-
C 450	□	□	□	□	■	■	■	■	■	■	■	■	-

Please note that these recommendations are not valid for all regions. The regional road traffic regulations must be observed. The front attachment matrix may vary as a result of differing climatic conditions or cultivation methods. The availability of individual combine harvester models depends on the applicable emissions standard for the country concerned and can therefore vary subject to national regulation.

Front attachment matrix - pickers.

Front attachment	LEXION 8000			LEXION 7000				LEXION 6000				LEXION 5000		
	8900	8800	8700	7700	7600	7500	7400	6900	6800	6700	6600	5500	5400	5300
CORIO 12-row														
CORIO 1275 C CONSPEED	■	■	■	■	■	■	■	■	■	■ ¹	–	–	–	–
CORIO 1270 C CONSPEED	■	■	■	■	■	■	■	■	■	■ ¹	–	–	–	–
CORIO 8-row unit														
CORIO 890 CONSPEED	■	■	■	■	■	■	■	■	■	■	■	■	■	■
CORIO 880 FC CONSPEED	■	■	■	■	■	■	■	■	■	■	■	■	–	–
CORIO 880 FC	■	■	■	■	■	■	■	■	■	■	■	■	–	–
CORIO 875 C CONSPEED	■	■	■	■	■	■	■	■	■	■	■	■	■	■
CORIO 875 FC CONSPEED	■	■	■	■	■	■	■	■	■	■	■	■	–	–
CORIO 875 C	■	■	■	■	■	■	■	■	■	■	■	■	■	■
CORIO 875 FC	■	■	■	■	■	■	■	■	■	■	■	■	–	–
CORIO 870 C CONSPEED	■	■	■	■	■	■	■	■	■	■	■	■	■	■
CORIO 870 FC CONSPEED	■	■	■	■	■	■	■	■	■	■	■	■	–	–
CORIO 870 C	■	■	■	■	■	■	■	■	■	■	■	■	■	■
CORIO 870 FC	■	■	■	■	■	■	■	■	■	■	■	■	■	■
CORIO 6-row unit														
CORIO 690 CONSPEED	–	–	–	–	–	–	–	■	■	■	■	■	■	■
CORIO 680 FC CONSPEED	–	–	–	–	–	–	–	■	■	■	■	■	■	■
CORIO 680 FC	–	–	–	–	–	–	–	■	■	■	■	■	■	■
CORIO 675 C CONSPEED	–	–	–	–	–	–	–	■	■	■	■	■	■	■
CORIO 675 FC CONSPEED	–	–	–	–	–	–	–	■	■	■	■	■	■	■
CORIO 675 C	–	–	–	–	–	–	–	■	■	■	■	■	■	■
CORIO 675 FC	–	–	–	–	–	–	–	■	■	■	■	■	■	■
CORIO 670 C CONSPEED	–	–	–	–	–	–	–	■	■	■	■	■	■	■
CORIO 670 FC CONSPEED	–	–	–	–	–	–	–	■	■	■	■	■	■	■
CORIO 670 C	–	–	–	–	–	–	–	■	■	■	■	■	■	■
CORIO 670 FC	–	–	–	–	–	–	–	■	■	■	■	■	■	■
CORIO 5-row unit														
CORIO 575 C	–	–	–	–	–	–	–	–	–	–	–	–	–	–
CORIO 570 C	–	–	–	–	–	–	–	–	–	–	–	–	–	–
CORIO 4-row unit														
CORIO 475 C	–	–	–	–	–	–	–	–	–	–	–	–	–	–
CORIO 470 C	–	–	–	–	–	–	–	–	–	–	–	–	–	–
CORIO 475 C (DOMINATOR only)	–	–	–	–	–	–	–	–	–	–	–	–	–	■
CORIO 470 C (DOMINATOR only)	–	–	–	–	–	–	–	–	–	–	–	–	–	■
SWATH UP														
SWATH UP 450	■	■	■	■	■	■	■	■	■	■	■	■	■	■
SUNSPPEED														
SUNSPPEED 16-70	■	■	■	■	■	■	■	■	■	■	■	–	–	–
SUNSPPEED 12-75	■	■	■	■	■	■	■	■	■	■	■	■	■	■
SUNSPPEED 12-70	■	■	■	■	■	■	■	■	■	■	■	■	■	■
SUNSPPEED 8-75	–	–	–	–	–	–	–	–	–	–	–	–	–	–
SUNSPPEED 8-70	–	–	–	–	–	–	–	–	–	–	–	–	–	–

■ Recommended □ Not recommended – Not available

¹ TERRA TRAC only

Front attachment	TRION 700				TRION 600			TRION 500		TUCANO 300	AVERO		DOMINATOR
	750	730	720	710	660	650	640	530	520	320	240	160	130
CORIO 12-row													
CORIO 1275 C CONSPEED	■	□	□	–	–	–	–	–	–	–	–	–	–
CORIO 1270 C CONSPEED	■	□	□	–	–	–	–	–	–	–	–	–	–
CORIO 8-row unit													
CORIO 890 CONSPEED	■	■	■	■	■	■	■	–	–	–	–	–	–
CORIO 880 FC CONSPEED	■	■	■	–	■	■	■	–	–	–	–	–	–
CORIO 880 FC	■	■	■	–	■	■	■	–	–	–	–	–	–
CORIO 875 C CONSPEED	■	■	■	■	■	■	■	–	–	–	–	–	–
CORIO 875 FC CONSPEED	■	■	■	–	■	■	■	–	–	–	–	–	–
CORIO 875 C	■	■	■	■	■	■	■	–	–	–	–	–	–
CORIO 875 FC	■	■	■	–	■	■	■	–	–	–	–	–	–
CORIO 870 C CONSPEED	■	■	■	■	■	■	■	–	–	–	–	–	–
CORIO 870 FC CONSPEED	■	■	■	–	■	■	■	–	–	–	–	–	–
CORIO 870 C	■	■	■	■	■	■	■	–	–	–	–	–	–
CORIO 870 FC	■	■	■	–	■	■	■	–	–	–	–	–	–
CORIO 6-row unit													
CORIO 690 CONSPEED	■	■	■	■	■	■	■	■	■	■	–	–	–
CORIO 680 FC CONSPEED	■	■	■	■	■	■	■	■	■	■	–	–	–
CORIO 680 FC	■	■	■	■	■	■	■	■	■	■	–	–	–
CORIO 675 C CONSPEED	■	■	■	■	■	■	■	■	■	■	–	–	–
CORIO 675 FC CONSPEED	■	■	■	■	■	■	■	■	■	■	–	–	–
CORIO 675 C	■	■	■	■	■	■	■	■	■	■	–	–	–
CORIO 675 FC	■	■	■	■	■	■	■	■	■	■	–	–	–
CORIO 670 C CONSPEED	■	■	■	■	■	■	■	■	■	■	–	–	–
CORIO 670 FC CONSPEED	■	■	■	■	■	■	■	■	■	■	–	–	–
CORIO 670 C	■	■	■	■	■	■	■	■	■	■	–	–	–
CORIO 670 FC	■	■	■	■	–	–	–	–	■	■	–	–	–
CORIO 5-row unit													
CORIO 575 C	□	□	□	□	■	■	■	■	■	■	■	■	–
CORIO 570 C	□	□	□	□	■	■	■	■	■	■	■	■	–
CORIO 4-row unit													
CORIO 475 C	–	–	–	–	–	–	–	–	–	–	–	■	■
CORIO 470 C	–	–	–	–	–	–	–	–	–	–	–	■	■
CORIO 475 C (DOMINATOR only)	–	–	–	–	–	–	–	–	–	–	–	–	■
CORIO 470 C (DOMINATOR only)	–	–	–	–	–	–	–	–	–	–	–	–	■
SWATH UP													
SWATH UP 450	■	■	■	■	■	■	■	■	■	■	–	–	–
SUNSPPEED													
SUNSPPEED 16-70	■	■	■	–	–	–	–	–	–	–	–	–	–
SUNSPPEED 12-75	■	■	■	■	■	■	■	■	■	–	–	–	–
SUNSPPEED 12-70	■	■	■	■	■	■	■	■	■	–	–	–	–
SUNSPPEED 8-75	■	■	■	■	■	■	■	■	■	■	■	■	–
SUNSPPEED 8-70	■	■	■	■	■	■	■	■	■	■	■	■	–

Please note that these recommendations are not valid for all regions. The regional road traffic regulations must be observed. The front attachment matrix may vary as a result of differing climatic conditions or cultivation methods.

The availability of individual combine harvester models depends on the applicable emissions standard for the country concerned and can therefore vary subject to national regulation.

Advantages at a glance.



Standard cutterbars.

- Proven rigid cutterbar table
- For DOMINATOR and AVERO

CERIO.

- Cutterbar table has an overall manual adjustment range of 200 mm
- Simple alternative to VARIO cutterbar
- Suitable for rice

VARIO.

- Cutterbar table is unique in having an infinitely variable overall adjustment range of 700 mm
- 10% more throughput thanks to adjustable table position
- Plug & Play for rapeseed.
- Cutterbar table with integrated rapeseed plates
- Suitable for rice

MAXFLEX.

- Optimal adaptation to ground contours for crops close to the ground
- 180 mm flexible knife bar, can be set to rigid configuration hydraulically for soybeans and grain

CONVIO FLEX / CONVIO.

- Optimal crop flow as a result of AUTOMATIC BELT SPEED
- Genuine multicrop capability for harvesting grains, rapeseed, soybeans, grass seed, etc.
- CONVIO FLEX with 225 mm flex range
- Extremely flat approach angle for minimal crop losses

Folding cutterbars.

- No additional trailer necessary
- Transport width of 3.0 m
- Full AUTO CONTOUR capability

CORIO CONSPEED / CORIO.

- Various picking concepts with CORIO CONSPEED and CORIO
- Large working widths from 12 to 4-row units
- Row widths of 90, 80, 75 and 70 cm
- Sunflower kits available

SUNSPEED.

- Harvests flower heads exclusively - stalk-free picking concept
- Large working widths from 16 to 8-row units

SWATH UP.

- Optimal swath pick-up characteristics
- Universal front attachment for different crop types
- Extremely efficient swath pick-up

Equipment.

- Automated reel control and VARIO automation
- Automatic front attachment guidance by CONTOUR, AUTO CONTOUR and MULTI CONTOUR
- Automatic adjustment
- Automatic steering systems
- Automatic parking and transport mode
- Automatic operating position

Front attachments	CONVIO FLEX / CONVIO cutterbars					VARIO cutterbars					CERIO cutterbars					Standard cutterbars					Folding cutterbars						
	1380	1230	1080	930	770	1380	1230	1080	930	770	680	620	560	500	930	770	680	620	560	C 490	C 450 ¹	C 430	C 420 ¹	C 370	C 540	C 450	
Effective cutting width	mm	13868	12344	10820	9296	7772	13790	12270	10740	9220	7696	6781	6172	5562	4920	7696	6781	6172	5562	4920	4550	4320	4240	3710	5460	4550	
Effective cutting width	ft.	45.50	40.50	35.50	30.50	25.50	45.25	40.25	35.25	30.25	25.25	22.25	20.25	18.25	16.25	30.25	25.25	22.25	20.25	18.25	16.14	14.93	14.17	13.91	12.17	14.93	
Drive on both sides		●	●	●	○	○	●	●	●	●	●	●	●	●	●	●	●	●	●	●	●	●	●	●	●	●	
Drive on one side		—	—	—	○	○	—	—	●	●	●	●	●	●	●	●	●	●	●	●	●	●	●	●	—	—	
Grain crop divider, folding		○	○	○	○	○	●	●	●	●	●	●	●	●	●	●	●	●	●	●	●	●	●	●	●	●	
Crop dividers adjustable for height without tools		●	●	●	●	●	●	●	●	●	●	●	●	●	●	●	●	●	●	●	●	●	●	●	●	●	
Soybean crop divider		○	○	○	○	○	—	—	—	—	—	—	—	—	—	—	—	—	—	—	—	—	—	—	—	—	
Spacing of knife bar to intake auger (min. / max)	mm	—	—	—	—	—	493/1134	493/1134	493/1134	493/1134	493/1134	493/1134	493/1134	493/1134	579	579	579	579	579	545	560	560	580	545	560	560	
Knife undivided		—	—	—	○	○	●	●	●	●	●	●	●	●	●	●	●	●	●	●	●	●	●	●	●	●	
MULTIFINGER intake auger		●	●	●	●	●	●	●	●	●	●	●	●	●	●	●	●	●	●	●	—	●	—	●	●	●	
Reel and auger bearing divided		●	●	●	—	—	●	●	●	—	—	—	—	—	—	—	—	—	—	—	—	—	—	●	●		
Reel and auger bearing undivided		—	—	—	●	●	—	—	●	●	●	●	●	●	●	●	●	●	●	●	●	●	●	●	●	●	
Crop lifters		●	●	●	●	●	●	●	●	●	●	●	●	●	●	●	●	●	●	●	●	●	●	●	●	●	
Vertical flexibility of knife bar	mm	225/-	225/-	225/-	225/-	225/-	—	—	—	—	—	—	—	—	—	—	—	—	—	—	—	—	—	—	—	—	
ACTIVE FLOAT		●/-	●/-	●/-	●/-	●/-	—	—	—	—	—	—	—	—	—	—	—	—	—	—	—	—	—	—	—	—	
Intake auger diameter (ext. / int.)		660/420	660/420	660/420	660/420	660/420	660/420	660/420	660/420	660/420	660/420	660/420	660/420	660/420	660/420	660/420	660/420	660/420	660/420	580/380	580/380	580/380	580/380	580/380	580/380	580/380	
Replacement knife		●	●	●	●	●	●	●	●	●	●	●	●	●	●	●	●	●	●	●	●	●	●	●	●	●	●
possible adjustment range, hydraulic	mm	—	—	—	—	—	700	700	700	700	700	700	700	700	—	—	—	—	—	—	—	—	—	—	—	—	
possible adjustment range, manual	mm	—	—	—	—	—	—	—	—	—	—	—	—	—	200	200	200	200	200	—	—	—	—	—	—	—	
Side belt depth	mm	1079.5	1079.5	1079.5	1079.5	1079.5	—	—	—	—	—	—	—	—	—	—	—	—	—	—	—	—	—	—	—	—	
Trough depth	mm	1329	1329	1329	1329	1329	—	—	—	—	—	—	—	—	—	—	—	—	—	—	—	—	—	—	—	—	
Centre belt width	mm	2000	2000	2000	2000	2000	—	—	—	—	—	—	—	—	—	—	—	—	—	—	—	—	—	—	—	—	
Weight (without rapeseed equipment)	kg	4600/4550	4350/4300	4050/4000	3510/3425	3000/2935	4679	4395	4112	2989	2557	2334	2224	2093	1941	2824	2419	2140	2040	1926	1300	1080	1120	1000	940	2100	1980

Automated cutterbar control

CONTOUR	—	—	—	—	—	—	—	—	○	○	○	○	○	○	○	○	○	○	○	○	○	○	○	○	○	○	○
AUTO CONTOUR	●	●	●	●	●	○	○	○	○	○	○	○	○	○	○	○	○	○	○	○	○	○	○	○	○	○	○
AUTO FLEX	●/-	●/-	●/-	●/-	●/-	—	—	—	—	—	—	—	—	—	—	—	—	—	—	—	—	—	—	—	—	—	
Automatic parking position	●	●	●	●	●	●	●	●	●	●	●	●	●	●	●	●	●	●	●	●	●	●	●	●	●	●	●
Automatic operating position	●	●	●	●	●	●	●	●	●	●	●	●	●	●	●	●	●	●	●	●	●	●	●	●	●	●	●
Reel draft control	●	●	●	●	●	●	●	●	—	—	—	—	—	—	—	—	—	—	—	—	—	—	—	—	—	—	
Reel speed control	●	●	●	●	●	●	●	●	●	●	●	●	●	●	●	●	●	●	●	●	●	●	●	●	●	●	●
Automatic reel height	●	●	●	●	●	●	●	●	●	●	●	●	●	●	●	●	●	●	●	●	●	●	●	●	●	●	●
Automatic reel levelling	●	●	●	●	●	●	●	●	●	●	●	●	●	●	—	—	—	—	—	—	—	—	—	—	—	—	
Automatic table control	—	—	—	—	—	●	●	●	●	●	●	●	●	●	—	—	—	—	—	—	—	—	—	—	—	—	
AUTOMATIC BELT SPEED	○	○	○	○	○	—	—	—	—	—	—	—	—	—	—	—	—	—	—	—	—	—	—	—	—	—	
LASER PILOT	○	○	○	○	○	○	○	○	○	○	○	○	○	○	○	○	○	○	○	○	○	○	○	○	○	○	

Rice equipment

Intake auger wear protection	—	—	—	—	—	—	—	—	○	○	○	○	○	○	○	○	○	○	○	○	○	○	○	○	○	○	○
Rice harvesting system	—	—	—	—	—	—	—	—	○	○	○	○	○	○	○	○	○	○	○	○	○	○	○	○	○	○	○
Dual knife system	—	—	—	—	—	—	—	—	—	—	—	—	—	—	—	—	—	—	—	○	—	○	—	—	—	—	

Rapeseed equipment

Rapeseed knives	○	○	○	○	○	○	○	○	○	○	○	○	○	○	—	—	—	—	—	—	—	—	—	—	—	—	—
Rapeseed plates	—	—	—	—	—	●	●	●	●	●	●	●	●	●	—	—	—	—	—	—	—	—	—	—	—	—	—
Spacing: knife bar – intake auger	mm	—	—	—	—	—	1134	1134	1134	1134	1134	1134	1134	1134	—	—	—	—	—	—	—	—	—	—	—	—	
possible adjustment range with rapeseed equipment	mm	—	—	—	—	—	700	700	700	150	150	150	150	150	—	—	—	—	—	—	—	—	—	—	—	—	
Feed auger	○	○	○	○	○	—	—	—	—	—	—	—	—	—	—	—	—	—	—	—	—	—	—	—	—	—	
Raised rear wall	●	●	●	●	●	—	—	—	—	—	—	—	—	—	—	—	—	—	—	—	—	—	—	—	—	—	

¹ DOMINATOR only

Front attachments	MAXFLEX cutterbars					
	930	770	680	620	560	
Effective cutting width	mm	9220	7696	6781	6172	5563
Effective cutting width	ft.	30.25	25.25	22.25	20.25	18.25
Drive on both sides		—	—	—	—	—
Drive on one side		●	●	●	●	●
Vertical flexibility of knife bar	mm	180	180	180	180	180
Knife divided		—	—	—	—	—
Knife undivided		●	●	●	●	●
MULTIFINGER intake auger		●	●	●	●	●
Reel and auger bearing divided		—	—			

Front attachments	CORIO CONSPEED 12-row		CORIO CONSPEED 8-row						CORIO CONSPEED 6-row						CORIO 8-row					CORIO 6-row				CORIO 5-row		CORIO 4-row						
	1275 C	1270 C	890	880 FC	875 C	875 FC	870 C	870 FC	690	680 FC	675 C	675 FC	670 C	670 FC	880 FC	875 C	875 FC	870 C	870 FC	680 FC	675 C	675 FC	670 C	670 FC	575 C	570 C	475 C	470 C	475 C ¹	470 C ¹		
Number of rows	12	12	8	8	8	8	8	8	6	6	6	6	6	6	8	8	8	8	8	6	6	6	6	6	5	5	4	4	4	4		
Row width	cm	75	70	90	80	75	75	70	70	90	80	75	75	70	70	80	75	75	70	70	80	75	75	70	70	75	70	75	70	75	70	
Transport position – rigid		●	●	●	–	●	–	●	–	●	–	●	–	●	–	●	–	●	–	–	●	–	●	–	●	●	●	●	●	●	●	
Transport position – folding		–	–	–	●	–	●	–	●	–	●	–	●	–	●	–	●	–	●	●	–	●	–	●	–	–	–	–	–	–	–	
Horizontal chopper		●	●	●	●	●	●	●	●	●	●	●	●	●	●	●	●	●	●	●	●	●	●	●	●	●	●	●	●	●	●	
Working width	m	9.78	8.63	7.17	6.53	6.18	6.18	5.83	5.83	5.37	4.93	4.68	4.68	4.43	4.43	6.53	6.18	6.18	5.83	5.83	4.93	4.68	4.68	4.43	4.43	3.93	3.73	3.18	3.03	3.18	3.03	
Transport width	m	9.78	8.63	7.17	3.35	6.18	3.00	5.83	3.00	5.37	3.35	4.68	3.00	4.43	3.00	3.35	6.18	3.00	5.83	3.00	3.35	4.68	3.00	4.43	3.00	3.93	3.73	3.18	3.03	3.18	3.03	
Stubble breaker		●	●	●	●	●	●	●	●	●	●	●	●	●	●	●	●	●	●	●	●	●	●	●	●	●	●	●	●	●	●	●
MONTANA mounting kit		○	○	○	○	○	○	○	○	○	○	○	○	○	○	○	○	○	○	○	○	○	○	○	○	○	○	○	○	○	○	○
Sunflower kit		○	○	○	○	○	○	○	○	○	○	○	○	○	○	○	○	○	○	○	○	○	○	○	○	○	○	○	○	○	○	○
Hood extensions		○	○	○	○	○	○	○	○	○	○	○	○	○	○	○	○	○	○	○	○	○	○	○	○	○	○	○	○	○	○	○
Lodged maize augers		○	○	○	○	○	○	○	○	○	○	○	○	○	○	○	○	○	○	○	○	○	○	○	○	○	○	○	○	○	○	○
Shear bar kit		●	●	●	●	●	●	●	●	●	●	●	●	●	●	●	●	●	●	●	●	●	●	●	●	●	●	●	●	●	●	●
Sprocket for intake auger speed increase		○	○	○	○	○	○	○	○	○	○	○	○	○	○	○	○	○	○	○	○	○	○	○	○	○	○	○	○	○	○	○
Electrohydraulic snapping plate adjustment		●	●	●	●	●	●	●	●	●	●	●	●	●	●	●	●	●	●	●	●	●	●	●	●	●	●	●	●	●	●	●
Intake auger loss protection		●	●	●	●	●	●	●	●	●	●	●	●	●	○	○	○	○	○	○	○	○	○	○	○	○	○	○	○	○	○	○
Road transport protection incl. lighting and safety bar		–	–	–	●	–	●	–	●	–	●	–	●	–	●	–	●	–	●	●	–	●	–	●	–	–	–	–	–	–	–	
Support for trailer		○	○	○	–	○	–	○	–	○	–	○	–	○	–	–	○	–	○	–	–	○	–	○	–	○	○	○	○	○	○	
Weight	kg	3820	3700	3750	2990	2590	2910	2510	2855	2150	2355	2030	2295	2030	2295	3110	270	3030	2630	2950	2445	2120	2385	2120	2385	1770	1770	1475	1475	1460	1460	
Automated cutterbar control																																
AUTO CONTOUR		○	○	○	○	○	○	○	○	○	○	○	○	○	○	○	○	○	○	○	○	○	○	○	○	○	○	○	○	○	○	
AUTO PILOT		○	○	○	○	○	○	○	○	○	○	○	○	○	○	○	○	○	○	○	○	○	○	○	○	○	○	○	○	○	○	

¹ For DOMINATOR 130 only



CLAAS KGaA mbH
Mühlenwinkel 1
33428 Harsewinkel
Deutschland
Tel. +49 5247 12-0
claas.com