



Round balers

ROLLANT



The world of CLAAS.

You need to reap the rewards for all that hard work. And to get the job done, day after day out in the fields, down the long straights, turning in the headland or working on steep slopes, you also need some support along the way – preferably from a partner you know you can trust.

Tackling the task, and seeing it through to the end: that's your approach, and it's also what drives us – because as well as being an outstanding round baler, the CLAAS ROLLANT is the player you need on your team. It offers you ease of operation, high productivity, and above all, total reliability. In short, a great partnership, for a great result.



ROLLANT from CLAAS	2
History	4
Overview	6
Pick-up	8
Feed systems	10
ROTO CUT Heavy Duty	12
Bale chamber	14
MAXIMUM PRESSURE SYSTEM	16
Wrapping	18
Heavy Duty drive system	20
Technology in detail	22
The UNIWRAP design concept	24
ROLLANT 620 / 520	26
ROLLANT 540	28
Operation	30
CEMIS 700	32
Maintenance	36
CLAAS Service & Parts	38
Specifications	40

An all-round success: 100,000 ROLLANT.



The ROLLANT fixed chamber baler was developed in 1976.

CLAAS introduced the ROLLANT, the first round baler, in 1976, and our factory in Metz, France, has produced 100,000 ROLLANT balers since.

The ROLLANT is renowned, tried and tested all over the world. Whether straw, hay, silage, maize or cotton: the ROLLANT bales whatever our customers need.

But development never stops, not even after more than 45 years of experience. Read on to find out how our engineers have improved the ROLLANT's quality and reliability even further.

The ROLLANT success story.

- 1976: Market launch as the first baler with steel rollers in the bale chamber
- 1983: Introduction of the ROLLATEX net wrapping system
- 1991: ROTO CUT cutting system
- 1998: MAXIMUM PRESSURE SYSTEM with pivoting 3-roller segment
- 2001: Baling and wrapping in a single step – the UNIWRAP design
- 2010: The ROLLANT 400 series for throughputs of up to 51 t
- 2020: The 100,000th ROLLANT rolls off the assembly line

An effective combination: over 20 years of UNIWRAP.



ROTO CUT: 4-star cutting quality.

The first ROTO CUT cutting rotor was integrated in 1991. Only from CLAAS: The 4-star rotor enables more cuts per minute and therefore increases the cutting quality. The ROTO CUT cutting rotor was already available in the first ROLLANT 255 UNIWRAP.

Up to 25 knives...
... are located in the ROLLANT knife bank, depending on the model, for a high-quality cut.

Since 2000: progress through experience.

- Large tyres and a single axle for optimal ground contour following
- Number of knives increased from 14 to 25
- From 7,056 to 13,800: more cuts per minute for higher-quality forage
- The knives and cutting frame can always be operated from the cab
- Rollers twice as thick as those in the first ROLLANT UNIWRAP models
- Bale transfer and wrapping cycle reduced from 50 to 35 seconds
- Wrapping time for 6 layers per bale accelerated from 35 to 23 seconds
- Now with net and net replacement film wrapping

A wide product range to meet any requirements.

ROLLANT ø 1.50 m – the seasoned expert.



Solo balers.

ROLLANT 620.

- ROTO FEED or ROTO CUT
- 7 knives
- Forced intake thanks to the rotor
- Net wrapping or twine tying
- Up to 150 bar baling pressure
- Pick-up with crop guard
- Pick-up with single or double roller crop press

ROLLANT ø 1.25–1,35 m – the machine that does it all.



ROLLANT 520.

- ROTO FEED or ROTO CUT
- 14 knives
- Hydraulic ROTO REVERSE
- Net wrapping or twine tying
- Up to 150 bar baling pressure
- Pick-up with baffle plate or roller crop press
- Optional: MPS II

ROLLANT 540.

- ROTO CUT Heavy Duty
- 15 knives
- Automatically lowering PRO cutting frame
- Film or net wrapping or twine tying
- Up to 180 bar baling pressure
- Automatic tailgate (COMFORT)
- Pick-up with roller crop press
- Optional: MPS II

UNIWRAP ø 1.25–1.35 m – everything for wrapping.



Baler/wrapper combination.



UNIWRAP ROLLANT 455.

- ROTO CUT Heavy Duty
- 25 knives
- Automatically lowering PRO cutting frame
- Net and/or film wrapping
- Up to 180 bar baling pressure
- Automatic tailgate (COMFORT)
- Pick-up with roller crop press
- MPS PLUS
- High-performance wrapper

UNIWRAP ROLLANT 454.

- ROTO CUT Heavy Duty
- 25 knives
- Automatically lowering PRO cutting frame
- Net and/or film wrapping
- Up to 180 bar baling pressure
- Automatic tailgate (COMFORT)
- Pick-up with single or double roller crop press
- High-performance wrapper



ROLLANT 454 / 455.

- ROTO CUT Heavy Duty
- 25 knives
- Automatically lowering PRO cutting frame
- Net wrapping
- Up to 180 bar baling pressure
- Comfort hydraulics
- Pick-up with single or double roller crop press
- MPS PLUS standard in the ROLLANT 455

Ensures a great start:
the pick-up.

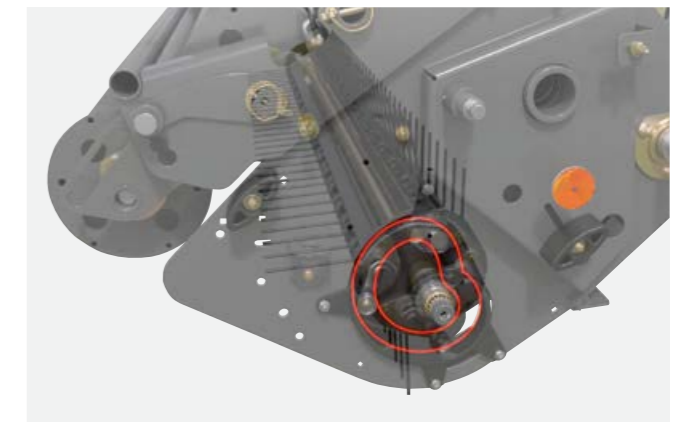

Single or double roller crop press –
for higher performance.

What benefits does a forward-mounted roller crop press offer? In short, it presses the crop down, speeds up the crop flow and actively conveys it to the rotor. It also ensures that the bale chamber is filled evenly, thus creating perfectly round bales. Having the pick-up close to the rotor ensures optimum crop transfer. This combination of conveyor augers and roller crop press makes your work easier, particularly when working in uneven silage swaths.

2.10-m working width –
for total work performance.

The pick-up of the ROLLANT 520 has a working width of 2.10 m and picks up even very wide swaths. A speed of 140 rpm ensures an even crop flow without forage soiling. The short baffle plate guides the crop flow reliably to the rotor even when baling small or irregular swaths. The pick-up is equipped with flexible spring steel tines that have proven their worth even under the hardest of conditions. The tines are closely spaced to leave a cleanly raked field.

Another benefit is that the operator can monitor the crop flow straight from the cab, as the pick-up is positioned clearly visible at the front. This makes it easier for you to adjust speeds to swath sizes and enables you to control the crop flow optimally to prevent baler blockages.

Cam-controlled pick-up for optimum crop flow.

The cam-controlled pick-up adjusts to any ground contours, even at high working speeds and while negotiating curves. Proven technology from other CLAAS products (JAGUAR, CARGOS, QUADRANT).

Generously dimensioned lateral stub augers,
for tightly packed bale edges.

To prepare the way, generously dimensioned lateral stub augers adjust the crop to the bale chamber width. This keeps the bales particularly firm around the edges and makes them extremely robust. The benefit: The bales will withstand rough handling during transport and storage without losing their shape.

At a glance.

- With a working width of 2.10 m, the pick-up easily captures even very wide swaths.
- The ingenious pick-up design and location reduce forage losses and contamination.
- The crop flow remains consistent even in curves and at high speeds.
- Roller crop presses and a baffle plate increase the throughput even further.

Feeder systems:
the right system for each application.



Maximum crop flow output: ROTO FEED.

The rotor blades of the feed rotor are arranged in dynamic helices to ensure uniform intake and efficient throughput. The system is particularly well-suited to delicate types of forage such as alfalfa. The helical arrangement protects crops and produces top-quality forage.

For high-quality milk: ROTO CUT.

Energy-rich, palatable silage with optimum lactic acid fermentation is a fundamental prerequisite for high milk production in the dairy herd. This requires three things: short fodder, high compaction and the exclusion of oxygen.

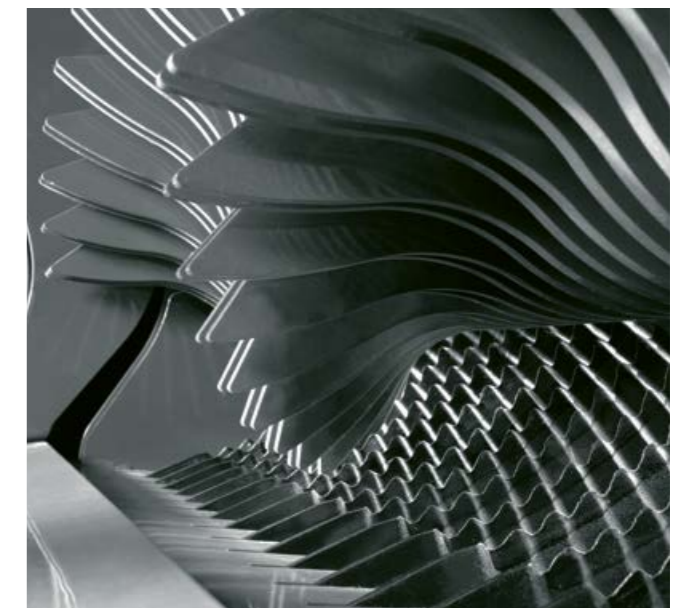

Regarding the cutting quality, the solid heavy-duty cutting rotor in the ROLLANT is designed for ultimate performance. It is made of double-hardened boron steel with helical double tines. Individual blade protection prevents damage to the knives, increases their service life and ensures consistent cutting quality. The knives are also available with tungsten carbide coating.

Unique:
the tried and tested ROTO CUT concept.



ROTO CUT – short cut.

The ROTO CUT feed system runs at up to 13,800 cuts per minute. Four rows of tines gather in the crop evenly through the knives. The crop is guided exactly over the centre of the blades and cut with precision in the process. A special system of strippers keeps the rotor clean throughout operation. The carefully fine-tuned angle to the feed tines effectively prevents crushing of the crop as it passes through. Uniformly cut slices improve silage quality and facilitate easy distribution both in silage preparation and later on in the feed mixer.

Operational reliability.

The 14, 15 or 25 knives of the knife bar are individually secured. They are spring preloaded and therefore able to avoid foreign objects. Knives not affected by such objects continue to cut the crop cleanly and reliably for optimal forage quality.

Knives removed in a flash.

When the bale chamber is opened, the knives can be easily installed and removed from above.

**When endurance matters:
ROTO CUT Heavy Duty.**

Tough job to be done? Bring it on! The Heavy Duty drive concept in the ROLLANT makes these machines ideal for tough working conditions in silage. This is because of the 8-mm-thick, four-star dual tines, the ultra-robust individual blade protection and very robust knife bracket. Cutting quality therefore remains excellent even in silage.

What makes ROTO CUT HD so effective:

- ROTO CUT 8-mm tine stars
- Reinforced individual blade protection
- Reinforced Tsubaki chains (main drive and rotor drive)
- Standard or HD knives
- 44 mm or 70 mm length of cut

ROLLANT PRO.

Baling is hard work, and speed is of the essence. That means high daily throughput rates and intelligent systems to help the driver get the job done. These include a floor-lowering function for active adaptation to the crop flow. Automatic lowering by up to 30 mm allows the continuous intake even of irregular swaths, with no impact on cutting quality.

Early warning system helps avoid blockages.

Any unusual floor movement is detected by a sensor and immediately displayed on the control terminal as an optical and acoustic alert. This enables you to respond promptly to any risk of blockage from the comfort of the cab. As a result you can operate the baler right up to its limits without unwanted downtimes from blockages.

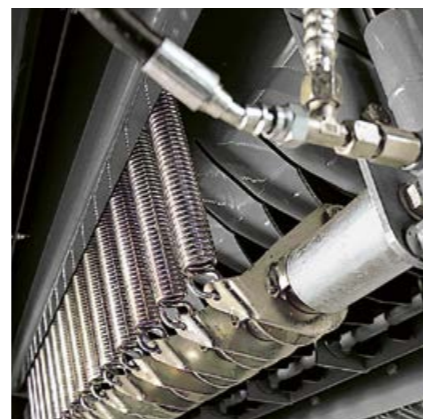

High pressure with particularly robust steel rollers.



Discover the new ROLLANT roller concept.



At a glance.

- Up to 4 mm wall thickness
- Flanged design
- Ribbed profile for perfect bale rotation even in wet harvesting conditions
- Continuous, laser-welded baling roller walls for increased stability of the baling roller
- Forged roller stubs to withstand extreme loads
- Variable bale diameter from 1.25 to 1.35 m



High pressure with particularly robust steel rollers.

For quality forage, crops need to be compacted quickly into high-density bales. In the ROLLANT, this is done with highly robust steel rollers with profile webs, which ensure an active crop feed. Thanks to the web profile, the crop is pressed into firm, round bales with excellent shape retention even in damp conditions. All bearings and drive shafts are designed for this baler's high power and throughput.



Hydraulic pressure control.

The locking mechanism via a hydraulic ram enables the tailgate to adjust to and lightly resonate in line with the rising pressure as the bale size increases. The bale is able to rotate at all times, and the baling process is neither slowed down nor inhibited in any way.

Opening and closing in record time.

The double-acting hydraulic rams are highly responsive to ensure that you are able to open and close the tailgate extremely speedily from the tractor cab.

A top performer excels when under pressure.



MAXIMUM PRESSURE SYSTEM II for ROLLANT 520 and ROLLANT 540.

- 3-roller segment with two large, adjustable springs
- Excellent value for money for denser bales
- Softer or harder bales as needed
- Perfect bale shape even in difficult conditions

Hydraulic MAXIMUM PRESSURE PLUS for the ROLLANT 455 and ROLLANT 455 UNIWRAP.

- Pressure adjustment via the CEMIS 700 (60–120 bar)
- Bale fill level indicator
- Optimal bale density
- Thanks to the bale fill level indicator, the last 5 and 10 cm of the bale can remain uncut, as the knives can swing out automatically.

MAXIMUM PRESSURE SYSTEM – MPS.

The steel roller bale chamber with MPS is your guarantee of rock-hard bales with high core compaction. That's because of the extra pressure delivered by MPS, the pivoting three-roller segment in the ROLLANT tailgate. At the start of the baling process, the three MPS rollers project into the bale chamber. During the process, the rollers are then pushed up into their end position by the bale as it increases in size.

The benefits for you: The bale rotates right from the start and is compacted already from a diameter of 90 cm. With the pressure freely adjustable from 60 to 120 bar, the end result is perfectly compacted, high-density bales – even at high ground speeds.

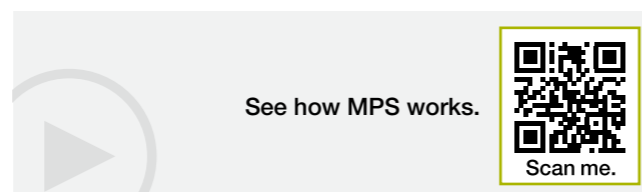

Tailgate pressure: 180 bar

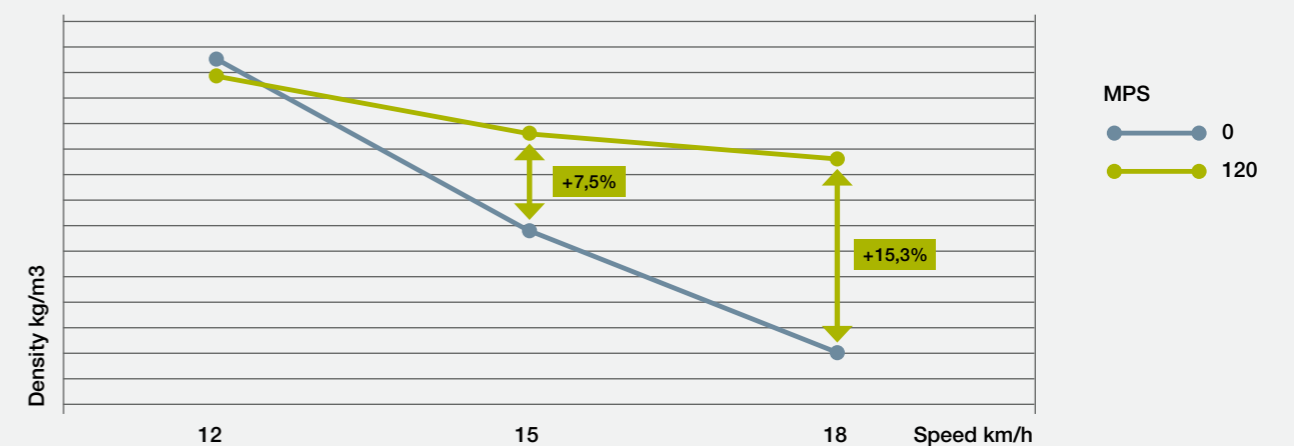

Same density with or without MPS at 12 km/h. With MPS at 120 bar, the R455 UNIWRAP retains density levels even at high speeds. Up to 15.3% greater density with 120 bar in the MPS compared to bales pressed without MPS.

Net, twine or film – it's your choice.



Film wrapping.

With the ROLLANT 455 UNIWRAP and ROLLANT 454 UNIWRAP, you can choose to wrap your bales with film rather than net. The pre-stretched film fits particularly tightly around the bale. This means less consumption of material, better sealing of bales and optimum preservation of forage to ensure optimal forage quality.



Wrapping and tying always in view.

Whichever type of wrapping or tying you choose, you always have a clear view of the process. In all ROLLANT models, the wrapping/tying system is directly visible even while driving to make sure you're always on top of the status and progress of the process.



In great shape with the new net wrapping.

Whether twine or net, you'll be sure to get everything right with the ROLLANT models. The new net wrapping system works more reliably than ever and saves a lot of time: wrapping is fully automatic and takes only a few seconds. The sophisticated net guide allows the net to be applied tightly across the full bale width and firmly binds the edges as well. The result is firmly wrapped bales with a good bale shape.



Your alternative: twine tying.

With twine tying, you have a choice of manual or automatic twine start. The automatic system starts the process once the set final pressure is reached, with the operator receiving a visual and acoustic alert.



Does even more: the COMFORT version.

The ROLLANT COMFORT allows you to control the number of wraps from the ISOBUS control unit in the tractor cab. As a result, you can respond flexibly to your customers' requirements. The automatic tailgate opening and closing feature is unique to this machine. This additional comfort feature is offered by all ROLLANT 454/455 models (including UNIWRAP) and the ROLLANT 540 COMFORT.



Roll changes are a breeze.

If you wrap your bales with net or film, you need to handle heavy rolls. However, changing rolls is a breeze thanks to the convenient loading bay on any ROLLANT machine.

Key requirements for harvesting – perfectly coordinated resources.



How much Heavy Duty you need is your decision.

The key success factors for bale silage are high compression, reliable operation, outstanding cutting quality and a user-friendly machine. The extensive CLAAS range of balers has the right machine for every farmer or contractor, from the ROLLANT 520 entry-level model to the 455 UNIWRAP for any baling task – and of course much more besides.



CLAAS Heavy Duty: making light of hard work.

Balers in the ROLLANT range come equipped with the Heavy Duty drive line, meaning that the main transmission, drive chains and cutting system, including knives and knife guards, are designed for the toughest conditions and heaviest loads.

The 400 series models have a very high main transmission torque. This means even greater power, which is critical for difficult crop materials such as moist or wet silage. Heavy Duty means precisely what it says: the rotor is made of solid 8-mm boron steel, double-hardened. There are four rows of tines for optimum feed intake. Yet the power requirement is relatively low, thanks to the helically arranged dual tines. A sturdy frame provides all-round protection.

The rollers are even stronger than before, with a large stub axle. Eight bracing elements welded to the roller sleeve ensure maximum strength.

All Heavy Duty components deliver high reliability and a long service life, no matter what operational demands you put on your new ROLLANT. This is clearly reflected in the large chain dimensions:

- Heavy Duty rotor chains
- Heavy Duty main drive chain
- Heavy Duty tailgate chain

At a glance.

- Heavy Duty chopping system (knife and knife guard)
- Heavy Duty main transmission, running at 1,000 rpm
- Heavy Duty rotor
- Tsubaki Heavy Duty drive chains

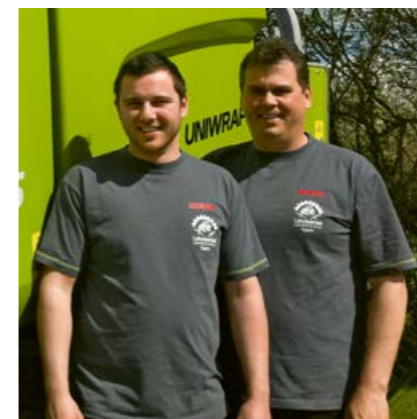
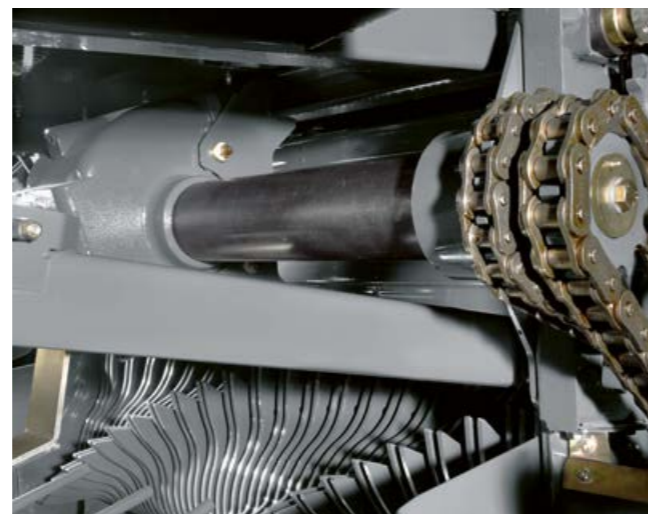

“This is one tough baler – the whole chassis, including the wrapper, and all the chains and rollers have been built extra-strong, and the chopping performance is superb!”

Gunnar/Max Kortum, of Kortum contractors, on the Heavy Duty drive concept

Our top performer: the ROLLANT 455 UNIWRAP.

The ROLLANT product family is a powerful team – all of them with sophisticated technology. And each of them a pro in its field. After all, each field and each harvest are unique.

Whether in hay, straw, silage or hemp – all models stand out through superior performance above all. The ROLLANT 455 UNIWRAP is the top performer in our team, and we'd like to introduce this baler to you in more detail.

- 16-roller fixed-chamber design for perfectly formed silage bales and optimum crop flow
- Up to 25 knives for highest-quality cuts
- 23-second wrapping cycle with six layers of film
- 2.10-m pick-up for a huge intake capacity
- Net and/or film wrapping
- Hydraulic MAXIMUM PRESSURE SYSTEM (MPS)

At a glance.

- The fastest wrapper on the market
- Superior reliability with new, stronger rollers
- Unrivalled bale density
- Outstanding user convenience
- 25 knives, for excellent silage quality



- | | | |
|--|---|---|
| <ul style="list-style-type: none"> 1 2.10-m pick-up 2 ROLLANT PRO with lowerable floor 3 Steel-roller rolling chamber with hydraulic MPS PLUS compaction system 4 ISOBUS control with COMMUNICATOR II 5 Large-sized, long-life chains | <ul style="list-style-type: none"> 6 HD baling rollers 7 Wrapping process accelerated by over 30% – just 23 seconds for six layers of film 8 12 seconds for bale transfer (from opening to closing the tailgate) 9 High-speed wrapping-arm drive up to 36 rpm | <ul style="list-style-type: none"> 10 67% or 82% pre-stretching for airtight bale wrapping and reduced film consumption 11 Large-sized tyres, 550/60-22.5 or 620/55 R 26.5 optional 12 Film wrapping |
|--|---|---|



Learn all about the ROLLANT UNIWRAP.

Scan me.

A clever design: the UNIWRAP concept.



Discover the advantages
of film wrapping.

Scan me.



At a glance.

- Saving valuable time: the fastest transfer platform and fastest wrapper on the market
- The process can be controlled from the terminal: via the CEMIS 700 in the cab or, uniquely, via the CLAAS MEDIUM TERMINAL II directly on the wrapper



Wrapping at its best.

The UNIWRAP with two 750-mm pre-stretchers wraps six layers of film with 52% overlap tightly around the bale. In no time at all, or more precisely in a mere 23 seconds.

As a result, the wrapper is always faster than the baler, so that the ROLLANT can be operated at full capacity even with the addition of the wrapper. The film is pre-stretched by 67% as standard, and by 82% as an option – a tension which ensures that it is tightly attached all around the bale. Using the 82% pre-stretching option lowers your film consumption, makes the film supply go further and reduces your handling costs.

If either of the two rolls of film runs out before the wrapping cycle is complete, the unfinished bale is carefully wrapped at half speed using the other film roll. Each of the two wrapping arms is equipped with a sensor to monitor correct operation – the driver is alerted to the situation, and the wrapping speed is also automatically reduced.

The entire wrapping process can be controlled from the terminal, with a choice of the ISOBUS terminal in the tractor cab or the CLAAS MEDIUM TERMINAL (CMT) directly on the wrapper.

Transferring the load.

The compact design of the UNIWRAP baler/wrapper combination allows for the rapid and reliable transfer of the bale. Bale transfer takes a mere 12 seconds from the moment the tailgate opens until it closes again. Laterally mounted plates centre the bale accurately, even on sloping terrain. The transfer platform then raises the bale safely onto the wrapping



table, which is tilted towards the bale chamber, where the bale is guided along by an array of large rollers.

What happens during maintenance work, such as a film change, for example? No problem. You can simply operate the wrapping functions and film shears manually, directly at the wrapper, with the CLAAS MEDIUM TERMINAL II. The wrapper control terminal can also be used to set the number of film layers and mode of operation – either "bale and wrap" or "bale without wrapping".

Twisting the bale.

The bale twisters place the film-wrapped bales on their left front face during discharge. This is to minimise damage from hard stubble, because the top and bottom faces generally have the thickest film cover. For transport, the bale twister is simply raised hydraulically. As a result, the overall length of the UNIWRAP does not change when on the road.



CLAAS introduces the next chapter of the ROLLANT's successful 45-year track record with a new generation of machines. The ROLLANT 520 fixed-chamber baler combines all the benefits of the popular predecessor models ROLLANT 340 and 350. This new baler is very easy to operate, highly versatile and extremely robust.



- 1 2.10-m pick-up
- 2 Feed system optionally with ROTO CUT, ROTO FEED with feed rotor
- 3 Optional net wrapping system
- 4 Optional twine tying system
- 5 Kinematics with reinforced rollers
- 6 Simple bale pressure adjustment
- 7 More space for net rolls or twine reels
- 8 Easy-to-use loading ramp for net rolls
- 9 Chain lubrication as standard
- 10 Control via the CEMIS 700

Modern design.



The proven ROLLANT fixed-chamber concept is subject to continuous development and improvement by our engineers. For the new generation, they have revised the design completely. One glance at the new lines makes it clear that this is one of the most robust balers in the world.

Smooth crop flow.



The controlled pick-up adjusts to any ground contours, even at high working speeds and while negotiating curves. Large guide wheels with tool-free adjustment keep you safely on track at all times.

Easy unloading.



Blockages in the intake can be cleared quickly and easily by reversing the rotor mechanically using the rotor lever. The optionally available hydraulic rotor unblocking unit can be activated from the cab and allows the baler to be driven right up to its performance limits without any problems.

The fixed-chamber design concept of the ROLLANT 620.



The 17 HD rollers, with a significantly thicker casing, process the crop into firm 1.22 x 1.50-m bales with excellent shape retention – with net wrapping or twine tying as desired.

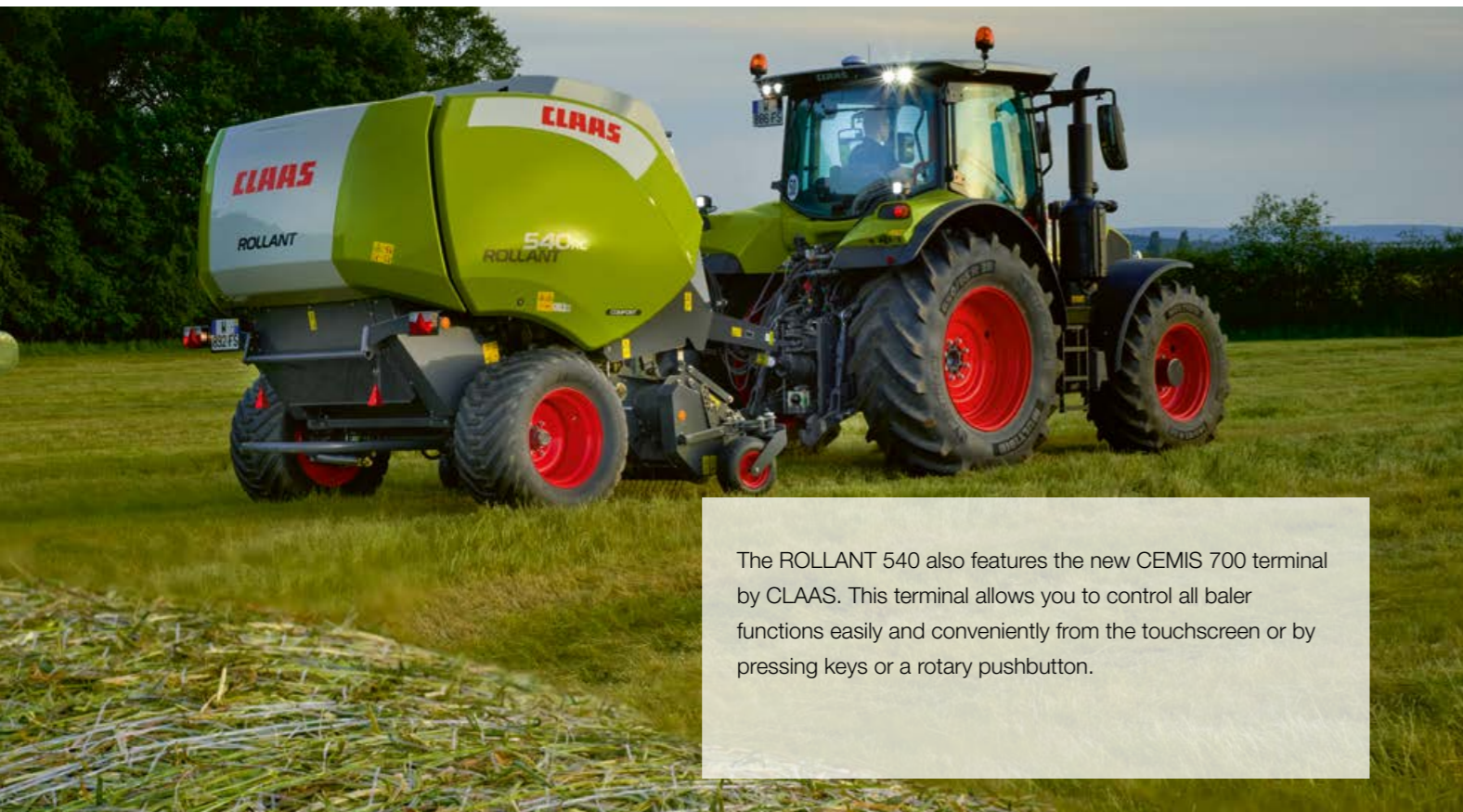

The ROLLANT 540 also features the new CEMIS 700 terminal by CLAAS. This terminal allows you to control all baler functions easily and conveniently from the touchscreen or by pressing keys or a rotary pushbutton.



- 1 Bale dimensions of 1.22 x 1.25 m
- 2 Controlled 2.10-m pick-up
- 3 ROTO CUT: 15-knife cutting rotor
- 4 Hydraulic knife group activation (0, 7, 8, 15)
- 5 PRO: drop cutting frame for blockage clearance
- 6 Bale chamber with 15 reinforced rollers
- 7 MAXIMUM PRESSURE SYSTEM available as optional equipment
- 8 Shaft diameter for rollers: 50 mm
- 9 Double-row bearing for rollers 2, 3, 10, 15
- 10 1 1/4" rotor drive / 1 1/4" main drive
- 11 2-strand twine tying
- 12 Twine tying / net wrapping
- 13 Comfort net wrapping
- 14 Comfort net/film wrapping
- 15 CEMIS 700 with ISOBUS technology

Power-efficient drive concept.

Optimised drive concept.

The most powerful baling rollers on the market.

Even more user-friendly.

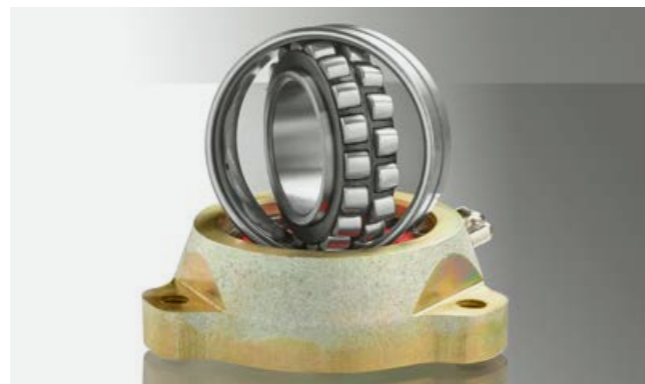

All drives are straight and mounted completely on the left-hand side. This allows the power to be transmitted with optimum efficiency. In the ROLLANT 540, only large long-life Tsubaki chains are used, which are lubricated with a constant oil film.

In addition to the rollers, the drive concept of the ROLLANT has been revised. The chains, sprockets and bearings, i.e. all components subject to extreme loads for several hours every working day, have been reinforced. With its larger sprockets and extremely strong cast roller bearing head, the ROLLANT 540 is also ready for heavy crop work.

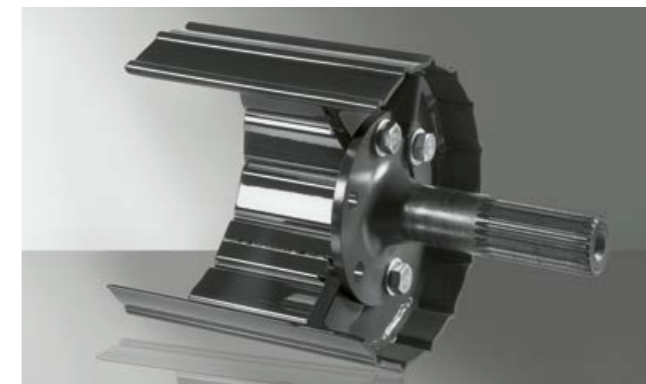

The CLAAS ROLLANT is the world's top-selling fixed chamber baler. Its proven, robust fixed-chamber concept is continually being enhanced by CLAAS engineers. The ROLLANT 540 features the latest generation of rollers with 15 reinforced rollers, 50-mm drive stubs and extra-robust ball bearings for perfectly formed silage bales and optimum crop flow.



The ROLLANT 540 opens and closes the tailgate automatically in just six seconds once the operator puts the tractor in neutral. The operator's workload is further reduced by the automatic knife cleaning cycle, automatic knife deactivation and convenient knife group activation from the cab.

What should hard work be like?
Easy as child's play.

Machine operation using the new CEMIS 700 terminal.

However much you enjoy your work, it shouldn't fill every hour of every day. So every day we do our best to ease your workload, with good ideas, robust equipment and innovative technology. User-friendly, convenient operation is always our number one focus.



CEMIS 700.

A new terminal for even greater comfort.

The CEMIS 700 incorporates three approaches to machine control: a touchscreen function, a rotary pushbutton and keys.

The touchscreen on the CEMIS 700 allows operators to select functions directly by simply tapping on the 7" touchscreen. If it is easier to simply press a key while working in the field, the CEMIS 700 also offers you this option.

Your advantages at a glance:

- New terminal with convenient user navigation and touchscreen
- 7" display with very high resolution
- Two camera inputs

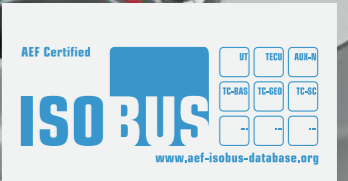

Touch-screen operation.

Ergonomic control terminal.

Job counter for 20 customers.

Two camera inputs.

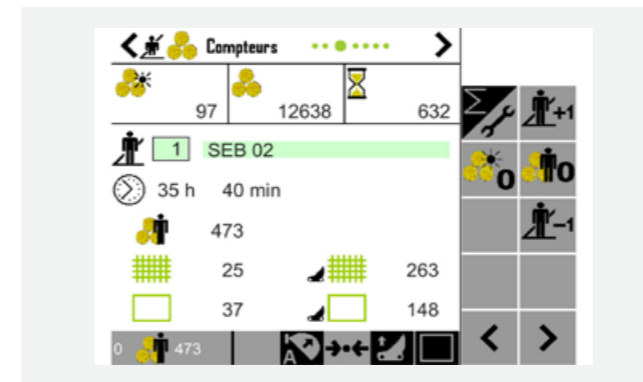

Use the touch function on the CEMIS 700 to select a function directly by simply pressing the 7" touchscreen.

- Simple control inputs make for easier use in the field
- Can also be operated via a rotary pushbutton and keys, in addition to the touch function
- The proven CLAAS control logic and symbols make this terminal easy to use

Determines important values for increased transparency for your customers:

- Total number of bales
- Number of bales per day
- Total number of chopped bales
- Working time at customer's site

- Connection for two cameras
- Greater convenience and better machine control
- Fewer screens in the tractor cab

Designed for day and night work.

Unique technology for compact bales.
ROLLANT by CLAAS.

A baler needs to do more than just bale hay and straw. Today's farms have a wide range of requirements in terms of bale size and shape and how the bales are going to be used. CLAAS meets these requirements with its ROLLANT. These fixed-chamber balers with robust drives and reinforced rollers are perfect for your daily work. They also feature a wide range of smart solutions to make them particularly easy to operate and maintain.





Constant chain lubrication.

The new distribution units in the 6.3-litre lubrication system supply each individual chain with exactly the amount of oil needed for long and smooth-running operation. You can save on cash, in addition to valuable maintenance time. The oil volume can be adjusted depending on operating conditions.

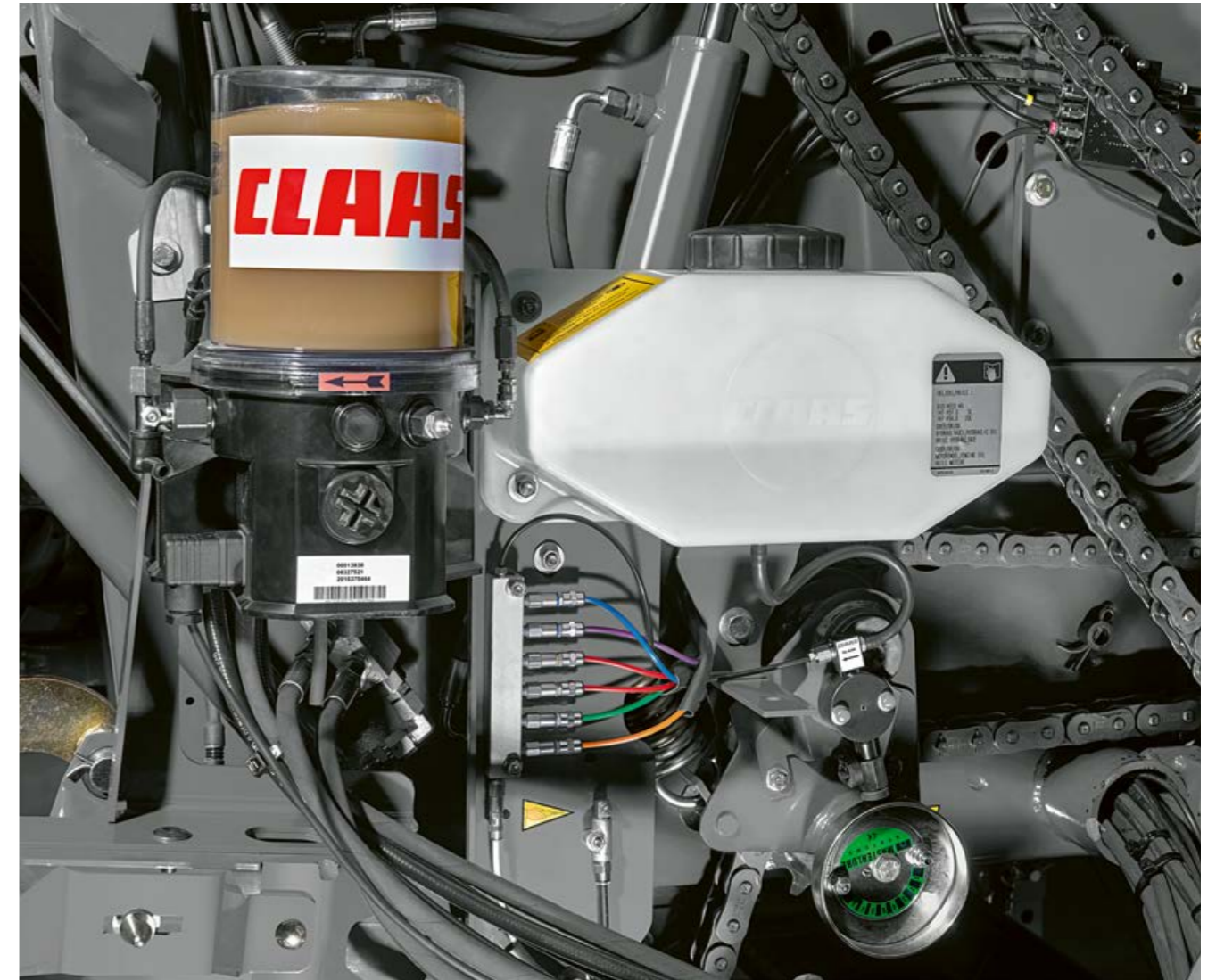

Electric central lubrication.

The lubrication intervals can be set directly on the terminal to ensure that the bearings are automatically lubricated as required.

Whatever it takes – CLAAS Service & Parts.



CLAAS Service & Parts is always there for you, 24/7. service.claas.com



Scan me.



Specially matched to your machine.

Precision-manufactured parts, high-quality consumables and useful accessories. Choose our comprehensive product range to be certain of receiving exactly the right solution to ensure 100% operational reliability for your machine.



For your business: CLAAS FARM PARTS.

CLAAS FARM PARTS offers one of the most comprehensive ranges of multi-brand parts and accessories for all agricultural applications on your farm.



Global supply.

The CLAAS Parts Logistics Center in Hamm, Germany, stocks almost 200,000 different parts and has a warehouse area of over 183,000 m². This central spare parts warehouse delivers all ORIGINAL parts quickly and reliably all over the world. This means that your local CLAAS partner can supply the right solution for your harvest or your business within a very short time.

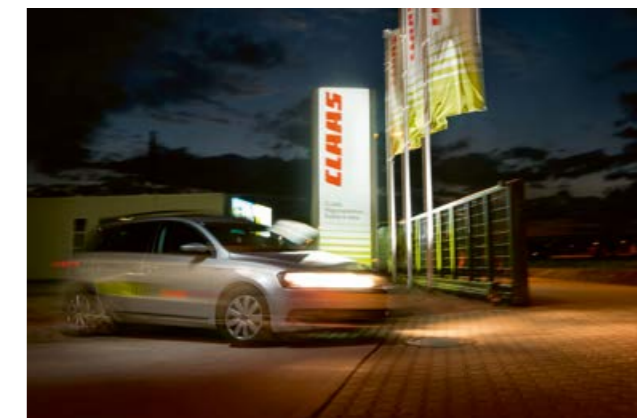

Your local CLAAS distributor.

Wherever you are, you can count on us to always provide you with the service and the contact persons you need. Your CLAAS partners are on hand in your local area, ready to support you and your machine around the clock. With know-how, experience, commitment and the best technical equipment. Whatever it takes.

ROLLANT		520 RC	520 RF	620 RC	620 RF
Attachment					
PTO shaft speed	rpm	540	540	540	540
Single wide-angle drive shaft with freewheel and cam clutch		●	○	●	○
Single wide-angle universal drive shaft with shear coupling		●	●	●	●
Pick-up					
Width	m	2.10	2.10	2.10	2.10
DIN pick-up width	m	1.90	1.90	1.90	1.90
Simple spool valve for raising the pick-up and the knives		●	–	●	–
Number of tines per row		32	32	32	32
Tine spacing	mm	70	70	70	70
Pick-up castor guide wheels		Fixed (oscillating ○)	Fixed (oscillating ○)	Fixed (oscillating ○)	Fixed (oscillating ○)
Crop feed					
Forced crop feed with		ROTO CUT	ROTO FEED	ROTO CUT	ROTO FEED
Number of knives		14	–	7	–
Hydraulic connection					
Simple spool valve for raising the pick-up		●	●	●	●
Double-acting spool valve for tailgate rams		●	●	●	●
Bale chamber					
Number of baling rollers		16	16	17	17
MAXIMUM PRESSURE SYSTEM II		○	○	–	–
Automatic dual twine wrapping		●	●	●	●
Net wrapping ROLLATEX		●	●	●	●
Number of twine reels in the twine box		6	6	6	6
Number of net rolls		2	2	2	2
Adjustable baling pressure on the machine		●	●	●	●
Bale ramp		○	○	○	○
Automatic chain lubrication		●	●	●	●
Bale chamber dimensions					
Width	m	1.20	1.20	1.22	1.22
Diameter	m	1.25	1.25	1.50	1.50
Operation					
ISOBUS cable		○	○	○	○
CEMIS 700		●	●	●	●
Tyres					
11.5/80-15.3 8PR		●	●	●	●
15.0/55-17 10PR		○	○	○	○
19.0/45-17 10PR		○	○	○	○
Running axle		●	●	●	●
Dimensions and weights					
Length	m	4.70	4.70	5.08	5.08
Width	m	2.50	2.50	2.47	2.47
Height	m	2.30	2.30	2.97	2.97
Weight	kg	2990	2685	3470	3250

ROLLANT		540 RC COMFORT	540 RC	540 RF
Attachment				
PTO shaft speed	rpm	540/1000	540/1000	540/1000
Wide-angle drive shaft with cam control		●	●	●
Pick-up				
Working width according to DIN 11220	m	2.10	2.10	2.10
Hydraulic pick-up lift		●	●	●
Ground adaptation via two height-adjustable guide wheels		●	●	●
Fixed guide wheels		–	●	●
Castor guide wheels		○	○	○
Folding castor guide wheels		○	○	○
Feeder system				
Rotor		ROTO CUT	ROTO CUT	ROTO FEED
Knife group activation		0, 7, 8, 15	0, 15	–
Hydraulic connection				
Single-acting spool valve for pick-up lift		●	●	●
Double-acting spool valve for tailgate rams		–	●	●
Single-acting spool valve with pressure-free return + LS		●	–	–
Bale chamber				
Number of baling rollers		15	15	15
MAXIMUM PRESSURE SYSTEM (MPS II)		○	○	○
ROLLATEX net wrapping		–	●	●
Twine/ROLLATEX net wrapping		–	○	○
ROLLATEX COMFORT net wrapping		●	–	–
Bale chamber dimensions	m	1.22 × 1.25	1.22 × 1.25	1.22 × 1.25
Control units				
ISOBUS cable		○	○	○
CEMIS 700		●	●	●

CLAAS continually develops its products to meet customer requirements. This means that all products are subject to change without notice. All descriptions and specifications in this brochure should be considered approximate and may include optional equipment that is not part of the standard specifications. This brochure is designed for worldwide use. Please refer to your nearest CLAAS distributor and their price list for local specification details. Some protective panels may have been removed for photographic purposes in order to present functions clearly. To avoid any risk of danger, never remove these protective panels yourself. In this respect, please refer to the relevant instructions in the operator's manual.

● Standard ○ Optional □ Available – Unavailable

ROLLANT		455 RC UNIWRAP	455 RC	454 RC UNIWRAP	454 RC
Attachment					
PTO shaft speed	rpm	1000	1000	1000	1000
Ball hitch		○	○	○	○
Drive chains		Heavy duty	Heavy duty	Heavy duty	Heavy duty
Hydraulic connection					
2 x single-acting spool valve and open return line		●	●	●	●
Pick-up					
Width	m	2.10	2.10	2.10	2.10
DIN raking width	m	1.90	1.90	1.90	1.90
Roller crop press		○	○	○	○
Oscillating pick-up castor guide wheels		●	●	●	●
Double roller crop press		○	○	○	○
Crop feed					
ROTO CUT Heavy Duty cutting rotor		●	●	●	●
Number of knives		25 (0, 12, 13, 25)	25 (0, 12, 13, 25)	25 (0, 12, 13, 25)	25 (0, 12, 13, 25)
HD knives		○	○	○	○
Blanked-off knives		○	○	○	○
Drop PRO cutting frame		●	●	●	●
Bale chamber					
Number of baling rollers		16	16	16	16
Automatic chain lubrication		●	●	●	●
Automatic central lubrication for baler bearings		○	○	○	○
Bale ejector		–	●	–	●
Bale chamber dimensions					
Width	m	1.20	1.20	1.20	1.20
Diameter	m	1.25–1.35	1.25–1.35	1.25–1.35	1.25–1.35
Operation					
ISOBUS cable		○	○	○	○
CEMIS 700		●	●	●	●
CLAAS MEDIUM TERMINAL II (wrapper)		●	–	●	–
Wrapping					
Net wrapping		●	●	●	●
Film wrapping		○	–	○	–
Wrapper					
Film stretcher	mm	2 × 750	–	2 × 750	–
Film capacity		14 rolls	–	14 rolls	–
Overlap, configurable	%	52	–	52	–
Pre-stretching	%	67 (82 ○)	–	67 (82 ○)	–
Slope equipment		○	–	○	–
Tyres					
15.0/55-17 10PR		–	●	–	●
19.0/45-17 10PR		–	○	–	○
550/60-22.5		–	–	–	–
560/45-22.5 16PR		–	○	–	○
620/55 R 26.5		●	–	●	–
Compressed-air brake system		●	○	●	○
Overall dimensions					
Length	m	6990	4250	6990	4250
Width	m	2955	2955	2955	2955
Height	m	3250	3250	3250	3250
Weight	kg	5800	3150	5800	3150
Options					
Work lights		○	○	○	○
Bale twister		○	○	○	○
Load sensing		●	●	●	●



CLAAS continually develops its products to meet customer requirements. This means that all products are subject to change without notice. All descriptions and specifications in this brochure should be considered approximate and may include optional equipment that is not part of the standard specifications. This brochure is designed for worldwide use. Please refer to your nearest CLAAS dealer and their price list for local specification details. Some protective panels may have been removed for photographic purposes in order to present functions clearly. To avoid any risk of danger, never remove these protective panels yourself. In this respect, please refer to the relevant instructions in the operator's manual.

● Standard ○ Optional □ Available – Unavailable



CLAAS UK
Saxham
Bury St. Edmunds
Suffolk
IP28 6QZ
Tel 01284 763100
claas.co.uk
info-uk@claas.com

365FarmNet enables you to manage your entire agricultural business by means of a single, non-proprietary software solution. Interfaces to intelligent applications created by partners in the agricultural sector offer expert support for your business 365 days a year.

CLAAS is a 365FarmNet partner.

www.365farmnet.com

