



Tractors

ARION

470 460 450 440 430 420 410



The new ARION 400.
Enjoy the freedom.

Every day brings new challenges. But you can look forward to them,
because your tractor's got everything covered.

The new ARION 400. Enjoy the freedom.



Ludovic Cousin, product specialist for CLAAS tractors.

Dear ARION fans. This freedom is really worth shouting about.

- Clever operator assistance systems make your job easier
- Intelligent data management simplifies your documentation
- Efficient connectivity improves your work processes
- A smart transmission takes all the effort out of shifting
- Exceptional cab comfort makes your days more productive



Digital assistant. TELEMATICS, ISOBUS and GPS PILOT to ease your workload.
Page 48



Small turning circle. With steering angle-dependent automatic four-wheel drive, you can manoeuvre with speed and agility.
Page 19



Increased lift capacity. With 6.5 t lift capacity at the rear, you can handle any implement.
Page 22

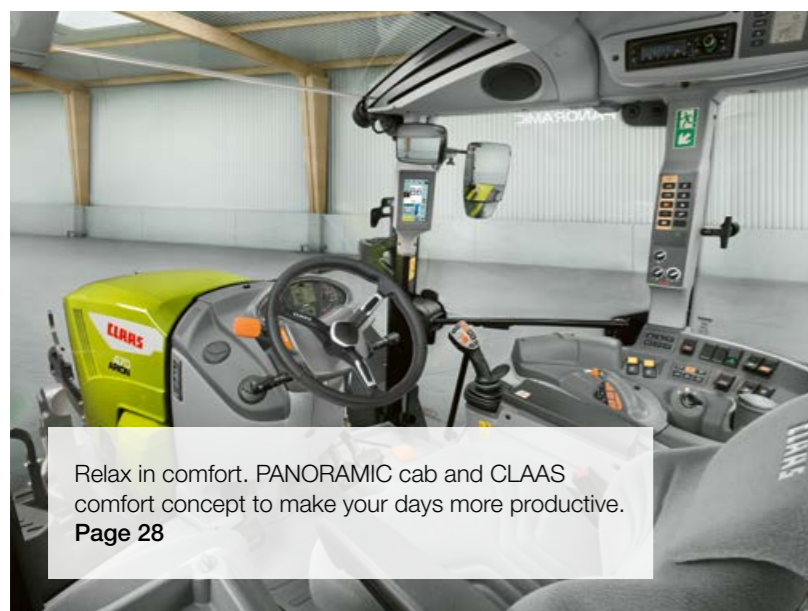

Relax in comfort. PANORAMIC cab and CLAAS comfort concept to make your days more productive.
Page 28



Powerful hydraulics. With an output of 150 l/min, you can work quickly and efficiently even when using large hydraulic consumers.
Page 20



Low power-to-weight ratio. 155 hp and a power-to-weight ratio of just 34 kg/hp make the ARION more versatile than ever.
Page 8

The ARION 400. Enjoy the freedom.	2
CLAAS POWER SYSTEMS	6
Engine	8
Transmission	10
Construction	16
Hydraulics	20
Rear linkage, PTO	22
Front linkage	24
Front loaders	26
Cab and comfort	28
Cab variants	30
Municipal work	32
Versions	36
Multifunction control lever and multipad	38
Right-hand control panel	40
CIS and CIS colour display	42
Comfort	44
Operator assistance systems and data management	48
CSM, dynamic steering	50
GPS PILOT CEMIS 1200	52
GPS PILOT CEMIS 1200, ISOBUS functions	54
Data management	56
Maintenance	58
CLAAS Service & Parts	60
Features	62
Technical data	63



Enjoy the freedom.
arion400.claas.com

Our drive system: the perfect interplay between optimal components.

Your CLAAS machine is much more than the sum of its individual parts. Top performance is only possible when all parts are ideally matched and work together optimally.

In CLAAS POWER SYSTEMS (CPS), we have brought together top-quality components to create an intelligent drive system that sets new standards. Full engine output only when you need it. Drives that are suited to the way your machines are used. Fuel-saving technology which quickly pays off.



Dear ARION fans.

My name is Guillaume Charlès and I am a part of the core project team working on the new ARION 400. I have been involved in the development of the new ARION right from the word go. I particularly like the intelligent transmission system. It selects the right gear to suit the speed and load – regardless of whether I am driving in manual or automatic mode.

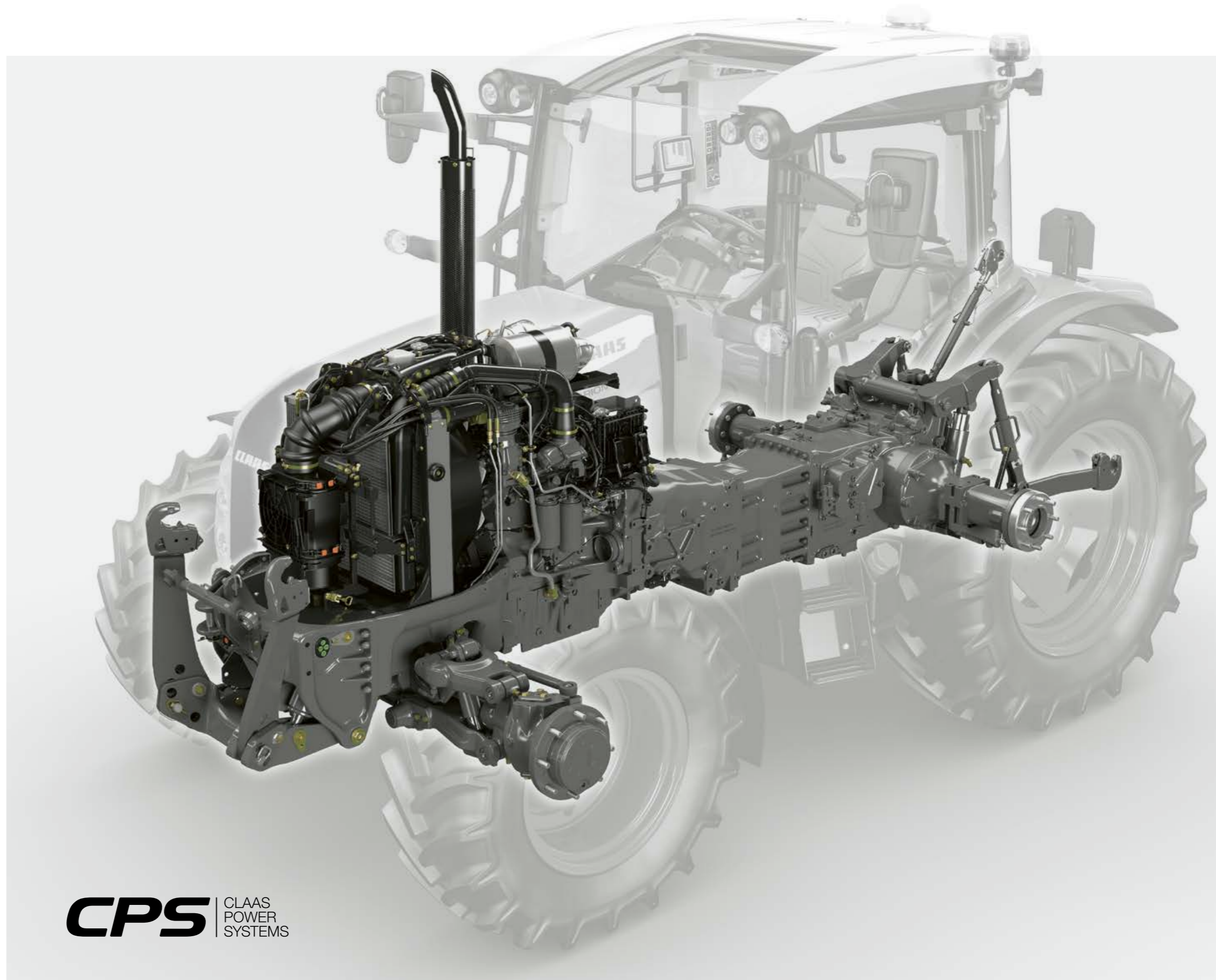

CPS | CLAAS
POWER
SYSTEMS

CLAAS POWER MANAGEMENT. Take it up a level.

Strong at heart.

Under the bonnet, all models feature FPT (Fiat Powertrain Technologies) engines with a cubic capacity of 4.5 l and all the latest technology.

- 4-valve technology
- 1,600 bar high-pressure common rail injection
- Turbocharger (ARION 420 / 410)
- Turbocharger with wastegate (ARION 470-430)
- Intercooler
- Complies with Stage V emissions standard thanks to Selective Catalytic Reduction on Filter (SCRoF) and DOC catalytic converters

Constant output.

Look forward to 8% more torque. The CLAAS-specific engine performance curve allows you to work with full torque in a wide engine speed range. As a result, the ARION guarantees constant output and delivers the power just when you need it. This means that you can save fuel while working at a low engine speed and maximum torque with the ECO PTO, or work at rated speed with a full reserve.

Precise engine speed.

Up to two electronic engine speed memories are available in addition to the traditional hand throttle on the right-hand console. The driver can set two precise engine speeds and activate them at the press of a button. Press the button again or press the accelerator pedal once to deactivate the engine speed memory. Practical and precise on the headland.

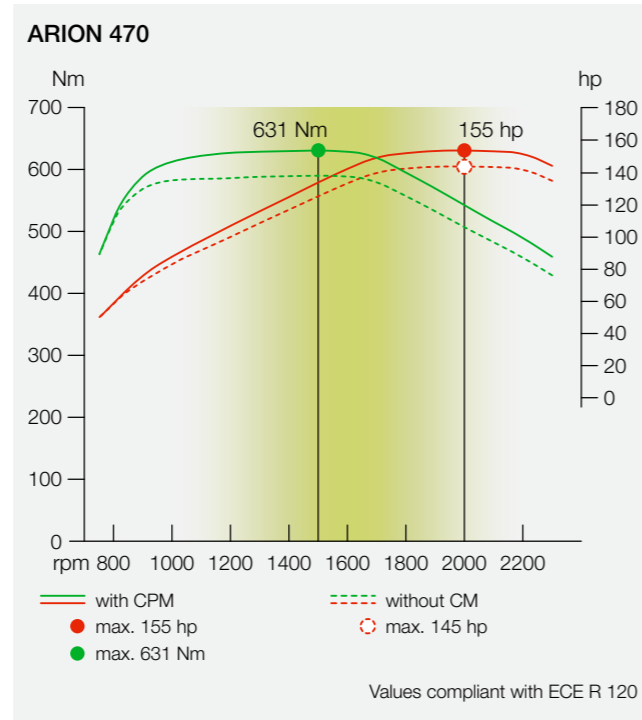

Low power-to-weight ratio thanks to CPM.

Power and ease of handling make the ARION more versatile than ever. The intelligent CLAAS POWER MANAGEMENT (CPM) electronic control system delivers an additional 10 hp in the 470-440 models, e.g. for PTO or transport work. This increases the maximum output to 155 hp. Combined with an unladen weight of just 5.3 t (ARION 470), this gives the tractor a power-to-weight ratio of only 34 kg/hp.

ARION	Maximum torque in Nm ¹	Maximum output in hp ¹	Maximum output with CPM in hp ¹
470	631	145	155
460	615	135	145
450	573	125	135
440	539	115	125
430	505	115	-
420	434	100	-
410	405	90	-

¹ ECE R 120



Stage V for clean exhaust emissions.

In the Stage V-compliant ARION 400, all components of the exhaust gas aftertreatment system have been cleverly incorporated to ensure that the engine compartment and maintenance points can still be accessed with ease. The diesel oxidation catalytic converter (DOC) is positioned under the bonnet immediately behind the turbocharger as it needs high exhaust gas temperatures to work effectively. The Selective Catalytic Reduction on Filter (SCRoF) is an integral part of the exhaust system and is located on the right-hand side of the tractor.



QUADRISHIFT and HEXASHIFT.

Using the clutch pedal is a thing of the past.

- 1 Creep gears
- 2 Four hydraulically controlled ranges
- 3 REVERSHIFT clutchless reverser
- 4 QUADRISHIFT module with four powershift speeds or HEXASHIFT module with six powershift speeds

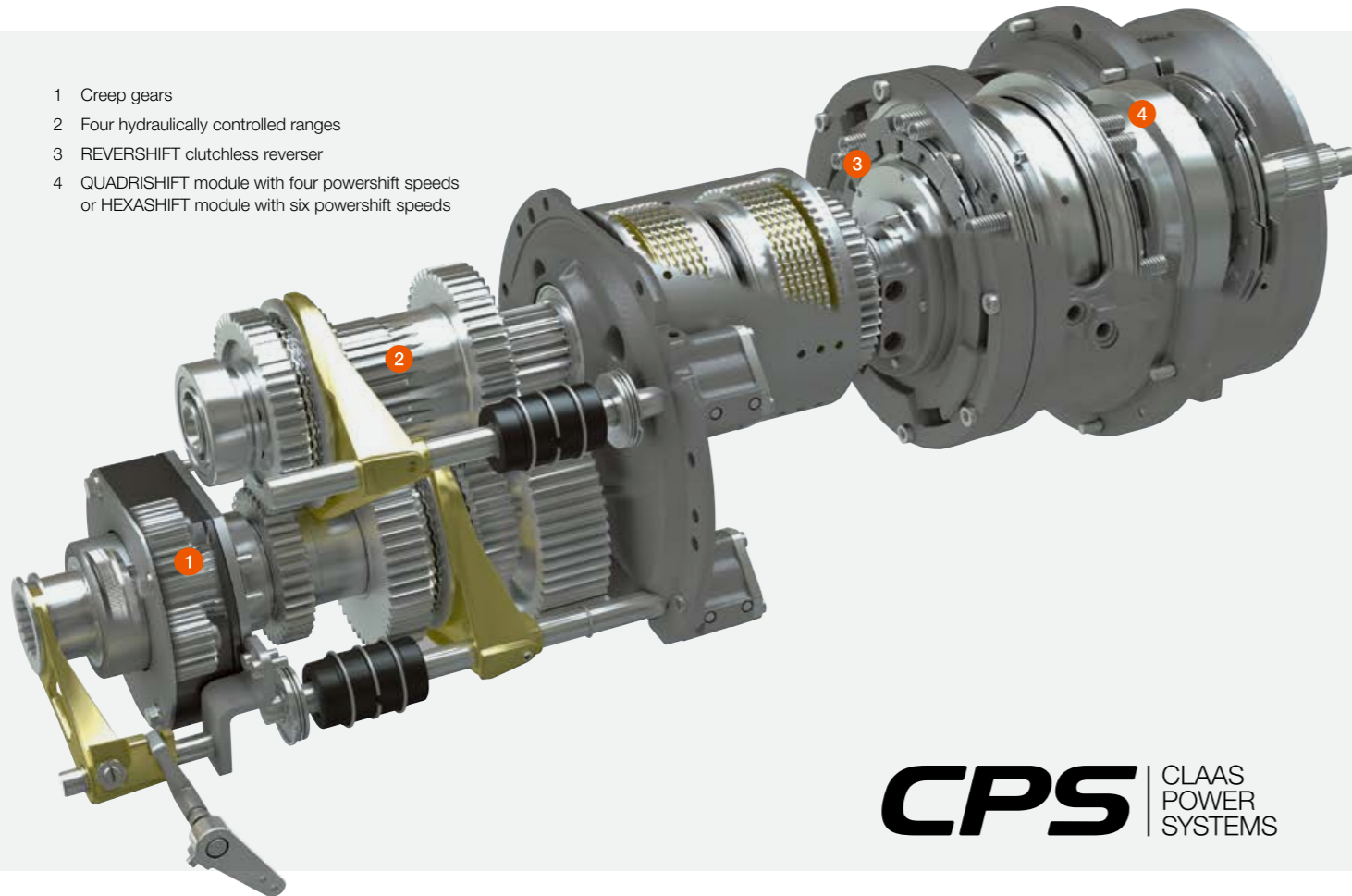

CPS | CLAAS
POWER
SYSTEMS

The transmission. Technology for demanding work.

The QUADRISHIFT or HEXASHIFT transmission enables you to change powershift speed without cutting the power flow and optimally match your forward speed to the conditions on the ground. On the road or around the farm, you can effortlessly select any one of four hydraulically shifted ranges without having to use the foot clutch. Overlapping powershift speeds allow you to utilise the full output potential of the engine and provide smooth range shifting on the road.

Ranges and powershift speeds are shifted manually using the rocker switch on the multifunction control lever or via the buttons on the right-hand console – making range shifting with the clutch and gear lever a thing of the past.

You can let the QUADRACTIV or HEXACTIV auto-shift function do the shifting for you, allowing you to work efficiently in a relaxed frame of mind. When it comes to control, efficiency and versatility, the ARION 400 is in a class of its own.

Automatic functions for more comfort.

SMART STOP

Bring the tractor to a standstill without using the clutch.

Cruise control

Set and retrieve two target speeds.

Auto-shift function

The transmission does the switching for you, whatever driving mode you are in.

QUADRISHIFT: 16 gears at the push of a button

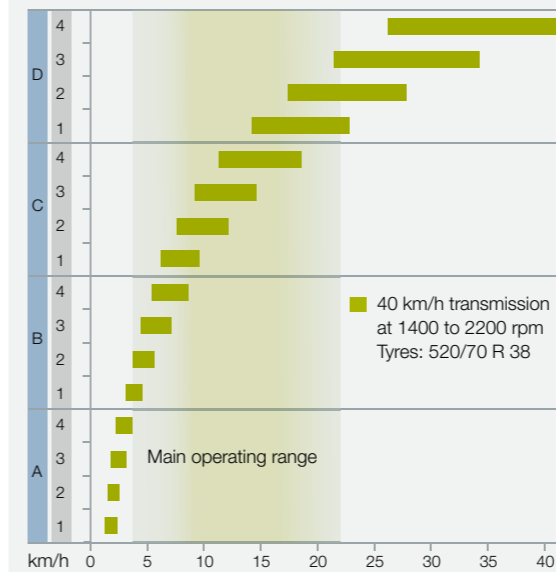

QUADRISHIFT

- 16 forward and reverse gears, all shifted without clutching
- Four powershift speeds and four hydraulically shifted ranges
- Fully automatic shifting with QUADRACTIV

HEXASHIFT: 24 gears at the push of a button

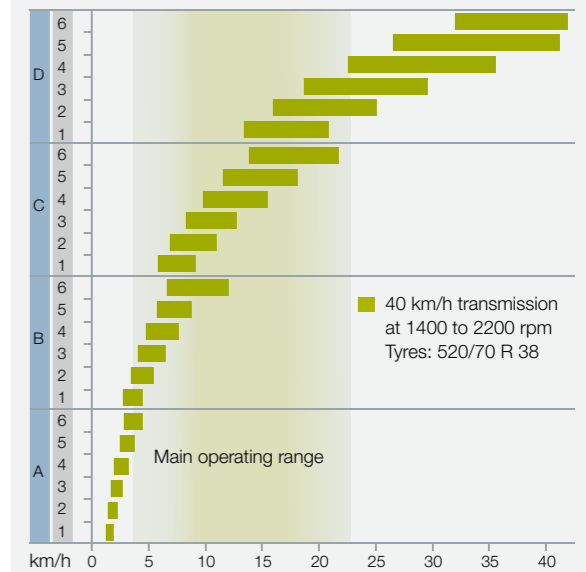

HEXASHIFT¹

- 24 forward and reverse gears, all shifted without clutching
- Six powershift speeds and four hydraulically shifted ranges
- Fully automatic shifting with HEXACTIV
- Max. top speed at reduced engine speed (1,840 rpm)

The benefits for you.

- Transmission operated without the gear lever or clutch pedal
- Multifunction control lever for maximum convenience
- CLAAS power train management for smooth gear shifting when changing range or powershift speed
- REVERSHIFT clutchless reverser for effortless direction changing
- Automatic speed matching
- Convenient configuration options for transmission management with the CIS (CLAAS INFORMATION SYSTEM)
- Excellent efficiency in the field and on the road for low fuel consumption
- Creep gear options down to 150 m/h

¹ Only available with the ARION 470, 460, 450, 440 and 430.

QUADRISHIFT and HEXASHIFT.

Almost like continuously variable shifting.



Automatic transmission control.

There's no need to move through every gear (as in a conventional powershift transmission) when shifting between ranges – the transmission automatically selects the most appropriate gear depending on forward speed and load, regardless of whether you are driving manually or automatically.

The current gear is indicated at all times on the instrument panel, and also in the A-pillar with CIS+ and CIS models.

If you press the clutch in range D, the transmission automatically adjusts the powershift speed when the clutch is re-engaged. This can be very useful, e.g. when approaching a road junction.

SMART STOP.

With the SMART STOP function, ARION 400 tractors can be brought to a standstill by pressing the brake, without needing to use the clutch pedal. This lightens the driver's workload considerably, especially during tasks which involve a lot of stopping and starting such as making round bales and front loader work. SMART STOP is easily activated in the CIS.

The current gear is indicated at all times on the instrument panel, and also in the A-pillar with CIS+ and CIS models.



More options with CIS (CLAAS INFORMATION SYSTEM).

Intelligent gear selection.

When using the clutchless reverser, you can even change gear automatically when you want the forward speed (1) to be different from the reverse speed (2) (e.g. for front loader work). At the headland, you can also engage a pre-selected gear (3) (headland gear) simply by pressing a button. In tractors with the CIS on-board information system, all transmission information is shown on the additional display in the right-hand A-pillar.

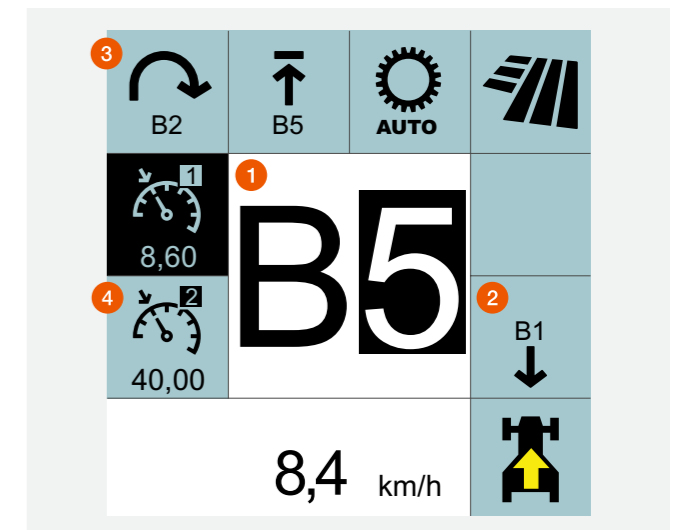

Cruise control and automatic shifting.

The start-up gear automatically engaged on starting the engine can be freely selected between A1 and D1. A separate approach gear can also be selected when operating with the auto-shift function activated. The HEXACTIV auto-shift function can also be equipped with a cruise control function (4). Instead of a fixed engine speed, at the press of a button a target forward speed can be set which the tractor maintains by adjusting the engine speed and gear ratio.



Progressive REVERSHIFT.

When changing direction, the tractor should respond differently depending on the load and the job in hand. Whether you want a smooth change of direction on the headland or a fast change of direction on the clamp – with CIS anything is possible. The aggressiveness of the REVERSHIFT clutchless reverser is therefore adjustable in nine steps (-4 to +4), providing optimum ride comfort in all situations.



Auto-shift function.

Because you've got more important things to do, you can leave the QUADRACTIV or HEXACTIV to change gear automatically. If your ARION 400 has CIS, the auto-shift function can be set up with a wide range of well-designed functions to suit driver preferences and the job in hand.

The operator can choose between three auto-shift modes via the CIS terminal:

- 1 Fully automatic: the auto-shift function shifts for variations in engine speed depending on engine load, vehicle speed and the driver's preference / accelerator position
- 2 PTO mode: the auto-shift function shifts in such a way as to ensure the engine speed / PTO speed remains as constant as possible
- 3 Manual mode: the auto-shift function shifts according to a fixed engine speed which the driver can program in CIS



Manual shifting



Driving strategies



Manual shifting in field mode



Manual shifting in transport mode

Mode	Shifting
	<ul style="list-style-type: none"> - Press the rocker switch hard to shift range (A-D) - Tap the rocker switch to auto-shift gear (1-6)
	<ul style="list-style-type: none"> - Tap the rocker switch to shift all gears (A1-D6)

QUADRACTIV or HEXACTIV auto-shift





Driving strategies



Automatic shifting in field mode



Automatic shifting in transport mode

Mode	Shifting
	<ul style="list-style-type: none"> - Press the rocker switch hard to shift range (A-D)
	<ul style="list-style-type: none"> - Automatic powershift shifting (1-6)
	<ul style="list-style-type: none"> - Shift all gears (A1-D6) automatically
	

CLAAS tractor concept. No holding you back.

The CLAAS tractor concept.

The ARION 400 enables smaller farms to benefit from the technology normally reserved for the top performance class. The CLAAS tractor concept offers significant advantages which give you a clear competitive edge. The combination of a long wheelbase with optimum weight distribution (50% at the front, 50% at the rear) and a compact overall length ensures a high degree of versatility while maintaining impressive performance capabilities.

Long wheelbase and excellent weight distribution:

- high ride comfort
- good, safe road handling
- more pulling power and performance as less ballast is required
- greater stability for a higher lift capacity
- optimised fuel consumption
- lower ballast requirement protects the soil and guarantees dynamic road transport

Short overall length:

- good manoeuvrability
- short trailer combination on the road
- good visibility
- good guidance of front-mounted implements

A broad base.

The ARION 400 can be fitted with 38" rear tyres up to a diameter of 1.75 m. With a wide range of options, the ARION 400 is ready for any job, whether you choose road-optimised tyres with an industrial tread or low-compaction field tyres up to 600 mm wide.

Safety first.

The brakes handle the low tare weight from 4.7 t and high permissible gross weight of 8.5 t or 9.0 t with ease, guaranteeing maximum safety and stability – assisted by automatic four-wheel drive engagement on braking and the hydraulically supported high-pressure service brake. During braking, the front axle suspension automatically adjusts to the change in load; the tractor therefore retains its normal stability and safety even during sharp braking manoeuvres.

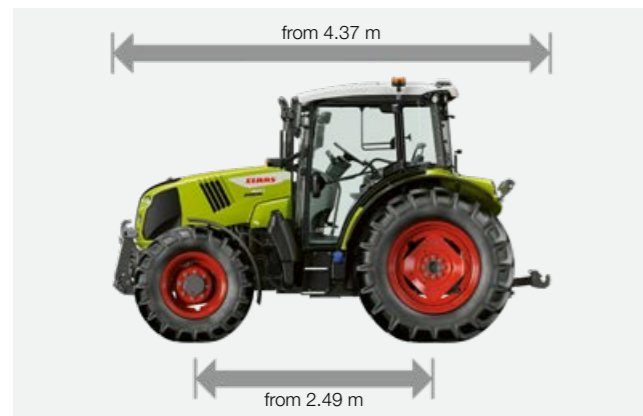
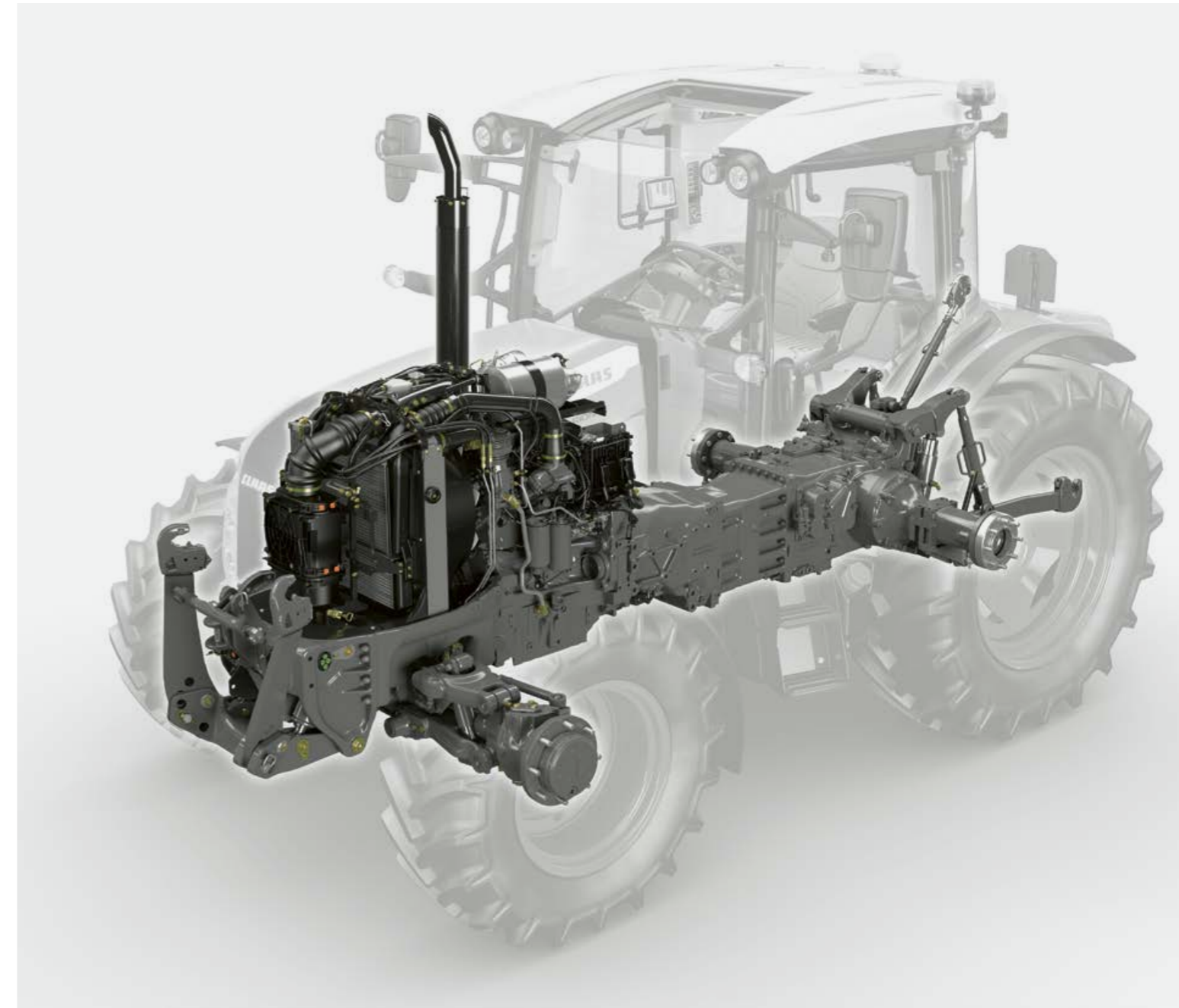

CLAAS tractor concept. More agile than ever.



Slim waist for tight turns.

Drawing on its combined experience in developing standard tractors to over 400 hp, CLAAS has designed a solution perfectly tailored to your needs.

The ARION 400 is an extremely robust and flexible tractor which makes your work as enjoyable as possible. Its sturdy cast frame with integral engine oil sump absorbs all the forces from the front linkage, front loader and front chassis. The front loader brackets are bolted directly onto the engine frame and transmission, allowing a front loader or front linkage to be retrofitted easily at any time.

The specially shaped front chassis provides plenty of space for the radiators immediately above the front axle, narrowing to the front and rear like a wasp waist. Together with the compact design, this gives the ARION 400 an excellent steering lock angle and small turning circles.



In practice, this means:

- maximum stability even when using heavy front-mounted implements and front loaders
- excellent steering lock angle even with wide tyres, for maximum manoeuvrability
- turning radius from just 4.25 m (420 / 410) or 4.5 m (440 / 430) and 4.9 m (470 / 450)
- unrestricted access to the entire engine compartment and all maintenance points

Steering angle-dependent four-wheel drive.

In addition to speed-dependent automatic four-wheel drive, the ARION 400 features a steering angle-dependent mode which you can deploy as and when required.

During field work when soil conditions are dry, steering angle-dependent automatic four-wheel drive can reduce the turning circle by up to 8%, allowing you to negotiate the headland more efficiently and reduce tyre wear. It also enables you to go easier on the grass sward and your crop during grass harvesting and field work.

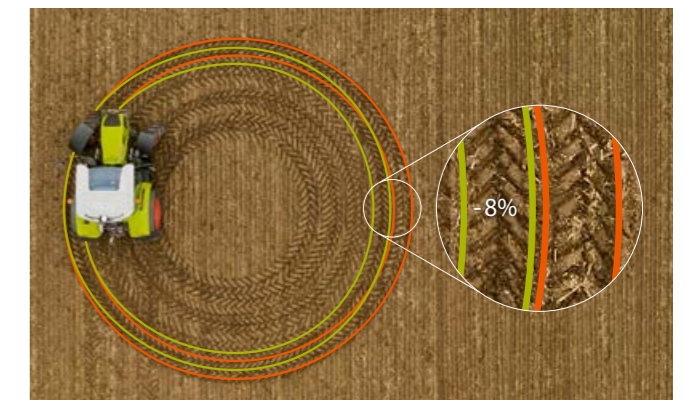

- Steering angle-dependent automatic four-wheel drive for up to 8% tighter turning circles
- Without steering angle-dependent automatic four-wheel drive



Up to 150 l/min hydraulic output.
Push the boundaries.



Well metered.

The basic system available is an open-centre hydraulic circuit with a hydraulic flow of 60 l/min. The optional open-centre hydraulic circuit delivers 100 l/min and operates as a twin-pump system. The first pump serves the rear linkage, while a second pump provides flow to the hydraulic spool valves. This allows the ARION 400 to perform these two functions simultaneously. In addition, the entire hydraulic capacity of the two pumps can be pooled and delivered to the spool valves. Ideal for intensive front-loader work or specialist hydraulic applications.

Work with 110 l/min or 150 l/min.

Load-sensing systems are available for the CIS and CIS+ version of the ARION which deliver a hydraulic output of 110 l/min or 150 l/min. The variable hydraulic pumps supply only the volume of oil that is actually needed for the task, avoiding any surplus. The 150 l/min circuit is enough to satisfy even large hydraulic consumers such as pneumatic seed drills effortlessly and powerfully. And when you don't need maximum hydraulic power, you can drive the ARION 400 at reduced engine speed and save valuable fuel.

Reap the benefits of Power Beyond connections.

- Hydraulic oil is supplied to the attached implement as required
- Large-diameter lines, flat-seal couplings and non-pressurised return flow reduce power losses



Power Beyond connections for the load-sensing circuit are provided at the rear for implements with their own control units. The implement then controls its own oil requirement, making permanent oil circulation unnecessary.



Customise your hydraulics.

Up to three mechanical or five electronic spool valves are also available. With the ARION 400 you can choose from a number of hydraulic equipment options and customise your tractor to suit the work you do on your farm: as an all-rounder with a front loader or as a field work specialist. Whether you want the convenience of high-tech solutions or the efficient basic version, the ARION 400 is always the perfect fit.



Convenient and precise control.

ELECTROPILOT integrated into the multifunction control lever makes light work of front loader operations, headland manoeuvres and round baling. You can perform any task without taking your right hand off the multifunction control lever, which is conveniently located in the armrest. So you can operate implements with greater precision without tiring and increase your work rate – when using a front-rear mower or seed drill combination, for example.

Simple, clean connections.

The spool valves at the rear of the ARION (up to four) are easy to connect. The colour-coded markings on the inlet and outlet sides make it easier to attach implements correctly.

Use up to five electronic spool valves and easily adjust:

- maximum flow rate in both directions
- time control
- 3-stage ELECTROPILOT response

Equipment	Standard	CIS	CIS+
Open-centre hydraulic circuit 60 l/min	●	●	-
Open-centre hydraulic circuit 100 l/min	□	□	-
Load-sensing circuit 110 l/min	-	□	●
Load-sensing circuit 150 l/min	-	□	□
Up to three mechanical spool valves at the rear	□	□	-
Up to four electronic spool valves at the rear	-	-	□
FLEXPILOT front loader spool valve (controlled via multifunction lever in the armrest)	□	□	-
Two central electronic spool valves, e.g. for front loader and front linkage, and an additional spool valve at the rear or switchover valve for dual use (controlled via multifunction lever in the armrest)	-	□	□

● standard □ available - not available

Rear linkage and PTO.

Designed to handle any implement.



A strong team.

With a maximum lift capacity of 4.50, 5.75 or 6.25 t, the electronic rear linkage is capable of handling any implement. The external controls for the rear linkage, an electronic spool valve and PTO are conveniently located on both mudguards. Practical holders for the lower link balls are also provided at the rear.

The rear linkage equipment meets every requirement:

- Manual or automatic lower link stabilisers
- Robust and simple top link holder
- Practical ball holder at the rear
- External controls for the rear linkage and PTO on both mudguards



Controls for the rear linkage, electronic spool valve and PTO are available for both mudguards. The left mudguard has a holder for four lower link balls.

Three-way convenience: the controls.

The electronic rear linkage has three types of controls:

- 1 On the ergonomic multifunction control lever you can access the quick raise, quick entry and working position functions for the rear linkage.
- 2 On the control panel on the right-hand side console you can also activate the quick raise, quick entry and working position functions for the rear linkage and press the stop button. The slide controller for depth control of the rear linkage, the hand throttle and other controls are also located here. This is particularly useful when working on the headland.
- 3 The rear linkage controls used during implement attachment are handily positioned on the right-hand B-pillar, as the driver turns round anyway when attaching implements.



The rear linkage can be operated from the side console or the multifunction control lever.



Always at the right speed.

Four different PTO options are available for the ARION 400:

- 540 / 540 ECO rpm
- 540 / 1000 rpm
- 540 / 540 ECO / 1000 rpm
- 540 / 540 ECO / 1000 rpm and ground speed PTO

The PTO speed is easily pre-selected by pressing a button on the right-hand B-pillar. A switch in the right side console switches the PTO on. Automatic PTO engagement/disengagement can be adjusted continuously by means of the rear linkage height. Simply move the rear linkage to the position required and press and hold the automatic PTO button – the engagement/disengagement position specified is now saved.

Implement attachment is very straightforward as the PTO stub rotates freely.

Standing start.

The ARION 400 transfers its full output to the 1,000 rpm PTO when it is stationary and also at low forward speeds. In ECO PTO mode the engine runs at a low, fuel-efficient speed. During light applications, the lower engine speed can reduce noise levels and save valuable fuel: 540 rpm ECO at 1,530 engine rpm.

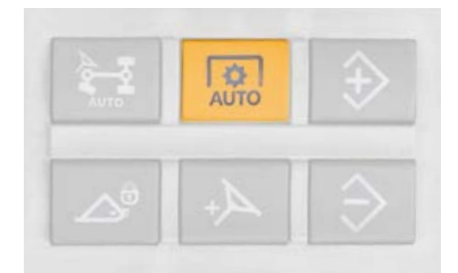

PTO engagement/disengagement is activated on the right-hand side console.



Versatility in every application with the powerful front linkage.



With electronic spool valves, the front linkage and additional spool valve can be controlled externally.

Integrated front linkage.

For safe, efficient work you need a powerful connection between the tractor and implement. The linkages on the ARION 400 provide an excellent starting point.

The compact, fully integrated front linkage has a maximum lift capacity of 3.3 t. In the CIS or CIS+ versions with electronic spool valves, it can also be controlled externally. Additional plug-in connectors for a spool valve on the front linkage are available on request.

Front linkage and front PTO.

- Three positions for the front lower links: folded up, fixed working position and float position in slotted hole
- Double-acting lift rams as standard
- Short distance between front axle and mounting points for improved guidance of front attachments

- 1,000 rpm PTO
- External controls for the front linkage and one electronic spool valve (requires CIS or CIS+ version with electronic spool valves)
- 7-pin socket available

CLAAS front loader. The perfect fit for your ARION.

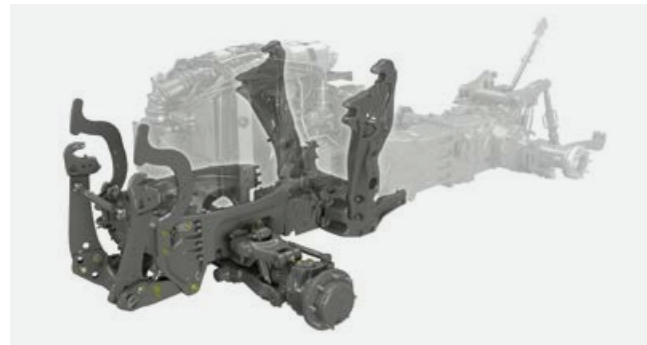

No compromises. Even with front loader work.

When developing the ARION 400 series, it was very important for the attachment brackets to be fully integrated into the overall tractor concept. The brackets are positioned a long way back, providing stability during heavy work. The robust connection to the innovative engine frame does not compromise steerability or ease of maintenance.

Two operating options.

The CLAAS front loader on your ARION 400 is operated via the multifunction control lever which is integrated into the armrest as standard. Depending on the equipment installed, you can choose between the FLEXPILLOT (hydraulically pilot-operated valve control) or ELECTROPILOT (electronic valve control). Both systems are designed for optimum ease of use, with control functions that are extremely smooth and easy to regulate.

Everything to hand.

The unique multifunction control lever combines control of the front loader with control of the transmission, engine and rear linkage. Your right hand stays comfortably positioned on the multifunction control lever – for faster loading. Naturally, the third and fourth front loader functions are integrated into the multifunction control lever. Your left hand steers and operates the REVERSHIFT lever when changing direction. For continuously variable restriction of the maximum lifting and lowering speeds when using the ELECTROPILOT, you can easily adjust the flow rates and responsiveness of the electronic spool valves for the front loader in the CIS display.

Low roof opens doors.

Doors only 2.50 m high are no obstacle with the low-profile cab. Thanks to the transparent sunroof, the driver still has excellent visibility.



PANORAMIC cab with continuous windscreen right through to the glass roof: minimum clearance height of 2.66 m.



High-profile cab with transparent sunroof: minimum clearance height of 2.66 m.



Low-profile cab with transparent sunroof: minimum clearance height of 2.50 m.



Clear benefits.

- Front loader brackets and controls can be factory-fitted
- All cabs are tested to FOPS guidelines (Falling Object Protective Structure)
- Two convenient control options available on the multifunction control lever: ELECTROPILOT or FLEXPILLOT
- PCH hydraulic self-levelling linkage on FL front loaders or mechanical self-levelling linkage on FL C and FL E models
- Automatic bucket return brings the front attachment back to the starting position at the press of a button
- The Synchro Control System enables the implement angle and a third function to be controlled with a single movement
 - handy for emptying a grab bucket, for example
- FITLOCK system for quick and convenient fitting / removal

- MACH quick-attachment coupler for electrical and hydraulic connections
- FASTLOCK hydraulic locking for implements
- SPEEDLINK for automatic locking and connection of all hydraulic and electric connectors on the implement
- SHOCK ELIMINATOR for vibration damping
- Wide selection of attachments
- And not forgetting the full CLAAS service

ARION	FL	FL C	FL E
470	120, 100, 80	120, 100, 80	100
460-460 M	120, 100, 80	120, 100, 80	100
450-450 M	120, 100, 80	120, 100, 80	100
440	120, 100, 80	120, 100, 80	100
430	120, 100, 80	120, 100, 80	100
420 M	120, 100, 80	120, 100, 80	100
420	100, 80	100, 80	100
410	100, 80	100, 80	100

All the freedom you could wish for.

Freedom means different things to different people. For some it means good all-round visibility, for others a more spacious interior with intelligently arranged controls. Some like to keep a clear head: combining the unrivalled sense of space with intelligent digital assistants that reduce the workload and increase efficiency.

The comfortable ARION cab lives up to all these expectations and is available in three equipment levels and four styles – including the PANORAMIC cab. Designed to make your job easier, so that you can focus on a productive day's work. And on arguably the best kind of freedom: finishing just a little bit earlier.



Dear ARION fans.

My name is Tom Seyer and I am sales product manager at CLAAS. Our new ARION 400 has already acquired a large fan club. Hardly surprising in my view, since no other tractor on the market has a multifunction control lever and multipad like this!

The ARION cab. More relaxed means more productive.



Six pillars. 360° visibility.

Tractor drivers often work very long days. To stay healthy, they need a suitable workplace which can be adjusted flexibly to suit the broad spectrum of work performed by the tractor. The 6-pillar cab makes it possible to work in comfort and satisfies the needs of even the most demanding drivers – with optimum visibility, maximum protection and a very high level of comfort.

- Continuous windscreen
- Six narrow pillars for 360° visibility
- Doors with a wide opening angle – thanks to the 6-pillar design, they protrude only a short distance beyond the tractor contours even when open
- Easy access from both sides of the tractor
- All cab versions conform to FOPS (Falling Object Protective Structure) for protection against falling objects
- Spacious cab design offers extra room
- Steering column is easily adjusted by pressing a pedal
- Cooled drinks compartment under the passenger seat
- Transparent sunroof for high- and low-profile cabs

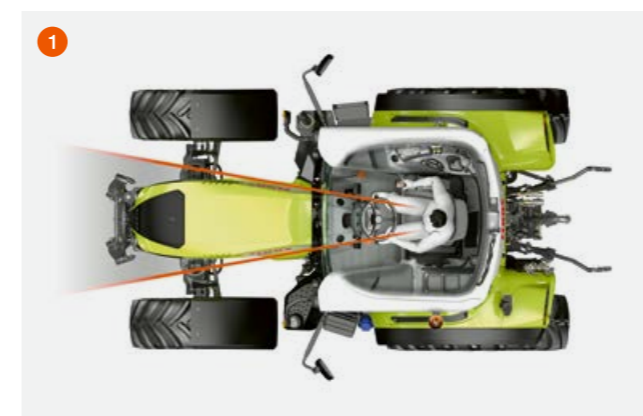
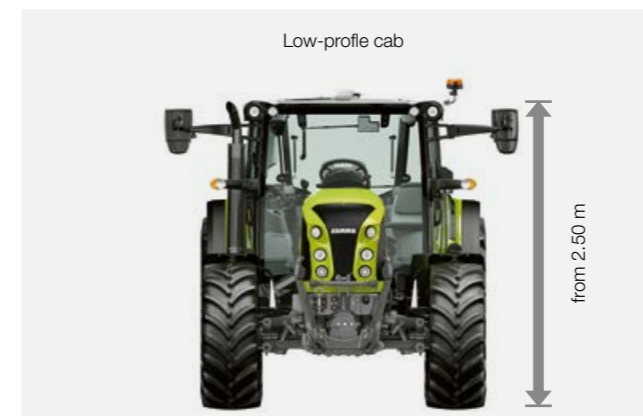

Four cab options.

The ARION 400 offers four different cab versions. Just choose the one that suits you best:

- PANORAMIC cab with continuous windscreen right through to the glass roof for maximum visibility, with a minimum overall height of 2.66 m
- High-profile cab with roof hatch or transparent sunroof and minimum overall height of 2.66 m
- Low-profile cab with transparent sunroof and minimum overall height of 2.50 m
- 5-pillar cab¹ with roof hatch or transparent sunroof, large continuous and shatter-proof polycarbonate side window and minimum overall height of 2.71 m; ideal for municipal work

Superb visibility with the PANORAMIC cab.

Ideal for all front-loader work: the continuous field of view covers a 90° angle from the driver's perspective. This unique cab design has no cross beams to get in the way and offers an extremely high level of safety and comfort. From the floor through to the roof, the continuous 2.41 m² glass front guarantees optimum visibility.

Intelligently designed for a clear view.

The tapered bonnet (1) becomes narrower downwards and towards the driver to provide optimum visibility.

¹ Only available with the ARION 460 M, 450 M and 420 M

ARION 400 M.

Get the complete picture, get more done.

Clearly designed for municipal work.

The ARION 400 M has been developed specifically for municipal work. Its spacious 5-pillar cab is equipped with a continuous shatter-proof polycarbonate side window. All three models in the series provide a high level of safety and a clear view of the working area, such as the rear boom mower, for example. The intuitive multifunction control lever built into the arm rest takes the strain out of front loader operations.

Unrestricted view to the right.

The 8 mm thick right side window is made from shatter-proof polycarbonate. Measuring 3 m², it offers an impressive angle of view of 58° vertically and 80° horizontally. Wide-angle windscreen wipers and a sun visor ensure a clear view of your work area, whatever the weather. The large-format transparent sunroof is FOPS-compliant to provide protection against falling objects.

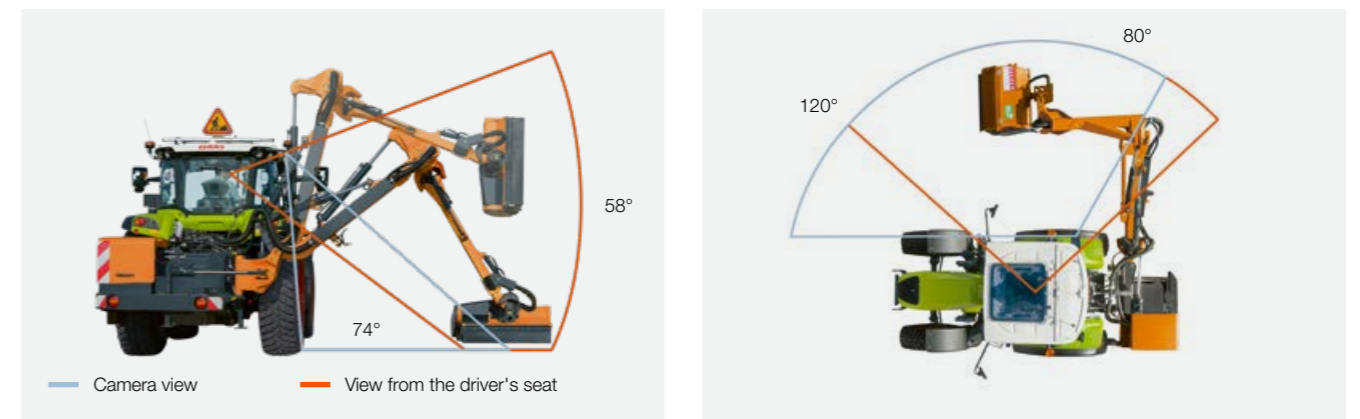

The generous view of the work area afforded by the right side window is amplified by a camera mounted securely on the right side of the cab roof. The camera eliminates the blind spot and helps you to judge obstacles and distances more accurately.



Camera for greater safety.

The camera, which is adjustable in two directions, significantly extends your field of view. When mowing banks and ditches, you can even get a clear view of the flail mower when it is close to the tractor wheel. The high-resolution camera display is mounted on the A-pillar directly in your field of view. You can configure it in portrait or landscape mode as required.

- Camera angle: 120° x 74°
- Resolution: 1280 x 800 pixels



ARION 400 M.

There's a lot to be done.



Mowing, mulching, loading.

The ARION 400 M is equipped to tackle any municipal task. Make the most of its comfortable equipment and features designed specifically for municipal work.

- QUADRISHIFT or HEXASHIFT transmission
- SMART STOP function
- Hydraulic circuit delivering up to 150 l/min
- CLAAS front loader
- Cab variants: Standard, CIS or CIS+
- FLEXPILOT or ELECTROPILOT
- Suspended cab and front axle
- Camera for right-hand work area
- Fittings for warning sign on cab roof
- 9 t permissible gross weight
- Tyres with industrial tread
- Wheel ballasting
- TELEMATICS



You can add up to 270 kg of ballast to the left rear wheel to offset the weight of the telescopic boom for safe, stable road travel

Built for heavy lifting.

Make short work of tough loading operations with the ideal weight distribution, REVERSHIFT clutchless reverser, transparent sunroof and multifunction control lever. Features such as the SMART STOP function, dynamic steering, ELECTROPILOT and the powerful hydraulic circuit with an output of 110 l/min or 150 l/min help get your loading work done quickly and fuel-efficiently.

Unbeatable with the CLAAS front loader.

- PCH hydraulic self-levelling linkage on FL front loaders or mechanical self-levelling linkage on FL C and FL E models
- FITLOCK system for quick and convenient fitting/removal
- MACH quick-attachment coupler for electrical and hydraulic connections
- FASTLOCK hydraulic locking for implements
- SPEEDLINK for automatic locking and connection of all hydraulic and electric connectors
- SHOCK ELIMINATOR for vibration damping



ARION	Maximum torque in Nm ¹	Maximum output in hp ¹	Permissible gross weight in t
460	573	135	9
450	539	125	9
420	434	100	9

¹ ECE R 120

Three versions. Each a perfect fit.

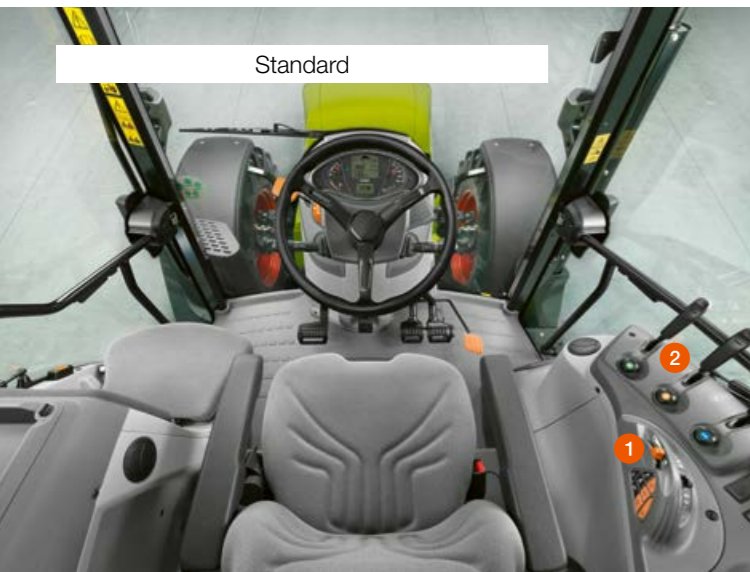

High standard. Simply good.

In the basic version, the ARION features mechanical spool valves (2) and operation of the transmission from the multipad (1) on the right-hand console. With numerous other equipment options to choose from, you can select exactly the right set-up for your main application: HEXASHIFT transmission for frequent road use or FLEXPILLOT for front loader operations. Concentrate on what's important.

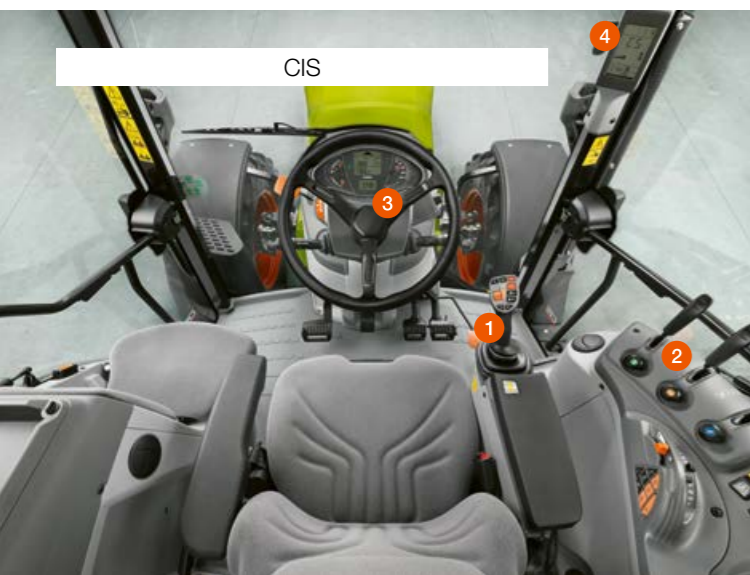

CIS. Simply more.

If you want more setting options from the ARION 400 even with mechanical spool valves (2), the CIS version is the way to go. The multifunction control lever (1) built into the armrest offers greater convenience. With the CIS display (3) and additional transmission display (4), you can see all the settings at a glance. The CIS version is also available with two electronic spool valves which can be used to control the front loader, front linkage or an additional spool valve at the rear.

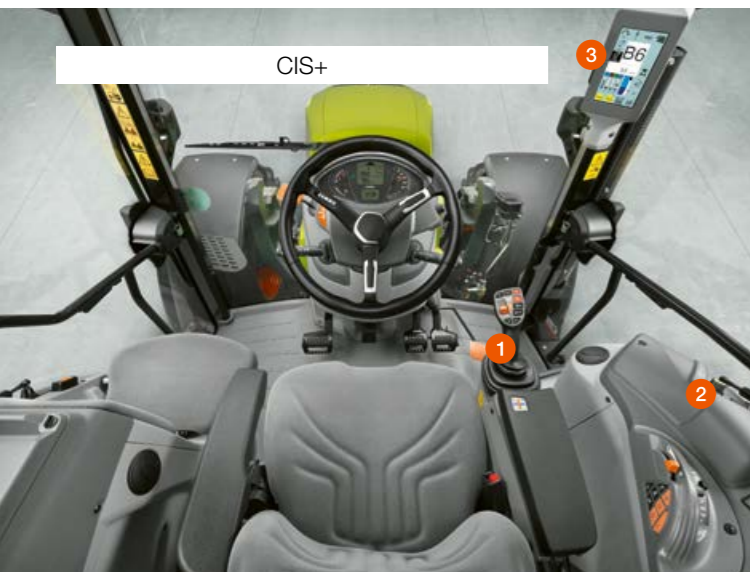

CIS+. Simply everything.

With the multifunction control lever (1) and electronic spool valves (2), CIS+ offers outstanding convenience and intuitive design. Despite its pleasing simplicity, it has all the necessary functionality and the automatic functions needed for effective, effortless operation. The 7" CIS colour display (3) built into the A-pillar combines display and setting options for the transmission, electronic spool valves, F buttons and CSM headland management. The CIS+ is everything you could wish for.

A cab and tractor tailored to your needs.

Every customer has individual preferences and wants the tractor best suited to their needs. That's why CLAAS has developed three different versions – Standard, CIS and CIS+. With these three alternatives, numerous other options and four cab styles to choose from, you're sure to find the right ARION 400 for you.



ARION features	Standard	CIS	CIS+
CIS display on the instrument panel and transmission display on the A-pillar	<input type="checkbox"/>	<input checked="" type="checkbox"/>	<input type="checkbox"/>
CIS colour display on the A-pillar	<input type="checkbox"/>	<input type="checkbox"/>	<input checked="" type="checkbox"/>
Multifunction control lever			
Without multifunction control lever	<input checked="" type="checkbox"/>	<input type="checkbox"/>	<input type="checkbox"/>
Multifunction control lever, fixed	<input type="checkbox"/>	<input checked="" type="checkbox"/>	<input type="checkbox"/>
Multifunction control lever with FLEXPILLOT function for front loader operation	<input type="checkbox"/>	<input type="checkbox"/>	<input type="checkbox"/>
Multifunction control lever with ELECTROPILOT function	<input type="checkbox"/>	<input type="checkbox"/>	<input checked="" type="checkbox"/>
Second engine speed memory	<input type="checkbox"/>	<input checked="" type="checkbox"/>	<input checked="" type="checkbox"/>
QUADRISHIFT transmission (16 F / 16 R)	<input checked="" type="checkbox"/>	<input checked="" type="checkbox"/>	<input checked="" type="checkbox"/>
HEXASHIFT transmission (24 F / 24 R – ARION 430 to 470 only)	<input type="checkbox"/>	<input type="checkbox"/>	<input type="checkbox"/>
Headland gear	<input type="checkbox"/>	<input checked="" type="checkbox"/>	<input checked="" type="checkbox"/>
QUADRACTIV or HEXACTIV auto-shift	<input type="checkbox"/>	<input type="checkbox"/>	<input type="checkbox"/>
Cruise control function for HEXASHIFT transmission	<input type="checkbox"/>	<input type="checkbox"/>	<input type="checkbox"/>
REVERSHIFT clutchless reverser on the multifunction control lever	<input type="checkbox"/>	<input type="checkbox"/>	<input type="checkbox"/>
SMART STOP	<input type="checkbox"/>	<input type="checkbox"/>	<input type="checkbox"/>
Dynamic steering	<input type="checkbox"/>	<input type="checkbox"/>	<input type="checkbox"/>
Steering angle-dependent four wheel drive	<input type="checkbox"/>	<input type="checkbox"/>	<input type="checkbox"/>
Automatic PTO engagement/disengagement	<input type="checkbox"/>	<input type="checkbox"/>	<input type="checkbox"/>
CSM headland management	<input type="checkbox"/>	<input type="checkbox"/>	<input type="checkbox"/>
Open-centre hydraulic circuit 60 l/min	<input checked="" type="checkbox"/>	<input type="checkbox"/>	<input type="checkbox"/>
Open-centre hydraulic circuit 100 l/min	<input type="checkbox"/>	<input checked="" type="checkbox"/>	<input type="checkbox"/>
Load-sensing circuit 110 l/min	<input type="checkbox"/>	<input type="checkbox"/>	<input checked="" type="checkbox"/>
Load-sensing circuit 150 l/min	<input type="checkbox"/>	<input type="checkbox"/>	<input type="checkbox"/>
Up to three mechanical spool valves at the rear	<input type="checkbox"/>	<input type="checkbox"/>	<input type="checkbox"/>
Up to four electronic spool valves at the rear	<input type="checkbox"/>	<input type="checkbox"/>	<input type="checkbox"/>
FLEXPILLOT front loader spool valve	<input type="checkbox"/>	<input type="checkbox"/>	<input type="checkbox"/>
Two electronic spool valves in the centre via ELECTROPILOT, e.g. for front linkage, and additional spool valve at the rear	<input type="checkbox"/>	<input type="checkbox"/>	<input type="checkbox"/>
GPS PILOT	<input type="checkbox"/>	<input type="checkbox"/>	<input type="checkbox"/>
TELEMATICS	<input type="checkbox"/>	<input type="checkbox"/>	<input type="checkbox"/>

● standard □ available – not available

Multifunction control lever and multipad. No one else offers this unique combination.

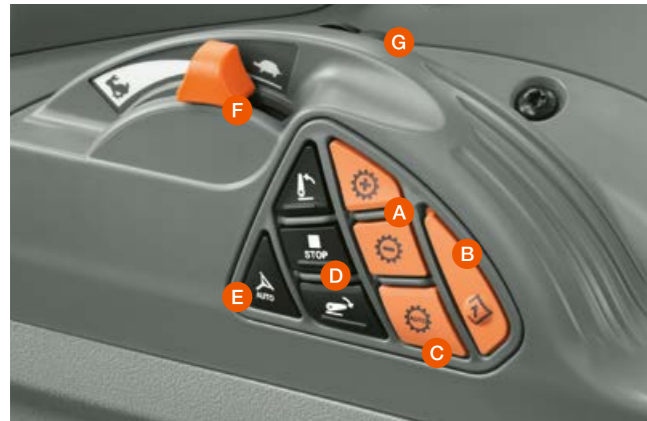

The multipad.

The multipad combines all key functions in a compact control panel on the right-hand console. Its ergonomic design keeps the hand in a relaxed position, giving you flexible control of the ARION 400 even at the headland.

Features of the multipad:

- A "+" and "-" buttons to control the powershift speeds and ranges of the QUADRISHIFT or HEXASHIFT transmission
- B Engine speed memory or cruise control
- C Activate QUADRACTIV or HEXACTIV auto-shift
- D Rear linkage
- E Activate GPS PILOT automatic steering system
- F Manual hand throttle
- G Slide controller for rear linkage depth control



With the multifunction control lever, even FLEXPILOT spool valve operation is conveniently at your fingertips.



Features of the multifunction control lever:

- 1 Rocker switch to control the powershift speeds and ranges of the QUADRISHIFT or HEXASHIFT transmission
- 2 Activate the ELECTROPILOT 4-way control lever function of the multifunction control lever
- 3 Switch between electronic spool valves available on the multifunction control lever
- 4 Headland gear
- 5 Engine speed memory or cruise control
- 6 Rear linkage or function buttons F1 / F2
- 7 Function buttons F3 / F4
- 8 ELECTROPILOT or FLEXPILOT spool valve operation
- 9 ELECTROPILOT or FLEXPILOT spool valve operation
- 10 Activate clutchless reverser on the rocker switch
- 11 Activate float position
- 12 Stage (blue): shift powershift speeds up and down
- 13 Stage (green): shift ranges up and down
- 14 Stage (blue) and button (orange) at the same time: REVERSHIFT clutchless reverser

The multifunction control lever.

The multifunction control lever developed in conjunction with users makes control of the transmission, front loader, rear linkage and spool valves more straightforward and user-friendly than ever, so you only need your left hand for steering.

Your right arm lies comfortably on the armrest while you control all the functions of your ARION 400 with the handy multifunction control lever. The height and position of the armrest can easily be adjusted to the driver's requirements.

The four-way control function of the multifunction control lever also allows two spool valves to be operated simultaneously: either via the hydraulically pilot-controlled FLEXPILOT function for the front loader or via the ELECTROPILOT function for different electronic spool valves, such as the front loader, front linkage and rear spool valves.

The four freely programmable F buttons offer even greater operational flexibility. You can assign the buttons to the appropriate functions for the job in hand, allowing you to operate the front loader, ISOBUS, spool valves or CSM without repositioning your hand.

Everything in hand.

You can select all forward and reverse gears with a one finger using the two-stage rocker switch on the multifunction control lever, without touching the clutch pedal:

The side console. Intuitive by design.



Perfectly ergonomic.

The key to relaxed and effective working: the side console is the result of extensive analyses of the operating processes in the cab. Frequently used functions are located on the multipad and the multifunction control lever.

- 1 Electronic or mechanical spool valves
- 2 Control panel – main functions:
 - differential lock
 - four-wheel drive
 - road and field mode
 - hydraulic pump aggregation
 - activate front axle suspension
- 3 Electronic switches for creep gear range

- 4 Main switch (hydraulics, steering system, battery)
- 5 Control panel – additional functions:
 - steering angle-dependent automatic 4-wheel drive
 - safety switch for front loader attachment locking
 - activate automatic PTO engagement/disengagement
 - activate dynamic steering
 - fine tune engine speed memory and cruise control
- 6 Activate front and rear PTO
- 7 Multipad



Maximum convenience and performance. The electronic spool valves.

With load-sensing hydraulics and electronic spool valves, the ARION 400 CIS+ sets new standards. The multifunction control lever and up to two rocker switches in the side console provide proportional control of up to five electronic spool valves. Flow rate and time control can be programmed quickly in the CIS colour display. Press the rocker switches hard to activate time control or continuous flow to the valve; press them lightly for proportional control.



Settings made simple.

Each mechanical spool valve has its own rotary switch which is used to select the different function options for each spool valve:

- Rotary switch in position IIII: Pressure – / Neutral / Pressure + / Float position
- Rotary switch in position III: Pressure – / Neutral / Pressure +
- Rotary switch in lock position: Spool valve locked in pressure position for permanent operation or in neutral position

Uncluttered layout.

The switches for electronic linkage control and pre-selection of PTO speeds are located on the right-hand B-pillar. This guarantees direct access while work is in progress and allows the driver to optimise the electronic linkage control setting when looking backwards. Two additional buttons for raising and lowering the rear linkage also make it easier to attach implements.

- A PTO speed selection
- B Rear linkage operation
- C Rear linkage status display
- D Electronic linkage control settings



Intuitive layout to boost your efficiency.

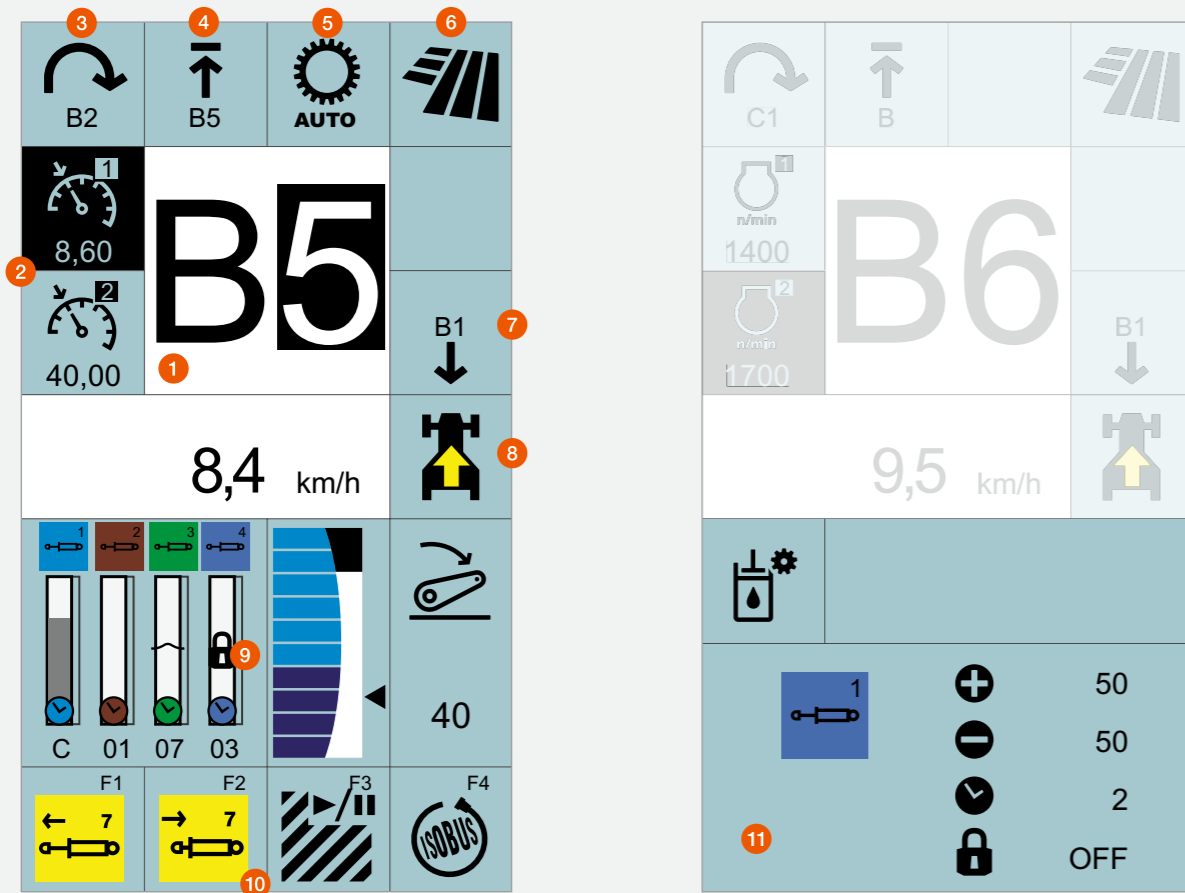

Colour CIS display on the A-pillar with integrated settings menu.

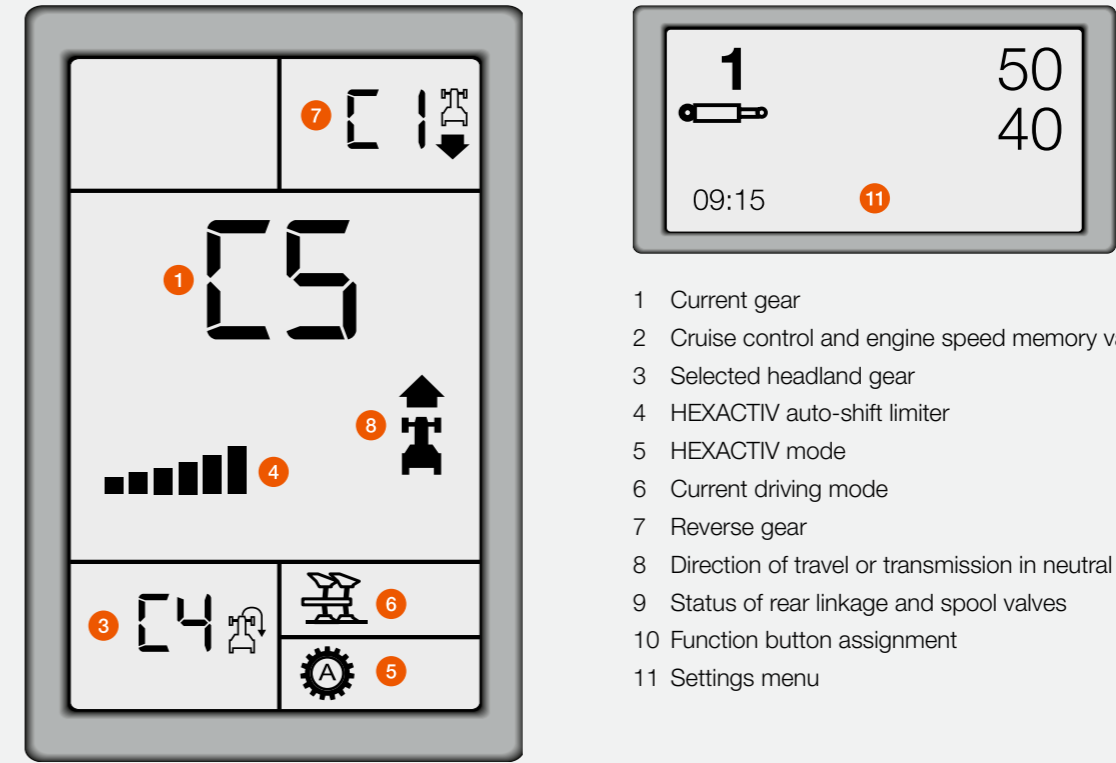

CIS display on the instrument panel and transmission display on the A-pillar.

- 1 Current gear
- 2 Cruise control and engine speed memory values
- 3 Selected headland gear
- 4 HEXACTIV auto-shift limiter
- 5 HEXACTIV mode
- 6 Current driving mode
- 7 Reverse gear
- 8 Direction of travel or transmission in neutral
- 9 Status of rear linkage and spool valves
- 10 Function button assignment
- 11 Settings menu

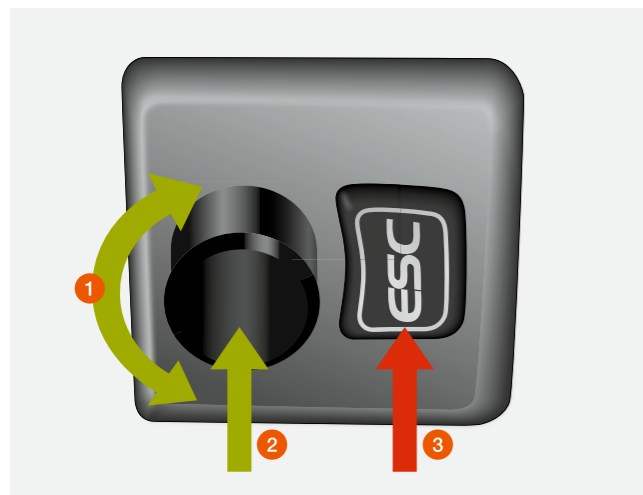

The colour CLAAS INFORMATION SYSTEM (CIS).

The modern design of the 7-inch colour CIS display on the A-pillar provides the driver with full information about the transmission, electronic spool valves and F buttons. This colour CIS display shows the settings in the lower part of the screen. The logical, menu-guided interface and clear symbols make navigation very simple.

- 1 Menu navigation
- 2 Select
- 3 ESC button

The CLAAS INFORMATION SYSTEM (CIS).

In this equipment option, the CIS display is built into the instrument panel. Thanks to the self-explanatory, menu-guided interface and icons, even inexperienced drivers can find the right settings with ease. The additional transmission display on the A-pillar shows all the information about the transmission at a glance.

The settings for both displays can be selected conveniently using a rotary/push switch and the ESC button on the steering wheel.

The following functions can be set using the CIS:

- Start-up and approach gears for the transmission
- Shift points for the HEXACTIV or QUADRACTIV auto-shift
- Progressivity of the REVERSHIFT clutchless reverser
- Independent forward and reverse gears
- Time and volume settings or responsiveness for the electronic spool valves
- On-board computer functions such as area covered, fuel consumption, area output
- Maintenance interval display

Relax. You've got a long day ahead.

First-class comfort.

The ARION 400 offers a host of convenient features to make long working days seem short. A comfortable seat, ample storage space, a generous cooler compartment and powerful air conditioning create a relaxing work space designed to make you feel at ease every minute of your working day.



A pleasant working environment.

The standard equipment on the ARION 400 includes a highly efficient heating and ventilation system with continuously variable fan control. A manually operated or automatic air-conditioning system is naturally available on request. The ventilation system can optionally be equipped with fittings for a category 3 filter (to EN 15695) for crop spraying. The active carbon filter is available from your CLAAS dealer.

Comfortable and safe – right from the start.

The 6-pillar cab design allows the door to open wide with little overhang. This makes it easier to access the cab and protects the door from damage.

As well as the manually controlled air-conditioning system, a fully automated version is available which provides a pleasant flow of air through the cab.



Clear and logical layout.

The instrument panel is mounted on a fully adjustable steering column. It pivots with the column to give an unimpeded view of the controls at all times.



Non-slip leather steering wheel.

The robust leather steering wheel provides a secure grip and an uninterrupted view of the instrument panel whatever position it's in.



Grammer Dual Motion seat.

The driver's seat with low-frequency air suspension is designed to protect your back. As you turn towards the implement, the seat and headrest swivel round with you by up to 15°.



Sockets in easy reach.

The cab has power sockets and connections for ISOBUS-enabled terminals.



All in full view.

The mounting bracket for the terminal is within easy reach of the driver while at the same time allowing unrestricted access to the cab through the right-hand door.



Keep cool.

The cooler compartment under the passenger seat has room for a 1.5 l bottle and snacks. Perfect for your lunch break.



LED work lights.

Up to eight LED work lights illuminate the entire area around the ARION almost as brightly as daylight for more demanding night-time work.



Bluetooth mobile phone connection.

With the built-in Bluetooth handsfree device with external microphone, you can make clear calls from the comfort of your cab.



Space for mobile phone and documents.

Handy storage compartments on the left side console ensure that everything is within easy reach. A 12 V socket is provided for charging mobile phones.

You can be more productive when you're sitting comfortably.

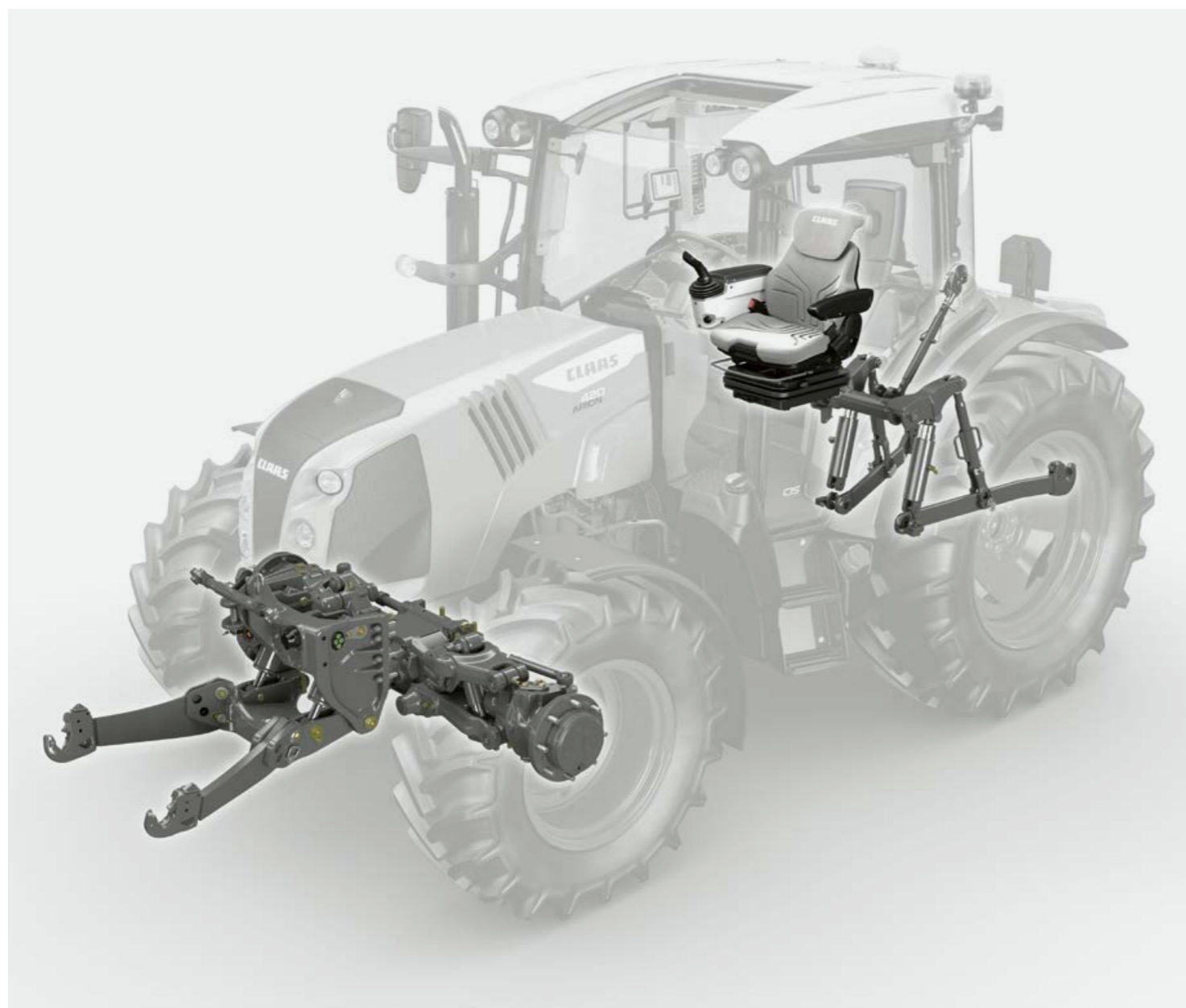

Comfort to match its bigger brothers. ARION 400.

For long and demanding working days, comfort is no longer a luxury confined to top-of-the range machines – it's an essential requirement. The new ARION 400 provides comfort right down to the smallest details.



PROACTIV front axle suspension. Complete comfort, automatically.

Independent wheel suspension and 90 mm spring travel guarantee a very smooth ride. The suspension adjusts to tractor loading and automatically remains in the central position. It also compensates for changes in load due to braking and turning manoeuvres.



Vibration damping at front and rear.

Heavy implements mounted on the front and rear put a strain on the tractor as well as the driver. Both the front and rear linkage are equipped with vibration damping to compensate for peak loads.



Cab suspension for enhanced comfort.

The mechanical 2-point cab suspension available in the ARION 470-430 offers greater driving comfort in every situation. And the entire suspension system is completely maintenance-free. When combined with PROACTIV front axle suspension, the ARION 400 satisfies even the most demanding requirements.



Low-frequency suspension. The premium seat.

The wide choice of Sears and Grammer seats includes two pivoting premium seats with low-frequency air suspension.

- Suspension automatically adjusts to the driver's weight
- Rotating seat console makes it easier to see implements

In future the tractor will do the thinking too.

Operator assistance systems and data management.

There is no substitute for your experience. It's what allows you to respond quickly and appropriately to the challenges you face in your daily work. When you're dealing with difficult terrain or changing soil conditions, you have to make decisions very quickly to get the job done to the right standard. So it's good to know you can count on an intelligent tractor to assist you.

Data have long since become an indispensable resource. To profit from their full potential, you should take just as good care of your data as you do your machinery fleet. And that includes making sure all systems, machines and processes are meaningfully connected.



Dear ARION fans.

My name is Catharina Kirchbeck and I work in marketing at CLAAS. What do I get really excited about? Operator assistance systems, data management and connectivity for productive, sustainable farming. And a tractor you can rely to have everything covered. For me, that's freedom. How do you define freedom?



CSM and dynamic steering. An ARION almost drives itself.



Activate CSM sequences conveniently using the function buttons on the multifunction control lever.

CLAAS SEQUENCE MANAGEMENT (CSM).

The CSM headland management system takes the load off you during all turning manoeuvres in the field. You can run any of the previously recorded functions simply by pressing a button.

With CSM you can:

- record up to four sequences
- activate, terminate prematurely or interrupt sequences
- view sequences on the CIS colour display

The following functions can be combined in any order:

- Spool valves with time and flow control
- Four-wheel drive, differential lock and front axle suspension
- Front and rear linkage
- Headland gear
- Front and rear PTO
- Engine speed memory
- Cruise control function
- HEXACTIV or QUADRACTIV auto-shift



In steering angle-dependent mode, the steering ratio when driving in a straight line is greatly reduced, making the steering more sensitive. The more the driver steers, the faster the steering responds. This is ideal for applications such as front loader work. The driver can steer the tractor in a straight line with great precision but still manoeuvre quickly.

In speed-dependent mode, the steering ratio is proportionally reduced as the forward speed increases above 10 km/h. This is particularly useful during field work. It allows fast and light turning at the headland. For faster work the steering ratio is reduced again to make it easier to drive straight ahead.

In manual mode, the steering wheel/steering angle ratio is permanently linked to the four adjustable assistance levels.

Easy to record and run.

The sequences are recorded continuously. Clear icons on the CIS colour display allow you to follow the sequence step by step as it is created.

You can pause a running sequence and resume it later simply by pressing a button.

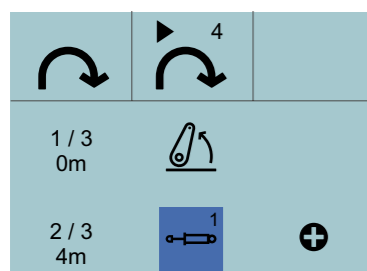

The sequence flow is shown in the lower area of the CIS colour display.

Dynamic steering.

Dynamic steering from CLAAS enables you to adjust the ratio between the steering wheel and front axle steering angle in several steps to suit your preferences. Using the CIS display, you can choose between two automatic programs and one manual mode.

The two automatic programs help the driver by changing the steering ratio to match the forward speed or current steering lock. This means that the system can be individually adjusted to suit all requirements.

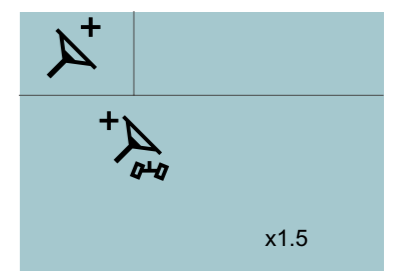

In the CIS display you can select three dynamic steering modes and the corresponding level of steering assistance.

GPS PILOT CEMIS 1200.

Precision farming made easy.

Precise, future-proof, simple.

Improve the profitability of your farm and simplify day-to-day operations – step into the future with the CEMIS 1200 terminal.

With the GPS PILOT automatic steering system, your harvesting machine will seem like it's running on rails: always on the right track, using the full working width with no overlapping. There's no need for a long induction course. You'll be surprised how easy it is to operate an automatic steering system using the intuitive CLAAS user interface.

Thanks to ISOBUS and standard data exchange formats, the CEMIS 1200 is the way forward for more precision in farming.

CEMIS 1200 terminal.

The CEMIS 1200 fits seamlessly into the cab: with the same intuitive control logic as CEBIS, operators will quickly find their way around.

You can use the system on all CLAAS machines set up for GPS PILOT CEMIS 1200. The terminal and receiver can be transferred from one machine to another in next to no time, giving you complete flexibility and saving money into the bargain.

Benefits:

- Intuitive user interface for outstanding ease of use day and night
- Quick access to all important functions
- Freely configurable working areas for custom control

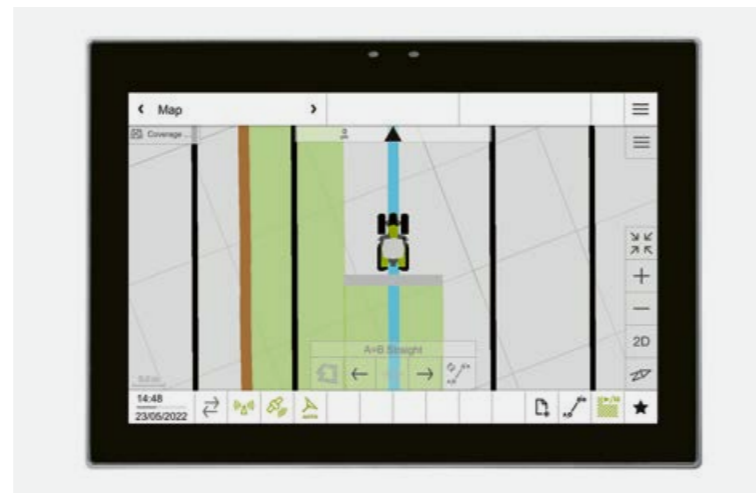

Cut your costs per hectare by increasing precision. steeringsystems.claas.com

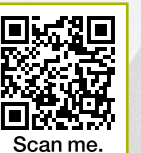

Scan me.

Precision guidance.

You need a good correction signal for precise work. It's a given with SATCOR 15¹ as standard for 5 years.

Need even greater accuracy?

Choose the optional SATCOR 3¹ and SATCOR 3 FAST¹ correction signals (± 3 cm).

Absolute precision your top priority?

Choose the GPS PILOT CEMIS 1200 with RTK correction signal for the highest possible repeatable accuracy ($\pm 2-3$ cm).

RTK Bridging.

All RTK correction signals are enhanced by the RTK Bridging function as standard, so if the signal is lost, work can continue for up to 20 minutes with gradually decreasing accuracy.

Difficult topography or mobile phone dead zones in your area?

With RTK Bridging Premium you can carry on working – without loss of accuracy or time limits.

¹ SATCOR 15 / SATCOR 3 / SATCOR 3 FAST powered by Trimble RTX. SATCOR correction signals, RTK Bridging and RTK Bridging Premium are not available in all regions. Together with your CLAAS distributor, we will find the best solution for your individual requirements.

GPS PILOT CEMIS 1200. Moving with the times.



 **Future-proof – GPS PILOT CEMIS 1200.**

With GPS PILOT CEMIS 1200, you get a terminal fit for the future. Tailor-made for your farm, with full functionality pre-installed or added gradually to suit your growing needs.

Still not sure? Why not test additional functions and correction signals free of charge in advance?

Perhaps your requirements have changed during the season? No problem – with the digital connection you can adapt the system's functions quickly and flexibly to suit your needs. The appropriate licence or activation can be transferred online straight to your terminal.¹

 **ISOBUS Universal Terminal (ISO UT).**

The ISO UT implement view can be displayed in the main work screen or in the smaller implement screen. This enables you to customise the display settings to suit your needs. The AUX-N allows functions to be assigned to physical function keys, for example on the CLAAS multifunction control lever.

- Benefits:**
- Customisable display settings for ISOBUS implements in the CEMIS 1200 terminal
 - User-friendly operation using function keys
 - Transfer new licences online or activate directly on the terminal

 **ISOBUS TC Section Control.**

The ISOBUS functionality of the CEMIS 1200 allows you to switch sections on or off automatically – for all the precision and none of the hassle.

 **Precision farming and documentation with ISOBUS TC-GEO and VRA.**

With ISOBUS TC-GEO you can easily record geo-referenced data such as application rates. If you want to target applications to specific areas, simply add the VRA (Variable Rate Application) module.

 **Office and machine seamlessly connected. Task management.**

With the CEMIS 1200 you can handle your job management via your mobile phone connection in just a few clicks – it's standardised and convenient.

Plan your tasks in your farm management software and transfer them straight from 365FarmNet or other connected systems to the machine via TELEMATICS. The operator has all the tasks in sight and can quickly and easily send them back to the office on completion.

Assign, complete and document – seamlessly and reliably.

¹ in countries with CLAAS connect

A connected tractor is more productive.

Digitalisation pays.

Digitalisation is a key factor in increasing your productivity and efficiency. Data generated in completely different places can be collected and evaluated centrally. This conserves your resources and improves your business processes.

To enable you to get more out of the ARION and your other machines, CLAAS offers a range of modules which allow systems, technology and working processes to be connected with each other, regardless of the manufacturer. Intelligent digitalisation matched to the requirements of your farm can reduce your workload significantly.

- Transfer and document machine and job data quickly
- Manage individual machines and the whole fleet efficiently
- Analyse working processes carefully and optimise them
- Analyse fields easily and map yields precisely
- Call up and manage farm data with intelligent farm management software
- Transmit data from different manufacturers' machines to TELEMATICS smoothly
- Save valuable maintenance and service time with remote diagnostics

TELEMATICS records your success.

With TELEMATICS you can continuously retrieve and record work and performance data for your tractor. All data are transmitted via the mobile phone network from the machine to the server, where they are processed and stored. You can access and evaluate your data online in real time or retrospectively via the web portal or the TELEMATICS app. The Connected Documentation licence amalgamates all the data on a field-specific basis in the background. It is also possible to export your data to any current farm management software program.

CLAAS API connects your office to your fleet.

With the DataConnect function, CLAAS, 365FarmNet, John Deere, Case, Steyr and New Holland have created a direct, multi-manufacturer, industry-wide and open cloud-to-cloud solution. This allows you to control and monitor your entire machinery fleet in the CLAAS TELEMATICS portal – safe in the knowledge that all relevant data are exchanged securely, conveniently and fully automatically. Both systems are components of CLAAS TELEMATICS.

Remote Service costs you nothing.

Remote Service from CLAAS is an important machine networking element. It simplifies maintenance and service support significantly. The machine informs the service partner of an upcoming requirement for maintenance or sends immediate notification if a fault arises. The service partner has access to the relevant data and can prepare optimally for the intervention in both scenarios. CLAAS covers the cost of Remote Service for you during the first five years. All you have to do is give your consent.

NEW: CEMIS 1200 manages your jobs.

With CEMIS 1200 and an active Connected Documentation licence, you can do your task management online with just a few clicks. Plan your tasks in your farm management software and transfer them to the machine via TELEMATICS. The operator has all the tasks in sight and can quickly and easily send them back to the office on completion.

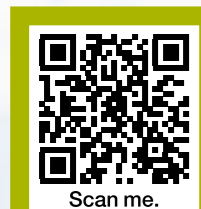

Connect your machines.
Optimise your jobs.

connected-machines.claas.com

Scan me.



Digitalisation puts your farm ahead.

- TELEMATICS transfers your data from your machine straight to the cloud
- DataConnect allows you to process data from your machines, regardless of manufacturer
- With CEMIS 1200 you can create and manage all jobs on the spot in the machine.
- Remote Service simplifies maintenance and service support



Quick and easy.

Daily maintenance work should be as straightforward as possible – because we know from experience that nobody enjoys doing things that are complicated or inconvenient.

- The one-piece bonnet opens at the press of a button, providing access to all the engine maintenance points
- The oil can be checked and topped up on the left-hand side of the ARION 400 when the bonnet is closed
- All daily maintenance tasks can be carried out without tools

Long oil-change intervals (engine 600 h, transmission and hydraulics 1,800 h) save a great deal of time and money. This means that less valuable working time is lost during the season and the tractor is where it should be – at work.

Fresh air for full power.

The large intake panels in the bonnet provide plenty of fresh air for cooling and for the engine air filter. Low flow rates at the intake panels help them to stay clean and permeable at all times. The radiator assemblies are supported by a robust frame and gas-filled shock absorbers open the radiator panels to two positions for thorough cleaning, which can be carried out safely and conveniently as required.

The air filter is in an accessible location in the cool zone in front of the radiator panels so there are no obstacles to removing it. The generously sized air filter is designed for a long service life. A pre-cleaner for coarse dirt particles in the filter housing further extends the cleaning interval.

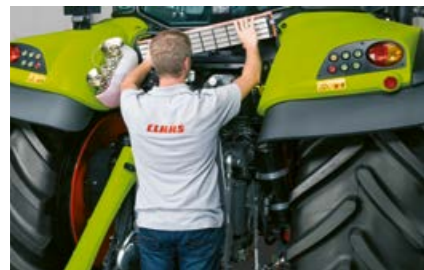

The cab air filter is behind the cab where it is easily accessible.



The engine air filter is located in front of the radiators and is easy to clean.



You can check the transmission and hydraulic oil level in a sight glass next to the PTO.



The battery, tool box and compressed air connection are located on the right side of the steps for easy access.

Whatever it takes.
CLAAS Service & Parts.



CLAAS Service & Parts
is there for you 24/7.
service.claas.com

Scan me.



Safeguard your machine's reliability.

Increase your operating reliability, minimise the risk of breakdown and repair. MAXI CARE offers you predictable costs. Create your own individual service package to meet your particular requirements.

Remote Service.

With Remote Service, all the relevant data from your telematics-equipped machines are made available to your service partner. This greatly simplifies the remote diagnostic process and the provision of remote support. Servicing can be carried out more efficiently and the level of machine readiness for use is enhanced. Remote Service is provided to you free of charge for a period of five years. All you have to do is give your consent.



Specially matched to your machine.

Precision-manufactured parts, high-quality consumables and useful accessories. Choose our comprehensive product range to be certain of receiving exactly the right solution to ensure 100% operating reliability for your machine.



For your business: CLAAS FARM PARTS.

CLAAS FARM PARTS offers one of the most comprehensive ranges of multi-brand parts and accessories for all agricultural applications on your farm.



Global supply.

The CLAAS Parts Logistics Center in Hamm, Germany, stocks almost 200,000 different parts and has a warehouse area of over 183,000 m². This central spare parts warehouse delivers all ORIGINAL parts quickly and reliably all over the world.



Your local CLAAS distributor.

Wherever you are, you can count on us to always provide you with the service and the contact people you need. Your CLAAS partners are on hand in your local area, ready to support you and your machine around the clock. With know-how, experience, commitment and the best technical equipment. Whatever it takes.

The ARION 400. Freedom is everything.



CLAAS POWER SYSTEM (CPS).

- Make use of up to 8% more torque with the FPT 4-cylinder turbo engines
- Benefit from the versatility of the ARION 400 afforded by the low power-to-weight ratio of just 34 kg/hp
- Shift gears without using the gear lever or clutch pedal
- Let QUADRACTIV or HEXACTIV do the shifting for you
- Bring your tractor to a standstill without depressing the clutch with SMART STOP
- Set two speeds in the cruise control and drive as effortlessly as if you had continuously variable transmission
- Use less ballast thanks to the 2.52 m long wheelbase and weight distribution of 50% at the front / 50% at the rear
- Reduce your turning circles by up to 8% with steering angle-dependent automatic four-wheel drive
- Enter buildings with low entrances with the low-profile cab (2.50 m overall height)
- Satisfy even your largest hydraulic consumers with the 150 l/min circuit
- Optimise your loading operations with the PANORAMIC cab, multifunction control lever and CLAAS front loader

Comfort and convenience.

- Choose your cab from three equipment options: Standard, CIS or CIS+
- Configure the multifunction control lever to suit your needs so you don't have to keep repositioning your hands
- Get a clear view of all implements thanks to the narrow-waisted bonnet and PANORAMIC cab
- Use the ARION 400 M with 5-pillar cab and special equipment for municipal work
- Protect your back with the air-suspended seat, cab suspension and PROACTIV front axle suspension
- Make the most of the automatic climate control and cooler compartment under the passenger seat in summer
- Turn night into day with the LED lighting
- Carry out all maintenance tasks in next to no time

Data management and operator assistance systems.

- Perform every function at the headland at the press of a button (CLAAS SEQUENCE MANAGEMENT)
- Manoeuvre effortlessly with dynamic steering
- GPS PILOT automatic steering and online task management via the CEMIS 1200 terminal
- Implement management
- TELEMATICS
- ISOBUS implement control via the CEMIS 1200 terminal

ARION		470	460	450	440	430	420	410	460 M	450 M	420 M
Rear linkage											
Lower and upper links with category 2 ball end		-	-	-	-	-	●	●	-	-	-
Lower and upper links with category 3 coupling hook		●	●	●	●	●	○	○	●	●	●
Max. lift capacity at ball ends	kg	5750	5750	5750	5750	5750	4500	4500	5750	5750	5750
Continuous lift capacity at 610 mm	kg	4200	4200	4200	4200	4200	3200	3200	4200	4200	4200
Max. lift capacity at ball ends with increased lift capacity	kg	6250	6250	6250	6250	6250	-	-	6250	6250	6250
Continuous lift capacity at 610 mm with increased lift capacity	kg	4700	4700	4700	4700	4700	-	-	4700	4700	4700
Vibration damping		●	●	●	●	●	●	●	●	●	●
External controls		●	●	●	●	●	●	●	●	●	●
ISOBUS socket		○	○	○	○	○	○	○	○	○	○
25 amp socket		●	●	●	●	●	●	●	●	●	●
Front linkage											
Max. lift capacity at ball ends	kg	2800	2800	2800	2800	2800	2800	2800	2800	2800	2800
Front PTO 1000 rpm		○	○	○	○	○	○	○	○	○	○
Vibration damping		●	●	●	●	●	●	●	●	●	●
External operation		○	○	○	○	○	○	○	○	○	○
Additional hydraulic connections		○	○	○	○	○	○	○	○	○	○
Trailer socket		●	●	●	●	●	●	●	●	●	●
Cab											
High-profile cab		□	□	□	□	□	□	□	□	□	□
Low-profile cab		□	□	□	□	□	□	□	-	-	-
PANORAMIC cab		□	□	□	□	□	□	□	-	-	-
Standard		●	●	●	●	●	●	●	●	●	●
CIS		○	○	○	○	○	○	○	○	○	○
CIS+		○	○	○	○	○	○	○	○	○	○
Air conditioning		○	○	○	○	○	○	○	○	○	○
Automatic climate control		○	○	○	○	○	○	○	○	○	○
Passenger seat with integral cool box		○	○	○	○	○	○	○	○	○	○
Adjustable steering column		●	●	●	●	●	●	●	●	●	●
Dimensions and weights											
Centre of rear axle to top of high-profile cab (a)	mm	1965	1965	1965	1965	1965	1910	1910	1965	1965	1965
Centre of rear axle to top of low-profile cab (a)	mm	1851	1851	1851	1851	1851	1796	1796	-	-	-
Overall height (b) high-profile cab ²	mm	2715	2715	2715	2715	2715	2660	2660	2715	2715	2715
Overall height (b) low-profile cab ¹	mm	2576	2576	2576	2576	2576	2496	2496	-	-	-
Wheelbase (c)	mm	2525	2525	2525	2525	2525	2489	2489	2525	2525	2525
Overall length (without front ballast, without front linkage) (d)	mm	4444	4444	4444	4444	4444	4372	4372	4444	4444	4444
Ground clearance, front axle (e)	mm	492	492	492	479	479	454	429	492	492	492
Ground clearance, rear axle (excl. drawbar) (f)	mm	469	469	469	456	456	431	406	469	469	469
Weight	kg	5300	5300	5300	5200	5200	4800	4800	5300	5300	5300
Max. permissible total weight	kg	9000	9000	9000	9000	9000	8500	8500	9000	9000	9000

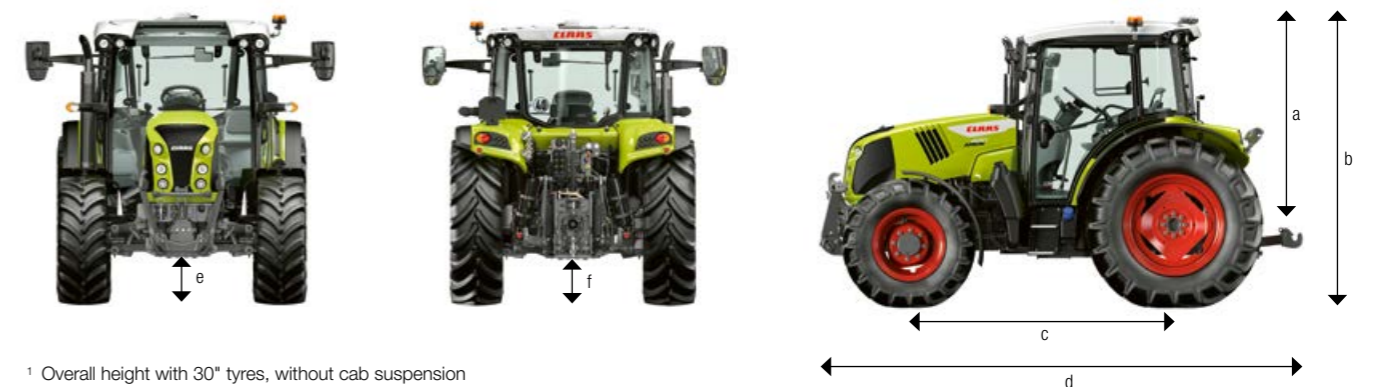

¹ Overall height with 30" tyres, without cab suspension
² Overall height with 34" tyres, without cab suspension



CLAAS UK
Saxham
Bury St. Edmunds
Suffolk
IP28 6QZ
Tel 01284 763100
claas.co.uk
info-uk@claas.com