



Combine harvesters

EVION

450 430 410





# Family matters. The new EVION.



Agriculture is a family matter. Especially when it's a tradition that's been followed for generations. And that makes getting a new machine a key moment for all concerned. Convenient, flexible and dependable, the EVION offers farms which operate with their own equipment the benefits of the best in engineering and technology. With its high level of cab comfort and intuitive operation, its unique MULTICROP capability and its refined drive concept, it ensures that you and your family will be able to enjoy harvesting for generations. Discover the EVION from CLAAS now. It's sure to win a place in your heart.

Combine harvester DNA	4
<b>EVION configuration</b>	<b>6</b>
Convenience	8
Flexibility	10
Dependability	12
<b>Front attachments, feeder housing</b>	<b>14</b>
<b>Crop flow</b>	<b>16</b>
Threshing unit	18
MULTICROP	20
Straw walkers, separation, cleaning	22
Grain collection, chaff and straw spreading	24
<b>CLAAS POWER SYSTEMS</b>	<b>26</b>
DYNAMIC POWER	28
Ground drive and drive system	30
<b>Cab and digitalisation</b>	<b>32</b>
Comfort cab	34
Control concept	36
Steering systems	38
Data management	40
Maintenance	42
CLAAS Service & Parts	44
Advantages	46
<b>Technical data</b>	<b>47</b>

See how well the new EVION suits your family.

Scan me.



# The EVION carries the genes of its big brothers.

Stable campaign performance, year after year.

For all their differences, the LEXION, TRION and EVION also have a great deal in common. Their crop flow technology is designed for high throughput, changing from one crop type to another is quick and easy, and their operator assistance systems help you to work efficiently and conveniently, plus much more.

## Unrivalled crop flow.

- CLAAS combine harvesters operate with uncompromising performance and impress with very high throughput under all harvesting conditions
- You benefit from their stable throughput right through the long working day
- The various front attachments are perfectly matched to the machine, allowing you to harvest any type of crop, no matter how demanding the requirements

## Outstanding user-friendliness.

- You and your operators are able to achieve extremely high performance and efficiency within a very short time
- Optional automatic functions and operator assistance systems mean that you only need to perform a few actions to get the best from your combine harvester
- When it is necessary for you to take control, the required actions are easy to understand and perform
- Whichever farm management software you are using, there is a seamless transfer of data from the machine to the system

## Exceptional comfort and convenience.

- CLAAS combine harvesters provide you with an environment in which you can work all day long
- Looking after the operator is the top priority
- The machine's maintenance requirements have been reduced to a minimum, allowing quicker machine service

## An impressively efficient system.

- With a CLAAS combine harvester, you are able to harvest with some of the lowest operating costs (fuel, wear parts and maintenance)
- You operate with low losses and high efficiency
- All the machines are integrated in a digital ecosystem that helps you improve your productivity across your entire harvesting process

## Reassuring dependability.

- CLAAS combine harvesters are reliable: the low level of downtime means that you can count on the operational availability of the machine
- CLAAS combine harvesters retain their value: they enjoy a high resale value on the used machinery market





# Configure the EVION that suits your family.

Agriculture is a family matter.

The choice of a new machine is a matter for all the family. Convenient, flexible and dependable, this combine harvester offers your family the best in engineering and technology. Get together to configure the EVION that precisely matches your requirements.

## Models

<b>EVION 450</b> 258 hp, 8,000 l grain tank capacity	<b>MAXI MULTICROP</b> 
	<b>CLASSIC Universal Grain</b> 
<b>EVION 430</b> 231 hp, 6,500 l grain tank capacity	<b>MAXI MULTICROP</b> 
	<b>CLASSIC Universal Grain</b> 
<b>EVION 410<sup>1</sup></b> 205 hp, 5,600 l grain tank capacity	<b>CLASSIC Universal Grain</b> 

<sup>1</sup> Only as Stage V

## Equipment packages

**BUSINESS or TREND**

**B T**

## Individual options

**Individual options**

**+**





Because convenience makes your harvest easier.



The intuitive control concept enables quick familiarisation with the machine.  
**Page 32**



The bright, high-resolution CEMIS 700 display tells you what you need to know at a glance.  
**Page 36**



Everyone can operate it.

When there's a lot of work to be done, the whole family lends a hand. And that includes the EVION. Its control concept is so straightforward and intuitive that everyone in your team can operate it, even in challenging harvesting conditions. Adjustments and maintenance tasks can be performed in next to no time.

**Convenience and comfort make you more productive.**

- The CMOTION multifunction lever and the clearly laid-out CEMIS 700 terminal are extremely easy to operate
- LED work lights, fully automatic air conditioning and a low noise level make for stress-free working, whatever the conditions
- Excellent accessibility makes it extremely easy for any user to perform maintenance tasks and machine adjustments
- The direct view into the returns and grain tank makes it even easier for you to monitor the crop
- CEMIS 1200 (optional) provides support for precision GPS tracking and connected documentation



Changeovers for different crops are quick and straightforward.  
**Page 20**

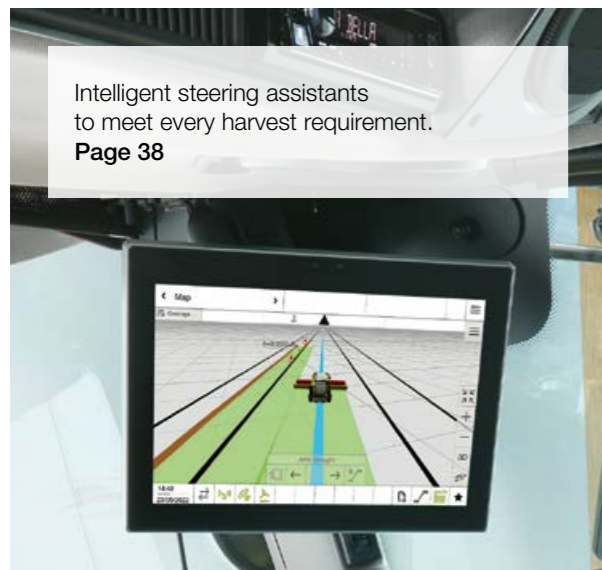

Intelligent steering assistants to meet every harvest requirement.  
**Page 38**



AUTO CROP FLOW monitors the speeds of key system components and protects against crop overload.  
**Page 18**



All maintenance points are easily accessible.  
**Page 42**

Learn all about the new EVION.  
[evion.claas.com](http://evion.claas.com)

Scan me.



Because flexibility increases your harvesting efficiency.

CLAAS has the right front attachment for every crop.  
**Page 14**



The differential lock and 800 mm wide tyres enable reliable progress in any terrain.  
**Page 31**



It adjusts to the way you work.

In a family, you know that you can always count on each other. Everyone is there for each other, and that includes the new EVION. Whatever the crop type you are harvesting or the conditions you encounter, it's a machine that adjusts quickly to new situations and works with you to deal with them effectively.

**Flexibility lets you work faster.**

- Short changeover times mean that you can switch from one crop to another in next to no time
- The MULTICROP threshing concave has what it takes to cope with any crop
- Suitable for use with any crop, the threshing drum handles straw and grains extremely gently, even at high throughput rates
- The differential lock on the front axle enables reliable progress in difficult soil conditions as well as in hilly terrain
- AUTO SLOPE adjusts the fan speed automatically and ensures that cleaning performance remains stable on slopes



The ability to swap out the concave segment makes crop type changes easier.  
**Page 20**



Chaff and straw are spread evenly across the working width.  
**Page 25**



AUTO SLOPE maintains full cleaning performance on slopes.  
**Page 22**



Because dependability will be appreciated for generations.

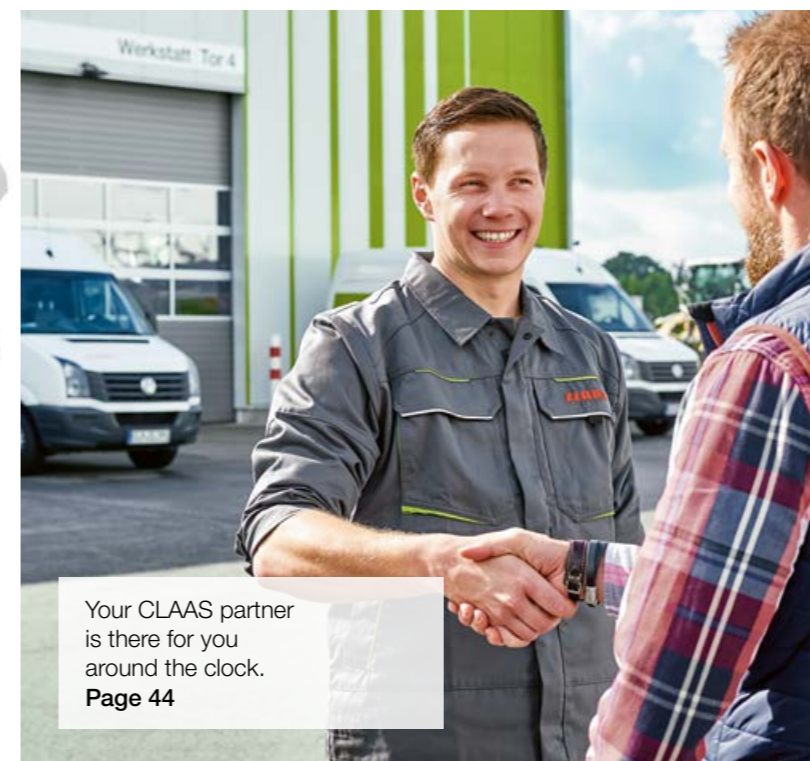
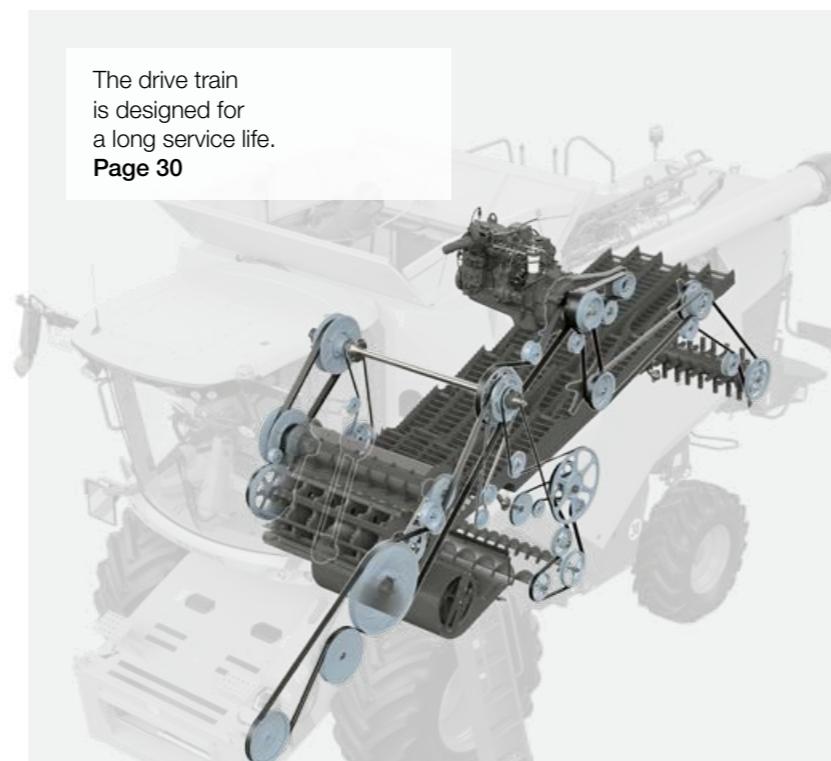
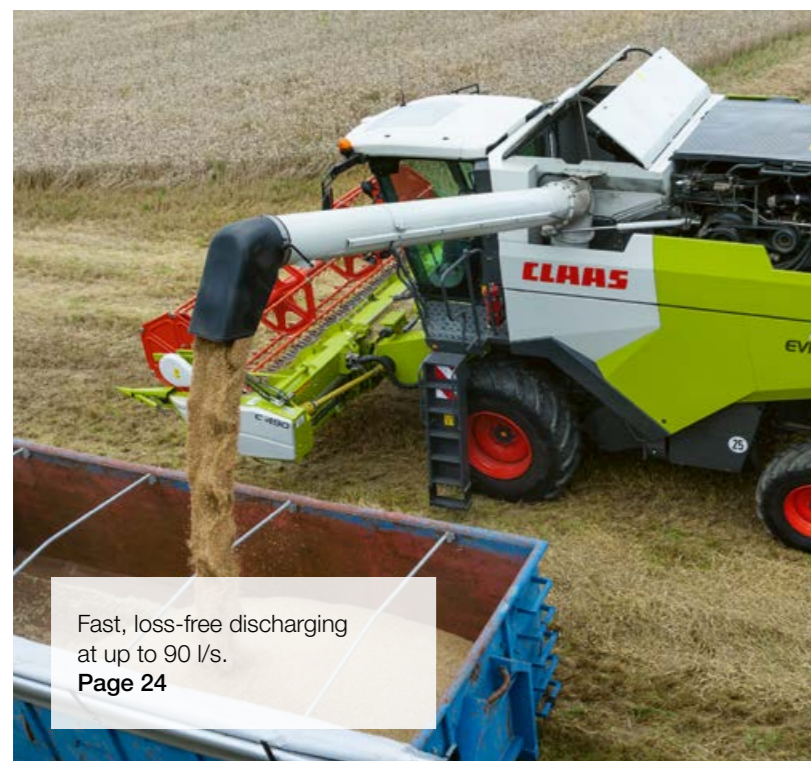

**Built to last.**

When the EVION joins your family, it's for the long term because it brings with it something from ours: the proven technology of its big brothers, the LEXION and TRION. This ensures that you can count on the EVION for generations and benefit from its performance every minute you are using it.

**Dependability for peace of mind.**

- CLAAS quality is your guarantee of a long service life and high resale value
- The large CLAAS service network is available 24/7 to supply you with parts which are a perfect fit for your machine and high-quality consumables
- MAXI CARE maintenance contracts keep the repair and breakdown risk to a minimum
- You can benefit from high efficiency, stable throughput, low fuel consumption and low running costs throughout the life of your machine
- The high level of digitalisation enables optimal integration of the EVION in your farm's digital ecosystem



# A successful harvest begins with the front attachment.

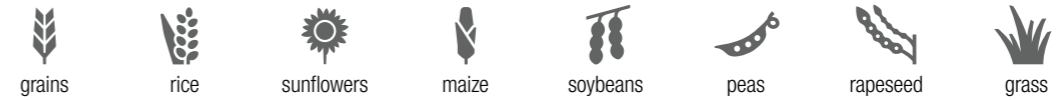

Effective and highly productive from the very first minute.

You can instinctively feel when the cutterbar is matched perfectly to the crop and the combine harvester. Harvesting becomes easier, faster and more convenient for all the family. Choose the cutterbar you need and your EVION will be ready to work effectively right from the start.

### Cutterbars for every crop.

Whether you are harvesting grain, such as wheat, rye, barley, oats and triticale or rapeseed, maize, sunflowers, rice, soybeans, flax, beans, lentils, millet, grass or clover – you can make full use of the performance potential of your EVION with the right front attachment from CLAAS.

### Automatic front attachment detection saves time.

The EVION configures the key parameters automatically. It does this based on the following information it receives from the front attachment module: cutterbar type, working width, number of sections, reel position, parking position and the AUTO CONTOUR set values for working height and hectare counter.

VARIO 680 / 620 / 560 / 500	
CERIO 680 / 620 / 560	
Standard cutterbars C 490 / C 430 / C 370	
Folding cutterbars C 540 / C 450	
MAXFLEX 680 / 620 / 560	
SUNSPEED 12-75 / 12-70 / 8-75 / 8-70	
CORIO 675 / 670 / 575 / 570	
SWATH UP 450	

### Short conversion times.

The EVION uses the same proven CLAAS front attachment interface as the LEXION and the TRION. Locking of both sides of the cutterbar is actuated from the left-hand side. Convenient multicouplers take care of all hydraulic and electrical connections. You are therefore able to benefit from short conversion times and can switch quickly from one field to the next. A rugged box to hold the rapeseed knives is available for the transport trailer.

### Universal feeder housing.

The universal feeder housing with three feeder chains is suitable for all cutterbars up to a working width of 6.80 m or for maize pickers up to 6 rows. Two lowering speeds allow you to position the front attachment precisely. Cutterbar and feeder housing are equipped with an automatic "soft start" system to reduce belt and drive wear. A slip clutch provides overload protection for the feeder housing.

### Protective reversing.

You can clear blockages in the feeder housing or front attachment by hydraulic reversing with high starting torque. This is actuated by means of an easily accessible switch on the armrest. The slow intake feeding after reversing avoids load peaks.



A powerful feeder unit makes you more productive.

- CLAAS has front attachments that precisely match your requirements
- The proven interface used in the LEXION and TRION also simplifies attachment and removal for the EVION
- Short conversion times let you switch quickly from one field to the next
- AUTO CONTOUR (BUSINESS equipment package) adjusts every cutterbar to the terrain precisely

### AUTO CONTOUR in the BUSINESS equipment package.

AUTO CONTOUR increases the output of your EVION and makes it even more cost-effective. The system automatically compensates for ground undulations parallel and transverse to the direction of travel. The required cutting height is programmed via CEMIS 700. AUTO CONTOUR then adjusts the active cutting height to the ground conditions. You are able to override both the lateral and the longitudinal control manually at any time.

### Let us take a weight off your mind.

You benefit from AUTO CONTOUR in particular at night, in laid crops, on side slopes and on stony ground. Another advantage of the system is that it damps and protects your front attachment.

### B CONTOUR in the TREND equipment package.

Cutterbars which are operated with CONTOUR automatically adjust to ground undulations parallel to the direction of travel. You only have to set the required cutting height in CEMIS and everything else is taken care of by CONTOUR. The system uses the signals from the sensor bands on the front attachment for active control of the cutting height. As with AUTO CONTOUR, you can override the automatic longitudinal control manually at any time.

### T

Choose the right front attachment.  
[combine-front-attachments.claas.com](http://combine-front-attachments.claas.com)

Scan me.



# Because families need all-rounders.

## High throughput in all crop types.

There isn't usually room for specialists in a family. Instead, everyone gets involved and helps wherever necessary. As soon as there is a job to be done, it's time to roll your sleeves up without thinking twice. The EVION fits into this kind of team perfectly. It impresses in every crop with stable throughput, even under difficult threshing conditions.

### One for all.

You can match the crop flow systems of the EVION precisely to the profile of your farm and crops. You benefit from large threshing and separation areas which ensure efficient campaign performance throughout the whole harvest season.

- The threshing concave with integrated hydraulic overload protection is a MULTICROP unit which has what it takes to cope with any crop
- AUTO CROP FLOW (automatic crop flow monitoring) protects the drive train
- AUTO SLOPE adjusts the fan speed automatically and provides stable cleaning performance on slopes
- The QUANTIMETER determines the yield and the grain moisture quickly and accurately
- Thanks to precise loss sensors you are always able to harvest at the machine's performance limit
- A grain tank capacity of up to 8,000 l and an unloading rate of 90 l/s make the process of collecting your grain particularly efficient
- The chaff spreader distributes the chaff precisely across the entire working width



Benefit from a straight, fast crop flow.



Scan me.



# Your grain deserves the best treatment.

## Large threshing concave area.

The threshing unit of the EVION is your guarantee of powerful threshing and separation performance throughout the entire harvest. Quality is improved significantly by subjecting the grain to a threshing action which is more abrasive than percussive. Straw and grain are also treated protectively even at very high throughputs or under extreme conditions – when straw is dry and brittle, for example.

### Protective threshing.

Measuring 600 mm in diameter and 1,420 mm in width, the threshing drum with its eight rasp bars has already proved itself in the TRION 500 and 700. Suitable for any crop, the drum has a protective threshing action which guarantees high-quality grain and straw, regardless of the type of crop you are harvesting with the EVION. Another benefit is the high separation performance which increases the efficiency of your campaign to a significant degree.

### Even crop flow.

If you adjust the threshing drum speed, the speed of the straw impeller is automatically adjusted accordingly. This makes for an even crop flow. Similarly, if you have to run more slowly under dry conditions or because of large grains, the straw impeller will also reduce in speed. This protects the grains and straw, the risk of broken grains is reduced and the structure of the straw is preserved.



## Grain and straw at their best.

- The threshing concave with integrated hydraulic overload protection is a MULTICROP unit
- The 600 mm threshing drum with the straw impeller running synchronously protects your grains
- AUTO CROP FLOW monitors the drive train

### Less downtime.

In order to avoid downtime due to blockages, damage or overload, AUTO CROP FLOW continuously monitors the speeds of the threshing unit, straw chopper and engine. If the preset slip limit is overshot or if the straw blockage flap reports a blockage, the system takes protective measures to prevent any more material from entering the machine.

### Reliable protection.

If, after the automatic shutdown, you do not eliminate the blockage or the cause of the stoppage, AUTO CROP FLOW reacts immediately. As soon as one of the monitored drives fails to turn, a reliable switch-on inhibitor prevents the threshing unit from being switched on again. This protects the drive components and prevents operating errors.



### 1 Threshing drum

Suitable for use with any crop, the threshing drum handles straw and grain extremely gently, even at high throughput rates.

### 2 Impeller

This feeds the harvested material evenly to the straw walkers. The speed is synchronous with the threshing drum.

### 3 Concave adjustment

Infinitely variable hydraulic adjustment of the position of the threshing concave is performed in CEMIS 700.

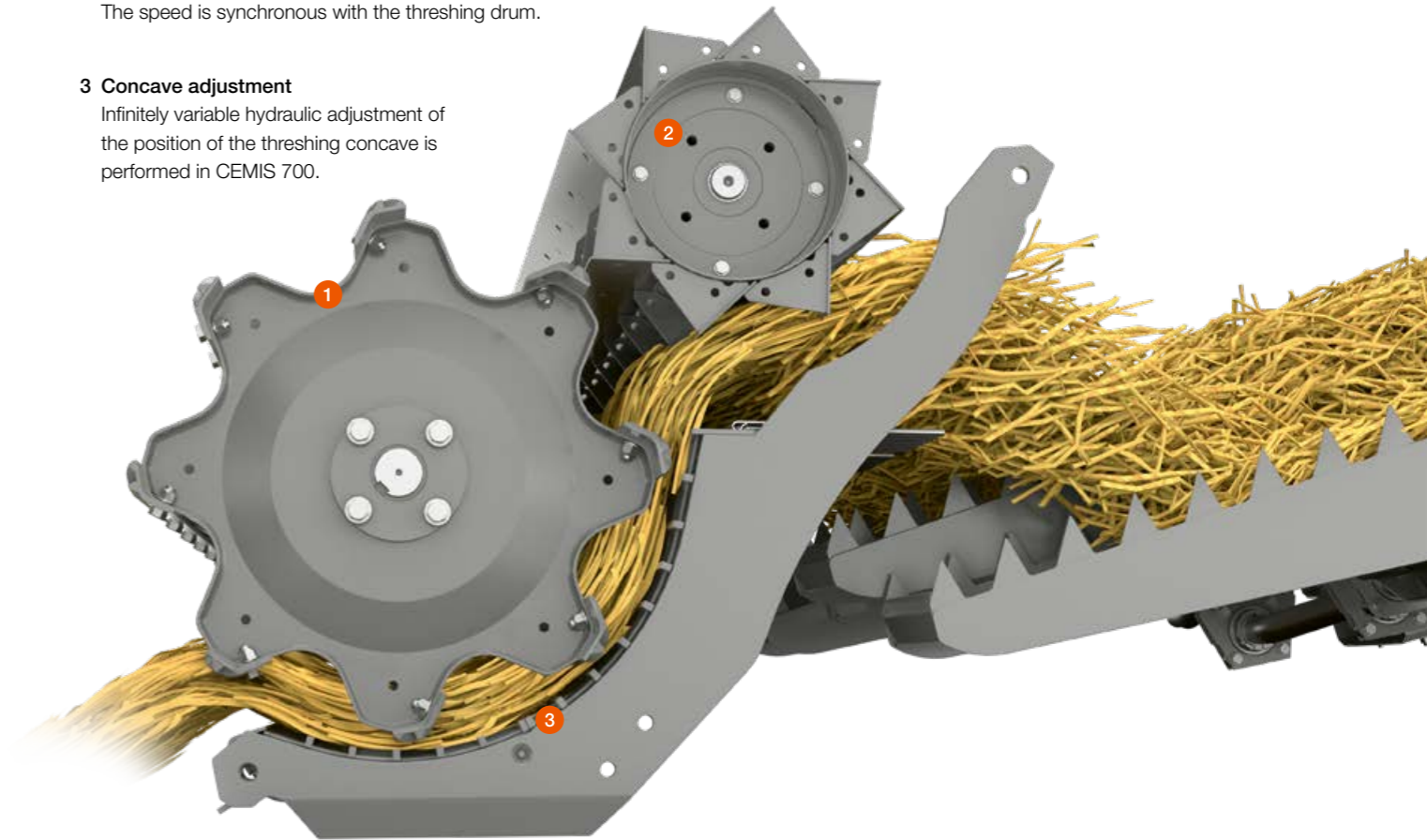

### Adjust threshing concave hydraulically.

Infinitely variable hydraulic adjustment of the position of the threshing concave can be performed from the comfort of the cab using CEMIS or direct adjustment (on the armrest). This is accompanied by parallel adjustment of the threshing drum concave clearance. In this way, you can be certain that the entire crop flow will run evenly while handling the straw gently. Integrated overload protection prevents blockages and protects the threshing unit from damage.

### Remove stones quickly.

Stones and other foreign objects are separated in the crop flow and collected in a large stone trap. Emptying this is simply a matter of pulling a lever and opening the flap. The system provides the combine harvester with reliable protection against damage. As a result, you can always operate your EVION up to its performance limits.

### Adjusting threshing concave flaps.

You can quickly adjust the threshing concave for different crops. The threshing concave flaps in the front area can be operated manually from outside. Below the threshing concave are plates which deawn and decorticate the grain. These can be engaged without tools by operating a lever. All EVION models are equipped with this feature which ensures protective threshing under dry conditions.





Change crop types in next to no time.

**EVION MAXI for all crop types.**

If your family farm has to harvest many different crops, the EVION MAXI is the perfect choice. Its exceptional flexibility allows you to harvest even more economically. You can quickly convert the threshing unit for maize, sunflowers or soybeans and easily adjust it to the different harvesting conditions.

**EVION CLASSIC for grain.**

The EVION CLASSIC is the ideal machine when grain is the focus of your harvesting activity. With just its standard universal equipment and the 7/18 concave segment, it is able to deliver high performance in all grain types. Additional threshing concave variants are available from CLAAS Service & Parts.

All EVION models can be retrofitted flexibly with options to meet specific requirements.

**Replaceable concave segment. In MAXI models.**



One of the factors responsible for the multicrop capability of the EVION MAXI is the replaceable concave segment. As this can be swapped out easily through the stone trap, there is no need to remove the feeder housing. This convenient changeover procedure saves you a lot of time.

The machine is supplied ex factory with a 7/18 concave segment with 7 mm wire spacing at the front and 18 mm at the rear. A round steel concave is also available from CLAAS Service & Parts.



Threshing drum drive with two speed ranges which can be configured easily.



**Two-stage threshing drum drive. In MAXI models.**





Another characteristic of the EVION MAXI which enables time-saving crop type changes is the ability to switch between the two speed ranges simply by repositioning a belt. In this way, the machine can be made ready quickly for optimal threshing of a wide range of crops. Whether you are harvesting maize, sunflowers, beans, peas or soybeans, you can always count on excellent results.

**Compatible cutterbars.**

A diverse crop rotation offers many options for the future for your family farm. CLAAS has a wide range of front attachments to enable you to harvest every crop effectively and productively the moment the time is right. Our line-up allows you to find the ideal solution to meet your requirements and benefit from the full productivity of the EVION.



The concave segment can be pulled out easily through the stone trap.

Models	MAXI 	CLASSIC 
Threshing concave	MULTICROP concave segment can be swapped out	Universal Grain one-piece concave
Threshing drum drive	220-630 / 415-1150	480-1150
Front attachment drive	M, grain up to 6.8 m, maize picker up to 6 rows	S, grain up to 6.8 m

**Automatic machine setup.**

In all EVION models, the basic settings for the different crop types are stored in CEMIS 700. Using the touch screen, you can call up the optimal start settings for the threshing unit and cleaning system and load them immediately. Changing over to a different crop type is just as convenient. A tap on the screen and the machine is automatically configured for the new scenario. This saves you a great deal of time during harvesting and allows you to avoid serious configuration errors right from the start.



Don't waste a single grain.



Benefit from a straight, fast crop flow.



Effective straw walker technology.

Every grain counts. The cleaner it is, the higher the revenue you can achieve. The EVION is in its element here. Both its straw walker area and the cleaning area are unsurpassed in this market segment. Practically all the residual grains are separated reliably and cleaned efficiently.

**Five long straw walkers make the most of your crop.** Five closed-bottomed straw walkers, each of which has four steps and a length of 4.40 m, feed the residual grains to the preparation floor. Cleaning the walker is fast thanks to maintenance openings which can be accessed easily without tools.

Two sensors reliably measure straw walker performance. AUTO CROP FLOW continuously monitors the crop flow on the walkers.

**AUTO SLOPE manages cleaning on slopes.** Hilly fields are a challenge for the grain cleaning system. Uphill, the fan speed has to be reduced, downhill it has to be increased. AUTO SLOPE reduces your workload by controlling the fan speed on the basis of the longitudinal tilt.

This ensures that the cleaning performance always remains stable and the crop flow in the cleaning system is maintained. In this way, you are able to increase throughput and reduce grain losses on slopes.

**For particularly light crops.** As grass seeds and small seeds are very light, it is important to adjust the fan speed in order to keep losses to a minimum. A retrofit kit is available to reduce the fan speed for such situations.

- 1 Threshing system**  
The threshing unit of the EVION guarantees powerful threshing and separation performance throughout the entire harvest.
- 2 Straw walkers**  
Five long straw walkers, each with four steps, ensure effective residual grain separation and provide the largest separation area in this combine harvester segment.
- 3 Preparation floor**  
Increases the cleaning capacity of the EVION and simultaneously reduces the load on the upper sieve. Grain and non-grain constituents, such as chaff, straw and ear tips are pre-sorted. The light plastic preparation floor elements can be removed to the front for cleaning.
- 4 Radial fan**  
The speed of the radial fan with a hydraulic variator is adjusted via the CEMIS control terminal or by means of a direct switch on the armrest.
- 5 Step**  
Effective cleaning starts at the first step. The airflow causes initial separation of the constituents and reduces the load on the upper sieve.
- 6 3D cleaning system**  
The maintenance-free system operates in the background. Using active transverse control, it distributes the material evenly across the upper sieve. This ensures that the cleaning performance remains stable when operating on slopes.
- 7 Upper and lower sieve**  
A number of upper and lower sieve variants are available. As with the TRION and LEXION, all of them can be adjusted electrically.
- 8 Returns**  
Ear parts which have not been threshed completely are fed back to the threshing drum here.
- 9 Cleaning throughput monitor**  
Sensors in the cleaning system detect losses. The values displayed in CEMIS 700 provide the operator with important information about the machine settings.
- 10 Straw walker throughput control unit**  
The straw walkers are equipped with sensors which detect the straw walker losses and enable rapid assessment of the machine settings.
- 11 Chopper**  
The chopper delivers very short-chopped straw and promotes sustainable tillage.





# Crop collection you can count on.

## Fast collection.

The EVION has been designed to make collecting your grain as fast and reliable as possible. You can empty the high-capacity grain tank in no more than 90 seconds. The grain tank unloading tube concentrates the stream of material precisely and prevents run-on losses. Throughout the entire discharging process you have an optimal view of your transport vehicles, including via a camera, which makes loading taller vehicles a great deal easier.

## Space for up to 8,000 litres of grain.

Once the threshing unit, secondary separation and cleaning systems have done their work, the cleaned grain is collected in the grain tank which has a capacity of up to 8,000 l and an unloading rate of up to 90 l/s. A large grain tank inspection window allows you to monitor the quality of the crop.

## The right size for every farm.

- EVION 450 with 8,000 l, deploys at the touch of a button
- EVION 430 with 6,500 l, deploys at the touch of a button
- EVION 410 with 5,600 l grain tank capacity, deploys manually

## Unload precisely and without any losses.

The pivot angle of 105° allows you an excellent view of the grain tank unloading tube. The square spout concentrates the stream of material so that you can also fill low vehicles precisely and without any losses. An anti-dribble flap at the end of the grain tank unloading tube prevents run-on losses.

All three grain tank unloading tubes can be equipped with a pivoting spout as an option. It is adjusted via the CMOTION multifunction control lever and simplifies the loading of the trailer.

## Reliable yield data for you to evaluate.

The primary functions of the QUANTIMETER are throughput measurement, moisture content measurement and data display in CEMIS 700. The moisture content of the crop is monitored continuously and displayed on demand. During the volume measurement in the grain elevator, a photo cell records the filling of the individual paddles. Using appropriate correction factors, including the transverse and longitudinal tilt of the machine, the QUANTIMETER automatically determines the precise quantity harvested.

TELEMATICS transfers all the data straight to your farm management software. This information can be used for subsequent evaluation of the harvest and also provides you with a sound basis for well-founded yield mapping.

Equipment packages	BUSINESS <b>B</b>	TREND <b>T</b>
Chopper	SPECIAL CUT	STANDARD CUT
Static knife, engaged by lever	55	55
Chopper knives	72	52
Rasp bar, engaged by lever	standard	–

## SPECIAL CUT for short chopped material.

STANDARD CUT and SPECIAL CUT, respectively equipped with up to 52 and 72 knives sharpened on both sides as well as a mechanically adjustable static knife, provide the appropriate cutting action. The short lengths of cut produced by SPECIAL CUT are ideal for subsequent minimum cultivation of your soil.

## Deflector spreader up to 6.80 m working width.

You do not need tools to adjust the deflector spreader. The spreading width and direction are very easy to adjust manually.

## Even chaff distribution.

The chaff spreader distributes the sieve pan residue evenly across the entire working width. Lost grains and weed seeds germinate uniformly and can therefore be dealt with more effectively later on. The chaff spreader can be pivoted for very easy access to the sieve pan.

## Loose swath.

The swath formers of the EVION produce a loose, well-aired swath which promotes faster and more even drying of the straw. Another characteristic of the swath formers is that they ensure the swath does not lie in the machine's tracks. This and the compact form of the swath enable the subsequent straw collection to be performed without losses.





Because everyone in the family rolls their sleeves up.

Interplay of optimal components.

Top performance is the result of all the parts of your CLAAS machine being precisely matched to each other and working together optimally. CLAAS POWER SYSTEMS brings together the best components to form an intelligent drive system: drives which are suited to your requirements and the way you use your machines; full engine output only when you require it; fuel-saving technology which quickly pays off.

**The EVION pulls its weight.**

The powerful Cummins engine delivers exactly the power you need. The DYNAMIC POWER intelligent engine management system is standard on all machines and reduces your fuel consumption by up to 10%.

- The 6.7-litre Cummins engine is notable for its high torque and efficient power transmission
- DYNAMIC POWER reduces your fuel consumption by up to 10%
- The 500-litre fuel tank saves you the trouble of refuelling during long harvesting days
- The low rated engine speed of 1,900 rpm saves fuel and reduces the noise level during harvesting and on the road
- The top speed of 30 km/h enables fast transfers
- The differential lock ensures that you can make progress reliably in challenging terrain and on slopes
- Tyres with a diameter of 1.85 m at the front and up to 1.50 m at the rear protect the soil and allow high straw swathes to be crossed without difficulty





# It uses its power intelligently.

You consume less costly fuel.

All the machines in the EVION family are equipped with DYNAMIC POWER as standard. This system automatically adjusts the engine output to the operating conditions. When the machine is operating in the partial load range – during swathing, for example – you can achieve fuel savings of up to 10%. At full load – when you are unloading the grain tank while the straw chopper is activated, for example – the engine output is automatically maintained at the maximum level.

### Cummins engines with Stage V and Tier 3.

With an annual output of more than 1.4 million engines, Cummins is the world's largest independent engine manufacturer. Around the world, more than 1,000,000 agricultural machines use Cummins engines with outputs ranging from 55 to 4,400 hp.

The EVION combine harvesters are equipped with 6.7-litre Cummins engines. These powerful units meet the Stage V/ Tier 3 emission standard and are notable for their high torque and efficient power transmission.

- 6-cylinder in-line layout with 6.7 l displacement
- Maximum output 190 kW / 258 hp
- Common rail technology
- Exhaust gas aftertreatment with AdBlue (Stage V)

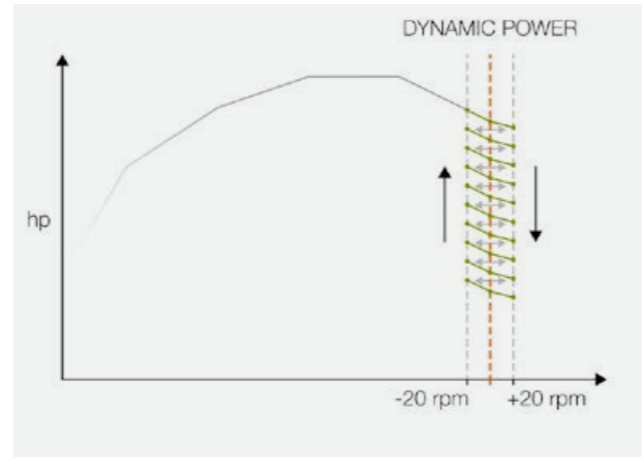

### Pleasantly quiet in the field and on the road.

The Cummins powerplant delivers its maximum output at a rated speed of just 1,900 rpm (2,100 rpm in Tier 3). On the road, its speed adjusts automatically to the ground speed. This means that you save significantly more fuel while benefiting from quieter running and, as a result, greater driving comfort. The idling speed of 800 rpm also makes for pleasantly quiet operation when attaching the cutterbar or queuing in traffic.

- Reduced rated speed:  
1,900 rpm (Stage V) or 2,100 rpm (Tier 3)
- Idling speed when no hydraulic function is in use: 800 rpm
- Idling speed (in standby mode): 1,200 rpm

### Extended operation without the need to refuel.

The high-capacity fuel and urea tanks (Stage V) are particularly safe and robust. They are both located in the same position on the right-hand side of the machine for convenient filling with diesel fuel and urea.

- Fuel tank with 500 l capacity
- Urea tank with 80 l capacity (Stage V)
- Fewer refuelling stops during the harvest



Cummins engine with AdBlue exhaust gas aftertreatment (Stage V)



### Clean air with low dust content cools more effectively.

The EVION draws in outside air for the cooling system through the rotating radiator screen. As the air intake area is actively cleaned continuously, less dirt accumulates on the cooling fins. This reduces the overall dust load in the cooling system, thereby increasing the cooling performance.

### Clean machines work more efficiently.

All EVION MAXI models (Stage V and Tier 3) are equipped with an air compressor. Connection points next to the cab door, in the engine compartment and by the left rear wheel make it easy to reach all the places that need to be cleaned quickly after work. An easily accessible air gun and hose are carried on the machine. No other accessories are required.

As much power as necessary, as little fuel as possible.

- High-torque Cummins engines of the latest generation meet the Stage V emission standard
- DYNAMIC POWER saves up to 10% of fuel
- The engine speed is reduced during road travel
- The lower idling speed reduces noise
- When the grain tank unloading function is activated, the full engine output is enabled automatically to ensure stable throughput
- The integrated air compressor allows cleaning to be carried out quickly while out in the field



# A drive you can count on throughout the life of your machine.

## Hydrostatic ground drive up to 30 km/h.

Regardless of which member of your family is at the wheel of the EVION, it will always be operating productively. All models are equipped with a rugged, 3-speed hydrostatic ground drive with convenient gear selection via a shift lever. Handling is as smooth as that of the LEXION or TRION. The high efficiency of the hydrostatic motor saves power which is available to the rest of the machine.

## Comfortable, fast and quiet.

- The engine speed adjusts automatically to the speed or the tractive force required
- At a rated speed of just 1,900 rpm (Stage V) or 2,100 rpm (Tier 3), you can travel at up to 30 km/h while saving on fuel
- Transfer from one field to the next quickly, in comfort and with a low noise level
- When waiting at traffic lights with the control lever in the neutral position, the engine speed is reduced to 1,200 rpm
- Less wear of the drive components leads to lower maintenance costs

## Tyres that help protect the soil.

With its 800 mm wide tyres, the EVION exerts only slight ground pressure. Even on wet soil, it does not leave any deep tyre tracks and so reduces undesirable soil compaction. The machine's external width of 3.50 m makes it compact on the road. This is particularly welcome when negotiating narrow roads or field tracks. The tyre diameters of 1.85 m at the front and 1.35 m or 1.5 m at the rear provide plenty of traction with a low power requirement. The wide contact areas make for safe, reliable operation, whatever the task, while the high ground clearance allows the machine to drive over even large straw swaths.

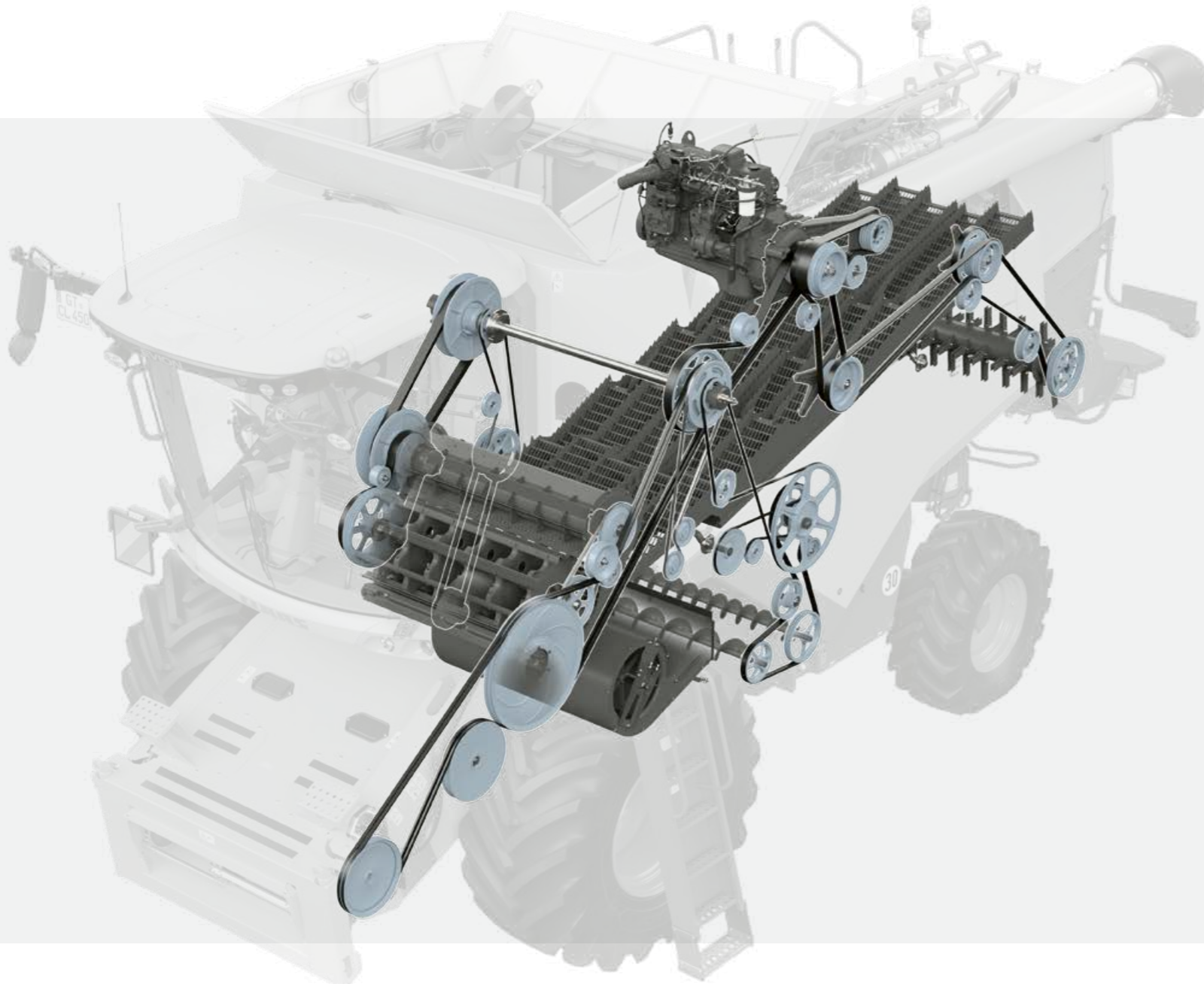

## Durable drive concept.

Power transmission is performed efficiently via belt drives. The drives engage smoothly with low wear. All the drive components are designed for a long service life.

- Many components have already proven themselves in the LEXION and TRION
- The drives are engaged electrohydraulically at the touch of a button
- In order to reduce load peaks, the threshing unit and straw chopper are engaged sequentially
- The front attachment can be activated at full load
- The hydraulic threshing unit variator and the hydraulic fan variator enable precise speed adjustment and a long service life

## Electrohydraulic differential lock.

### In MAXI models.



The electrohydraulic differential lock, which is activated by means of a pushbutton on the control panel, ensures that you can continue to operate safely and reliably in extreme conditions. The high traction and pulling power are maintained on slopes and in the wet.

- Engaged manually, remains active until:
  - Automatic disengagement
  - on selection of 3rd gear
  - on actuation of the road travel switch
  - on actuation of the foot brake



# Because harvesting needs to be convenient to be successful.

The greater the comfort,  
the higher the productivity.

On long harvesting days, every member of the family has to play their part – and none more so than the EVION. With its spacious cab, high standard of comfort and low noise level, it provides an ideal working environment out in the field. Intelligent operator assistance systems take care of much of your workload while you benefit from the excellent view of the front attachment thanks to the narrow cab pillars. When harvesting continues after dark, the working area is illuminated bright as day by LED headlights.

### An EVION simply makes sense.

The control concept of the EVION is so easy to understand that even inexperienced operators are able to master the machine in a short time. The bright, high-resolution CEMIS 700 display tells them what they need to know at a glance and is easy to navigate via the touchscreen or rotary pushbutton control.

- The multifunction armrest moves with the seat and places all the key machine functions comfortably within reach of your right hand
- Direct adjustment switches provide quick access to a set of basic functions
- The direct view into the returns and grain tank makes it easy to monitor the crop
- You can adjust the CEMIS 700 terminal and the armrest to the most comfortable position for you
- The optional footrests enable a relaxed sitting position
- A perfect cab climate – which even extends to the storage compartment in the roof – is provided by the automatic air conditioning
- The control panel for the work lights can be operated intuitively
- Camera systems give you a clear view for added safety and convenience when performing tasks such as unloading the grain tank or hitching up the cutterbar trailer





# Long harvesting days feel shorter.

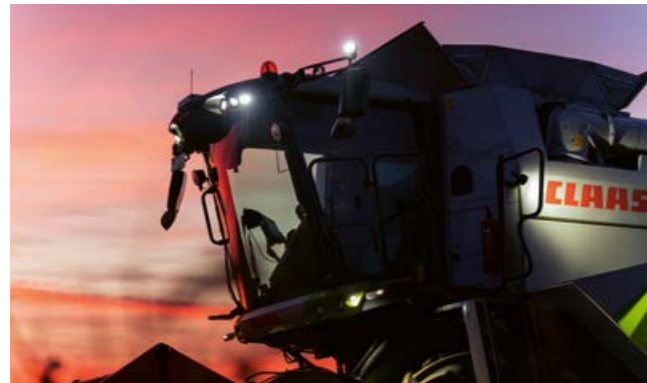

## Make yourself at home.

The EVION comes with many of the characteristics which have long been firm favourites with operators of its big brothers, the LEXION and TRION. There is the incomparable CLAAS comfort and convenience, for example, or the intelligent control concept which gives you easy access to all machine functions. The machine is so easy to control that anyone can operate it, even under challenging conditions.

## LED lighting packages bring light into every corner.

The front attachment is brightly illuminated, just like the areas to the front and sides as well the stubble. As a result, you can keep an eye on everything, even on long days or during maize harvesting. All the key machine components are equipped with maintenance lighting.



### 1 Bright CEMIS 700 terminal

The ISOBUS-compatible CEMIS 700 terminal keeps you informed about all key machine parameters at a glance.

### 2 Armrest moves with the seat

Your right hand intuitively controls all the important machine functions by direct adjustment.

### 3 Individual adjustment

You can adjust the CEMIS 700 terminal to the position that suits you best.

### 4 More legroom

The narrow steering column and the convenient footrests mean that even tall operators can find the ideal, comfortable working position.

### 5 Comfortable seats

The air-suspended operator's seat and a comfortable instructor's seat look after your back, even on long working days.

### 6 Good all-round view

Cantilever mirror arms and narrow cab pillars allow a clear view to all sides.

### 7 Easy returns monitoring

The direct view into the returns allows you to assess the machine settings quickly.

### 8 Large grain tank inspection window

For even easier crop monitoring.

### 9 Pleasant temperature

The standard-fit automatic air conditioning provides a comfortable working temperature, whether the day is hot or cold.

### 10 Powerful LED lighting package

Benefit from 360° illumination of your working area with LED work lights.

### 11 Everything in its place

With your charging cable plugged in safely out of the way, your phone or tablet is ideally positioned for use without compromising your view or your access to the controls.

Equipment packages	BUSINESS <b>B</b>	TREND <b>T</b>
Terminal	CEMIS 700	CEMIS 700
Operator's seat	comfort seat, air-suspended	comfort seat, air-suspended
Instructor's seat	including refrigerator box	including storage compartment
Rear-view mirrors	electrically adjustable	manually adjustable
Work lights	LED – Plus	LED
Footrests	standard	retrofitable



Everyone can drive the EVION.



**1 CEMIS 700 touchscreen**

CEMIS 700 responds immediately to a tap on the touchscreen. You have direct access to the field work and road travel machine functions.

**2 Soft buttons**

Simply select the required menu or function represented by the self-explanatory symbols on the display.

**3 CEMIS 700 rotary/push switch**

Even when operating in bumpy terrain in the field, you can easily navigate the CEMIS 700 menu by using the rotary/push switch and the escape key.

**4 Favourites management**

The control panel on the armrest or the buttons on the CMOTION multifunction lever make it easy for you to call up ten favourite adjustable settings which you have predefined. You therefore always have direct access to important functions and can change them quickly.

**Integrated camera display.**

With its wide viewing angle, the rear camera covers a large area behind the machine. The camera image is displayed on the CEMIS 700 terminal. Full-screen mode is activated automatically as soon as you put the machine into reverse.

- You benefit from a commanding view and a high level of safety when manoeuvring
- You can monitor swathing or the distribution of chopped material more easily in full-screen mode



CEMIS 700 works intuitively.

The clearly laid-out harvest screen of the CEMIS 700 display shows you the most important parameters on the basis of a machine silhouette. Images from up to two cameras can also be shown. Additional features include a job management function for up to 20 jobs and a crop log with basic settings for 24 crop types.

When the combine harvesting season is over, you can use the 7" touchscreen terminal in your tractor to control the associated CLAAS implements.

**CEMOS Advisor supports you (A).**

CEMOS Advisor is available free of charge in CLAAS connect. Running on your smartphone, this app helps you find the best machine settings. The application, which is based on the CEMOS DIALOG logic, provides fast, straightforward support and includes a lost grain calculation function. You can enter a specific measurement area for loss analysis as well as entering losses by volume, weight or number of grains. This makes it much easier to monitor the performance of the machine settings.

Everyone quickly feels at home in the EVION.

- CEMIS 700 is easy to use in every harvesting situation
- The straightforward logic reduces the acclimatisation time for every operator
- You have a choice of three ways to adjust the settings of the EVION quickly and directly
- Being able to view the output of up to two cameras makes work safer and more convenient
- The integrated job management function precisely logs the key data of up to 20 jobs
- The crop log with basic settings for 24 crop types enables faster crop type changes
- You can transfer the ISOBUS-compatible CEMIS 700 terminal to other machines when the combine harvesting season is over



Helping each other  
is a family thing.



### Steering assistants for every requirement.

The EVION harvests accurately down to the last centimetre and so keeps the number of passes required to a minimum. You can equip it with two automatic steering systems which can be selected on the basis of your operational requirements: the digital AUTO PILOT and the satellite-based GPS PILOT CEMIS 1200.

#### GPS PILOT CEMIS 1200 is precise.

The satellite-based automatic steering system from CLAAS is permanently integrated in the machine. It supports you in all tasks which depend on high pass-to-pass accuracy. You start the GPS PILOT via the multifunction lever. It actively controls the steering hydraulics and takes you across the field, always on the right track, using the full working width with no overlapping and regardless of the light conditions. It works at night or in low visibility just as precisely as it does in full daylight. You receive correction signals for whichever degree of accuracy you require.

#### GPS PILOT CEMIS 1200 is user-friendly.

With the GPS PILOT automatic steering system, the EVION will seem like it is running on rails. It takes next to no time to become proficient in using the straightforward CEMIS 1200 touchscreen interface.

The high level of digitalisation enables optimal integration of the EVION in your farm's digital ecosystem. Thanks to ISOBUS and standard data exchange formats, CEMIS 1200 is the future of precision farming.

The GPS antenna and the terminal can be used throughout the year on all CLAAS machines set up for this equipment. Transferring the system from one machine to another takes next to no time – keeping you flexible and saving money.



With CEMIS 1200, all jobs can be created and managed directly on the machine.

#### CEMIS 1200 is the future.

With CEMIS 1200, you can perform your job management tasks with just a few clicks via a mobile phone connection. This standardised and convenient solution allows you to plan your jobs in 365FarmNet or other farm management systems and transfer them straight to the harvesting machine via TELEMATICS. The operator can keep track of all the jobs and the office receives fast and direct feedback of all the key figures.

Your EVION can be equipped with GPS PILOT CEMIS 1200 tailored to your farm and pre-installed with full functionality.

Or you can choose to build up the system gradually as your requirements grow. Thanks to its digital architecture, you can adapt its functionality quickly and flexibly to suit your needs. The appropriate licence or activation is transferred online straight to your terminal.

You can test additional functions and correction signals free of charge in advance.



Two sensor bands each scan a row of maize.

#### AUTO PILOT.

Two digital sensors incorporated in one of the picker units of the maize picker guide the EVION automatically through the rows of maize. The signals they generate are translated into corrective steering impulses. Twin-row sensing allows automatic steering in various row widths.

- The AUTO PILOT reduces the strain on you the whole time you are working
- You benefit from a higher area output
- Even when there are gaps in the crop, you can always count on reliable row guidance
- The maintenance-free and low-wear technology saves cash and valuable time during harvesting

#### Precision for every task.

- The GPS PILOT steers precisely and can be controlled intuitively via CEMIS 1200
- Changing the GPS antenna and CEMIS 1200 to another machine takes next to no time
- The AUTO PILOT helps you work precisely in maize



# A connected EVION is more productive.

## Digitalisation pays.

Intelligent digitalisation matched to the requirements of your farm reduces your workload and increases your productivity. Data generated in completely different places can be collected and evaluated centrally. This conserves your resources and improves your farm operations.

To enable you to get more out of the EVION and your other machines, CLAAS offers a range of modules which allow systems, technology and working processes to be connected with each other, regardless of the manufacturer.

### Forward planning in the office.

- Use 365FarmNet to determine the harvest sequence per crop on the basis of maturation
- Prepare jobs including reference tracks and transfer them to CEMIS 1200

### Optimisation on the machine.

- Create and manage all jobs directly on the machine with CEMIS 1200
- All job data are documented online as an automatic background operation
- Transmit data from different manufacturers' products into the cloud smoothly
- Use CLAAS connect and the CEMOS Advisor app to monitor the performance of the combine harvester and make full use of it
- Save valuable maintenance and service time with remote diagnostics

### Detailed assessment in the office.

- Transfer and document job and harvest data quickly
- Analyse fields easily and map yields precisely
- Assess work processes intensively and identify scope for improvement

### CLAAS connect links you up with CLAAS.

CLAAS connect links people, machines and systems. This app helps you keep track of your machine fleet, check the most important telemetry data and make use of CEMOS Advisor to optimise your combine harvester. You can find the right operator's manual quickly and view service and licence contracts. Lubricants and parts can be obtained conveniently by ordering them from the shop around the clock. What's more, you have access to many other CLAAS applications.

### Machine connect links your EVION into the network.

Machine connect allows you to use the full scope of CLAAS connect. It gives you a real-time overview of the tank fill levels, the location, the operating hours and maintenance dates. You also benefit from other digital CLAAS services, such as CLAAS TELEMATICS and MAXI CARE connect. With CEMIS 1200 and Machine connect you can take care of job management tasks on the machine itself and transfer the data online to TELEMATICS, 365FarmNet or other connected systems.

### TELEMATICS records your success.

Work data, tracks and yield data for your combine harvester can be retrieved and recorded continuously by means of TELEMATICS. All data are transmitted via the mobile phone network from the machine to the server, where they are processed and stored. You can access and evaluate your data online in real time or retrospectively via the TELEMATICS portal or the app.

DataConnect, developed by CLAAS, 365FarmNet, John Deere, Case, Steyr and New Holland, is the first direct multi-manufacturer and industry-wide open cloud-to-cloud solution. It allows you to control and monitor your entire machinery fleet in the CLAAS TELEMATICS portal.



### Connected documentation collects your harvest data.

With the "CLAAS Connected Documentation" licence, the harvest data associated with your combine harvester are automatically collected and assigned to the fields which have been worked. This functionality requires that your field boundaries are specified in the system, either before or after the harvest. Subsequent documentation of any extra areas which happen to be harvested means that no data are lost. Data can be exported to all the current farm management programs at any time.

### MAXI CARE connect simplifies servicing.

MAXI CARE connect plays an important role in ensuring the operational reliability of your machines. It simplifies maintenance and service support for you significantly. The machine informs the service partner of an upcoming requirement for maintenance or sends immediate notification if a fault arises. The service partner therefore has access to the relevant data and can prepare optimally for the intervention in both scenarios.





# Harvest time highlights the value of fast maintenance.

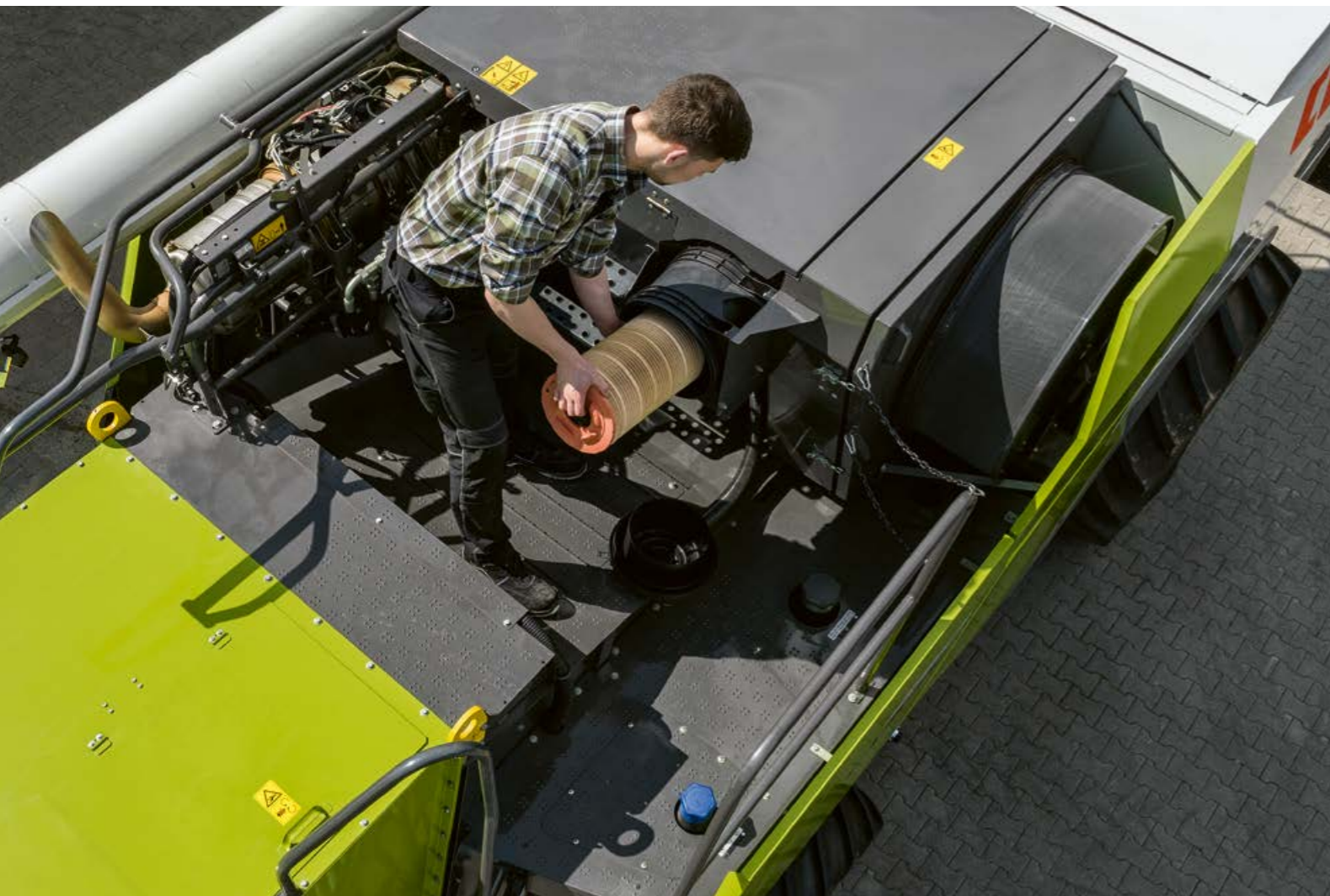

### Good accessibility.

The radiator and engine compartment are accessed conveniently via a platform. Components relevant to the crop flow, such as the sieve pan and straw walkers, are provided with easily accessible maintenance and inspection ports which make maintenance, care and cleaning of the machine significantly easier. Slip-resistant steps and a rail make for easy access to the grain tank and inspection window. Attachment points for the portable ladder are located around the whole machine. The exterior of the cab is equipped with steps and handles to allow you to clean the windows safely.

### Long lubrication intervals.

In contrast to many other machines, the EVION does not have a single lubrication point that needs to be regreased every day. The shortest lubrication interval is 50 operating hours. It is therefore quite sufficient to use the grease gun only once a week.

### Easy visual inspections.

When something is easy to find, it will be checked. All the maintenance and lubrication points are clearly visible and provided with stickers indicating their purpose and interval. An integrated display on the tensioners tells you about the belt tension. All oil levels can be read clearly via level gauges. The drain hoses for engine oil and hydraulic oil are routed centrally and can be accessed easily from ground level. The captive drain plugs cannot be lost.

### Clean hands.

There is no longer any need to worry about having dirty hands in the cab. Immediately next to the tool compartment is a 20-litre water tank with an integrated soap dispenser. As it can be used without having to open, and subsequently close, any side panels, your hands remain clean after washing. The tank can be removed easily for filling.

## Every minute is precious.

The EVION is a member of the CLAAS combine harvester family which has always been known for its modest maintenance requirements. It shares its well thought-out maintenance and accessibility characteristics with the LEXION and TRION.

As on the large machines, all the maintenance points of the EVION are positioned logically, clearly indicated and easily accessible. Thanks to this user-friendly design, maintenance tasks are completed quickly, allowing you to use your time more effectively in the field.

### You save a lot of time.

- You are able to complete the daily maintenance tasks quickly and conveniently; all the maintenance points are easily accessible
- Reduces time spent with the grease gun; the shortest maintenance interval is 50 operating hours
- The bright maintenance lighting allows you to work safely, even after dark
- Remote Service ensures maintenance is performed exactly when it is due
- The air compressor enables cleaning to be performed quickly while out in the field



Maintenance openings at the end of the straw walkers provide fast access without tools.



20 litres of water and a soap dispenser are available for hand washing when work is over.



All lubrication points are combined and clearly indicated in grease anchor blocks.



# Whatever it takes – CLAAS Service & Parts.



CLAAS Service & Parts  
is there for you, 24/7.  
[service.claas.com](http://service.claas.com)

Scan me.



### CLAAS service contracts.

Few factors are as decisive for the success of your business as the reliability of your machines. This is why we offer services for your machine which ensure a high degree of reliability at rates which allow you to budget precisely.

### MAXI CARE connect.

With MAXI CARE connect, all the relevant data from your telematics-equipped machines are made available to your service partner. This greatly simplifies the remote diagnostic process and the provision of remote support. Servicing can be carried out more efficiently and the level of machine readiness for use is enhanced. All you have to do is give your consent.

The availability of products from CLAAS Service & Parts may vary according to country.



### Specially matched to your machine.

Precision-manufactured parts, high-quality consumables and useful accessories. Choose our comprehensive product range to be certain of receiving exactly the right solution to ensure 100% operating reliability for your machine.



### For your farm: CLAAS FARM PARTS.

CLAAS FARM PARTS offers one of the most comprehensive ranges of multi-brand parts and accessories for all agricultural applications on your farm.



### Global supply.

The CLAAS Parts Logistics Center in Hamm, Germany, stocks almost 200,000 different parts and has a warehouse area of over 183,000 m<sup>2</sup>. This central spare parts warehouse delivers all ORIGINAL parts quickly and reliably all over the world.



### Your local CLAAS distributor.

Wherever you are, you can count on us to always provide you with the service and the contact persons you need. Your CLAAS partners are on hand in your local area, ready to support you and your machine around the clock. With know-how, experience, commitment and the best technical equipment. Whatever it takes.



It's a winner  
with the whole family.



Because of its convenience.

- The CMOTION multifunction lever and the CEMIS 700 terminal are extremely easy to operate
- The LED work lights and the high level of cab comfort make work less of a strain
- Excellent accessibility makes it extremely easy for any user to perform maintenance tasks and machine adjustments
- The direct view into the returns and grain tank makes it even easier for you to monitor the crop
- CEMIS 1200 (optional) provides support for GPS tracking and documentation

Because of its flexibility.

- Short changeover times mean that you can switch from one crop to another in next to no time
- The MULTICROP threshing concave has what it takes to cope with any crop
- The universal threshing drum handles straw and grain gently, even at high throughput rates
- The differential lock ensures that you can make progress reliably in challenging terrain and on slopes
- AUTO SLOPE adjusts the fan speed automatically and delivers full cleaning performance on slopes

Because of its reassuring dependability.

- CLAAS quality guarantees a long service life and high resale value
- The large CLAAS service network is available 24/7 to supply you with parts which are a perfect fit for your machine
- MAXI CARE maintenance contracts keep the repair and breakdown risk to a minimum
- You can benefit from high efficiency, stable throughput, low fuel consumption and low running costs throughout the life of your machine
- The high level of digitalisation enables optimal integration of the EVION in your farm's digital ecosystem

EVION		450	430	410
<b>Threshing unit and primary separation</b>				
Conventional threshing system		●	●	●
Threshing drum width	mm	1420	1420	1420
Threshing drum diameter	mm	600	600	600
Threshing drum speed	rpm	480-1150	480-1150	480-1150
With reduction gear	rpm	220-630 / 415-1150	220-630 / 415-1150	—
As retrofit set	rpm	420-1080	420-1080	420-1080
Threshing concave wrap angle	degrees	121	121	121
Main concave area	m <sup>2</sup>	0.95	0.95	0.95
<b>Secondary separation</b>				
Straw walkers	No.	5	5	5
Straw walker length	mm	4400	4400	4400
Total secondary separation area	m <sup>2</sup>	6.25	6.25	6.25
<b>Crop cleaning</b>				
Radial fan		●	●	●
Fan adjustment, hydraulic		●	●	●
3D cleaning system		○	○	○
Total sieve area	m <sup>2</sup>	4.80	4.80	4.80
Electric sieve adjustment		●	●	●
<b>Grain tank</b>				
Capacity (as per ANSI/ASAE S312.2)	l	8000	6500	5600
Unloading auger swivel angle	degrees	105	105	105
Pivoting unloading tube spout		○	○	○
Unloading rate	l/s	90	90	90
QUANTIMETER yield and moisture measurement unit		○	○	○
<b>Chopper</b>				
SPECIAL CUT straw chopper, knives	No.	72	72	72
STANDARD CUT straw chopper, knives	No.	52	52	52
Chaff spreader		○	○	○
<b>Chassis</b>				
3-speed manual gearbox		●	●	●
30 km/h		○	○	○
Differential lock		○	○	—
Car-like driving characteristics		●	●	●
<b>Engine</b>				
Manufacturer / Stage V type		Cummins B6.7	Cummins B6.7	Cummins B6.7
Manufacturer / Tier 3 type		Cummins QSB6.7	Cummins QSB6.7	Cummins QSB6.7
Cylinders / displacement	No. / l	6 / 6.7	6 / 6.7	6 / 6.7
Maximum output (ECE R 120)	kW/hp	190 / 258	170 / 231	150 / 205
Fuel consumption measurement		●	●	●
Fuel tank capacity	l	500	500	500
Urea tank capacity, Stage V only		80	80	80
DYNAMIC POWER		●	●	●
Air compressor		○	○	○
<b>Cab</b>				
CEMIS 700		●	●	●
CMOTION multi function lever		●	●	●
Automatic climate control		●	●	●
Operator's seat, air-suspended		●	●	●
LED work lights		●	●	●

EVION		450	430	410
<b>Data management</b>				
TELEMATICS		○	○	○
Job management		○	○	○
Yield mapping		○	○	○
MAXI CARE connect		○	○	○
<b>Operator assistance systems</b>				
AUTO SLOPE		○	○	○
AUTO CROP FLOW		○	○	○
<b>Steering systems</b>				
GPS PILOT CEMIS 1200, AUTO PILOT		○	○	○
Weights (can vary depending on equipment) without front attachment, straw chopper and chaff spreader, full fuel tank, full urea tank	kg	11500	11500	11500

EVION		450	430	410
<b>Tyres on drive axle</b>				
<b>Tyre size</b>		<b>ø cat.</b>	<b>External width</b>	
650/75 R 32 167 A8	m	1.85	3.22	3.22
650/75 R 32 172 A8, Michelin	m	1.85	3.22	3.22
800/65 R 32 167 A8	m	1.85	3.58	3.58
800/65 R 32 172 A8	m	1.85	3.47	3.47
800/65 R 32 178 A8, Michelin	m	1.85	3.56	3.56

EVION		450	430	410
<b>Tyres on steering axle</b>				
<b>Tyre size</b>		<b>ø cat.</b>	<b>External width</b>	
16.5/85 24 14PR IMP	m	1.35	3.22	3.22
500/70 R 24 164 A8 IMP	m	1.35	3.27	3.27
500/70 R 24 164 A8	m	1.35	3.27	3.27
500/85 R 24 x 205 IMP	m	1.50	3.27	3.27

Front attachments	
VARIO cutterbars	VARIO 680, VARIO 620, VARIO 560, VARIO 500
CERIO cutterbars	CERIO 680, CERIO 620, CERIO 560
Standard cutterbars	C 490, C 430, C 370
Rapeseed equipment	For all VARIO cutterbars, not available for CERIO cutterbars
Folding cutterbars	C 540, C 450
Maize pickers	rows 6, 5
SUNSPPEED	rows 12, 8
MAFLEX	MAXFLEX 680, MAXFLEX 620, MAXFLEX 560
SWATH UP	SWATH UP 450

CLAAS continually develops its products to meet customer requirements. This means that all products are subject to change without notice. All descriptions and specifications in this brochure should be considered approximate and may include optional equipment that is not part of the standard specifications. This brochure is designed for worldwide use. Please refer to your nearest CLAAS dealer and their price list for local specification details. Some protective panels may have been removed to present the function more clearly in photographs. To avoid any risks, you should never remove these protective panels yourself. In this context, please refer to the relevant instructions in the operator's manual. All technical specifications relating to engines are based on the European emission regulation standards: Stage. Any reference to the Tier standards in this document is intended solely for information purposes and ease of understanding. It does not imply approval for regions in which emissions are regulated by Tier.



## EVION configuration.

### Models

<b>EVION 450</b> 258 hp, 8,000 l grain tank capacity	<b>MAXI</b> MULTICROP
	<b>CLASSIC</b> Universal Grain
<b>EVION 430</b> 231 hp, 6,500 l grain tank capacity	<b>MAXI</b> MULTICROP
	<b>CLASSIC</b> Universal Grain
<b>EVION 410<sup>1</sup></b> 205 hp, 5,600 l grain tank capacity	<b>CLASSIC</b> Universal Grain

<sup>1</sup> Only as Stage V

### Equipment packages

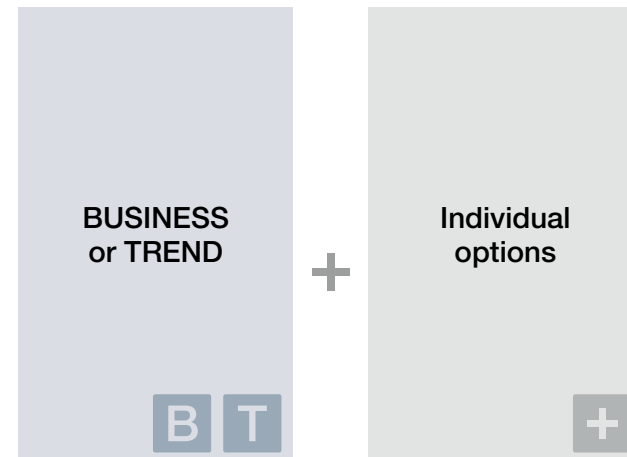

Models	MAXI	CLASSIC
Front attachments (max. size)	Cutterbars up to 6.80 m Maize picker, 6-row	Cutterbars up to 6.80 m
Front axle	With diff. lock	Without diff. lock
Rear axle	Variable	Rigid
Engine	With air compressor	Without air compressor
Threshing drum speed	2 ranges, 220-630 / 480-1150	1 range, 480-1150
Threshing concave	Threshing concave segment can be swapped out	One piece

### Equipment packages

	BUSINESS <b>B</b>	TREND <b>T</b>
Front attachment guidance	AUTO CONTOUR	CONTOUR
Crop cleaning	3D	-
Chopper	SPECIAL CUT	STANDARD CUT
Operation	CEMIS 700 incl. rear camera	CEMIS 700 incl. rear camera
Work lights	LED Plus	LED
Cab comfort and convenience	Air-suspended seat, instructor's seat with refrigerator box, foot rests, electrically adjustable rear-view mirrors	Air-suspended seat, instructor's seat with storage compartment, manually adjustable mirrors

### Individual options

Digital packages	Operator assistance systems
Individual cab comfort and convenience features	Multicrop capability
Lighting	Convenient maintenance
Ground speeds	Crop types and conditions



CLAAS KGaA mbH  
 Mühlenwinkel 1  
 33428 Harsewinkel  
 Deutschland  
 Tel. +49 5247 12-0  
 claas.com