



Forage harvesters

JAGUAR

990 980 970 960 950 940

CLAAS

Reliability with no compromises. The CLAAS JAGUAR forage harvesters.

The driving force of your harvesting team.

Quality that sets standards. Performance that has no equal. Comfort and user-friendliness that meet your every need. An uncompromisingly reliable machine: the **CLAAS JAGUAR series**.

Don't accept any compromises when it comes to harvesting: this brochure tells you about the key advantages of the CLAAS JAGUAR forage harvester. Your CLAAS dealer will be pleased to advise you in detail about all the new features and the attractive financing arrangements.



Scan me.

claas.com/feldhaecksler



At home in every field. The CLAAS JAGUAR 900 series.



The standard	2
50 Years of JAGUAR	6
Crop flow	10
Front attachments	10
Feeder unit	12
Front attachment drive	14
Feeder unit and precompression	16
V-MAX chopping cylinder	18
Chopper unit	20
MULTI CROP CRACKER	22
SHREDLAGE®	24
Discharge	26
Silage quality	28
CLAAS POWER SYSTEMS	32
Drive concept	34
Engines	36
Chassis	38
Cab and comfort	42
Operation	44
Comfort cab	46
Operator assistance systems	50
CEMOS AUTO PERFORMANCE	52
Steering systems	54
AUTO FILL	56
Yield measurement	58
Data management	60
CLAAS NIR sensor	62
Maintenance and service	64
Reliability	66
Maintenance concept	68
Hydraulics and electrics	70
PREMIUM LINE	72
Technology in detail	74
CLAAS Service & Parts	76
Advantages	78
Technical data	79



Efficient powerhouse.

Its 490 to 925 hp deliver outstanding performance along with high efficiency: harvesting with CEMOS AUTO PERFORMANCE engine management active can result in fuel savings of up to 12% and an increase in area output of up to 7% compared to harvesting without CEMOS. The combination of the direct drive from the engine to the chopper unit and the straight-line crop flow is the key to the JAGUAR's success.



Reliability.

The JAGUAR is built to the highest standards for you. Service and parts specialists ensure that you can get the best out of it in the field. If a problem should ever arise, CLAAS Service is available to assist you, around the world and around the clock. The result: reliable and long-lasting machines.



Operator assistance.

A quiet cab with intuitive, user-friendly controls. At its heart is the CEBIS control system which can be mastered intuitively in next to no time. Operator assistants are on hand to reduce your workload: AUTO FILL, AUTO PILOT, CEMOS AUTO PERFORMANCE and dynamic steering are just a few of the functions which help you to keep harvesting successfully throughout long working days.



Quality without compromise, as typified by SHREDLAGE®.

Intelligently controlled assistance systems allow you to achieve high silage quality every time. And, because this is the CLAAS JAGUAR, you can do so while maintaining an optimal ratio of fuel consumption to yield (l/t). Its intelligent crop processing systems enable an increase of up to one litre in the daily milk yield compared with the result obtained with feeding conventional silage.



Trust the world champion.

- Over 45,000 forage harvesters produced in 50 years
- Some 90,000 owners on the base of one resale per machine
- An impressive 180,000 operators on the basis of at least two operators per machine
- A mighty 20,000,000 hp (estimated) of JAGUAR power in all markets to date

50 Years of JAGUAR. Unstoppable.

A pioneer yesterday, the market leader today: CLAAS has been making history with its forage harvesters since the 1970s. From the legendary JAGUAR 60 SF to the JAGUAR 900-series, the machines' performance, efficiency and driving comfort have increased continuously. Today's foragers are more productive than ever.



The "50 Years of JAGUAR" anniversary package is available as an option.



Silage additive utensils

1973



JAGUAR 60 SF

1980



JAGUAR 690

1992



JAGUAR 880

2007



JAGUAR 980

2018



JAGUAR 960 TERRA TRAC

2023



Unstoppable.

The JAGUAR. The secret of its success.

Making improvements where they have the greatest impact.

The JAGUAR allows you to keep operating costs down. Its strengths lie in its economical fuel consumption, its many operator assistance systems, the outstanding forage quality it produces and its high reliability. It all adds up to an investment that pays.



The JAGUAR



- Since 1973: systematic development based on listening to our customers and practical experience gained around the world
- Premium manufacturing quality featuring MAN and Mercedes-Benz diesel engines
- Excellent harvest quality with V-MAX, chopping cylinder and MULTI CROP CRACKER system / SHREDLAGE® technology
- High value retention through professional used machine network and marketing through FIRST CLAAS USED

The operator



- Spacious cab and good driving comfort make for a workplace with the feelgood factor
- Straightforward operation
- Quietest cab in the market
- Operator assistance systems such as AUTO FILL
 - 50% fewer clicks on the joystick
- CAM PILOT, AUTO PILOT
 - up to 65% fewer steering wheel movements
- CEMOS AUTO CROP FLOW – for more reliable operation in challenging harvesting conditions

The fuel efficiency



- Direct drive
- Straight-line crop flow
- Optimisation of logistics and process times
- CEMOS AUTO PERFORMANCE
 - up to 12% less fuel
- DYNAMIC POWER
 - up to 10.6% less fuel
- DYNAMIC COOLING
 - savings of up to 10 kW
- Accelerator gap setting
 - savings of up to 15 kW
- Tyre pressure control system
 - 5% less fuel

The easy maintenance



- Excellent accessibility by swinging feeder housing open to the side and easy fitting/removal of the corncracker
- Central lubrication system as standard: lowest number of manual lubrication points in the market
- V-MAX knives with only two bolts per knife: no need to adjust the shear bar or readjust the V-MAX knives

First CLAAS Service



- Professional customer service, professional distributors
- Fast parts service with rapid worldwide availability
- Remote Service: proactive maintenance planning and reduced downtime

The reliability



- Long service life
- PREMIUM LINE packages with guaranteed wear resistance of designated parts for 3,000 hours of engine operation or 5 years of use*

* for selected components and CLAAS sales regions

Optimal crop flow begins with the front attachment.

At work all over the world.

The need for ever higher yields means that the demands placed on forage harvesters are also increasing. Clean crop intake, robust technology and versatility are the all-important factors. With its wide range of front attachments, the JAGUAR is today at work around the world, harvesting a very wide range of crops. The front attachments can be fitted and removed easily, are driven via quick-release couplers and impress with their outstanding ground adaptation.



Unique.

ORBIS 900 folds down to a transport width of 3 m, providing excellent visibility

Find the right front attachment for your JAGUAR.

Scan me.



PICK UP 380 / 300.

- Two independently controlled drives for intake auger and pick-up, adjusted automatically in accordance with length of cut and ground speed
- Robust roller crop press with large intake auger for high throughput
- ACTIVE CONTOUR for automatic ground adaptation

DIRECT DISC 600 / 500 and 600 P / 500 P.

- MAX CUT mower bed for very clean crop cutting
- Paddle roller for optimal crop flow in short crops
- Very large intake auger for high throughput
- Roller crop press for extremely even transfer of crop flow



ORBIS 900 / 750 / 600 / 600 SD / 450.

- Maize front attachments with working widths from 4.5 m to 9.0 m
- No need to get down from cab with automatic transport protection for ORBIS 900-600
- ORBIS 900-450 with 3 m transport width
- AUTO CONTOUR available for automatic ground adaptation and automatic steering mechanism



Adapter for CORIO and CONSPEED.

- Fast and convenient connection of combine harvester front attachments, such as maize pickers for harvesting maize cob silage
- Integrated feed roller for even crop flow
- Drive connection to JAGUAR made via quick-release coupler

High performance and low consumption.

1. Two front attachment drives.

- Standard drive is direct via the quick release coupler. With constant or variable speed for optimal chopping quality through appropriately adjusted, consistent crop feed from the front attachment to the feed rollers
- Option: additional, second variable drive with independent adjustment of the speed of the pick-up reel. For the most efficient forage intake and a crop feed matched to the current performance of the machine

2. Feeder unit.

- Hydraulic precompression for excellent chopped material quality
- Chopping cylinder is easily accessible through QUICK ACCESS

3. V-MAX chopping cylinder.

- For high throughput
- Extremely maintenance-friendly design uses only two bolts to secure knives
- No need to readjust knives

4. MULTI CROP CRACKER.

- For high-quality maize silage processing
- From extremely short lengths of cut up to SHREDLAGE® with lengths up to 30 mm

5. Flexible acceleration.

- Accelerator clearance can be set from the cab

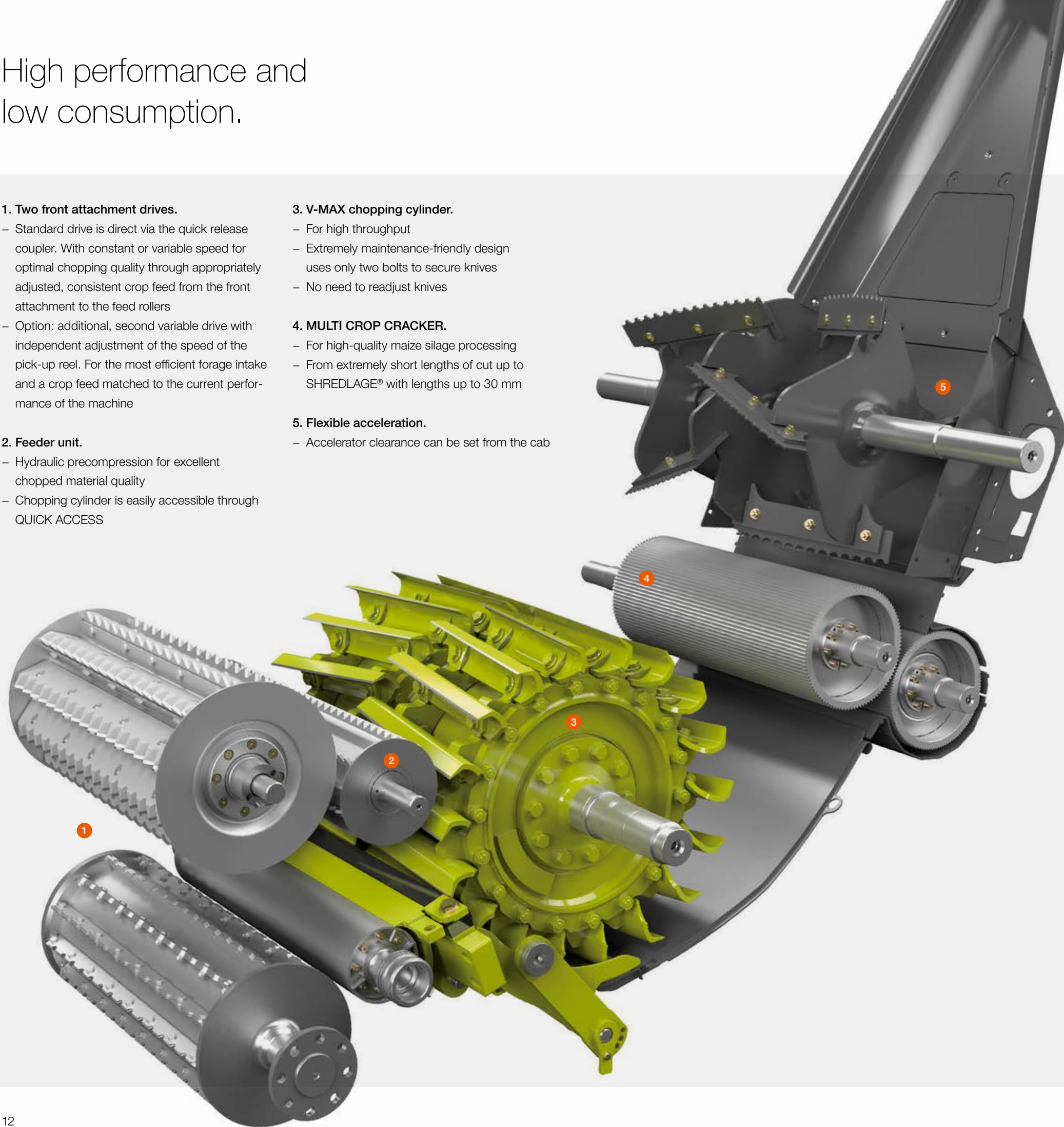

Straight, fast crop flow saves energy.

The optimised crop flow of the JAGUAR increases your daily output to a significant degree. The crop flows in a straight line through the entire machine without any awkward angles. It is accelerated further at each step and is centred progressively by the V-shaped arrangement of the knives and accelerator paddles. As well as making for highly reliable operation, this results in maximum throughput while keeping the power requirement to a minimum – thereby leading to impressive fuel savings in terms of litres per tonne.



SHREDLAGE®

Drive power is tailored to the requirements of each front attachment.

Front attachment drive.

All the front attachment drives are integrated in the main drive train. In this way, the front attachment drive, feeder drive, chopping cylinder speed, accelerator and corncracker are able to react equally to engine speed variations. The advantage for you is that a constant length of cut is always maintained.

1. Mechanical drive, suitable for all front attachments.

- For conventional use where there is no requirement for automated speed adjustment in constant harvesting conditions
- Chopping cylinder shaft driven entirely mechanically at constant speed
- Engaged via a belt clutch to the quick-release coupler

2. Split-power front attachment drive.

- Front attachment driven mechanically via the chopping cylinder shaft with additional hydrostatic support and maximum power transmission at constant rpm
- Suitable for direct mechanical drive of DIRECT DISC and maize picker
- With the right-hand drive belt removed, the front attachment is driven hydraulically with variable speed adjustment for PICK UP and ORBIS
- Variable speed adjustment can be automated for an even crop flow delivering top-quality chopped material

3. Variable front attachment drive for ORBIS maize front attachments and PICK UP.

- All-hydrostatic drive
- Manual or automatic speed adjustment in accordance with the preset length of cut with low power requirement

4. Two independent, variable front attachment drives.

- Variable drive for intake auger via quick release coupler with speed adjusted automatically in accordance with the length of cut and driving speed
- Hydraulic drive for pick-up with automatic speed adjustment in accordance with the driving speed

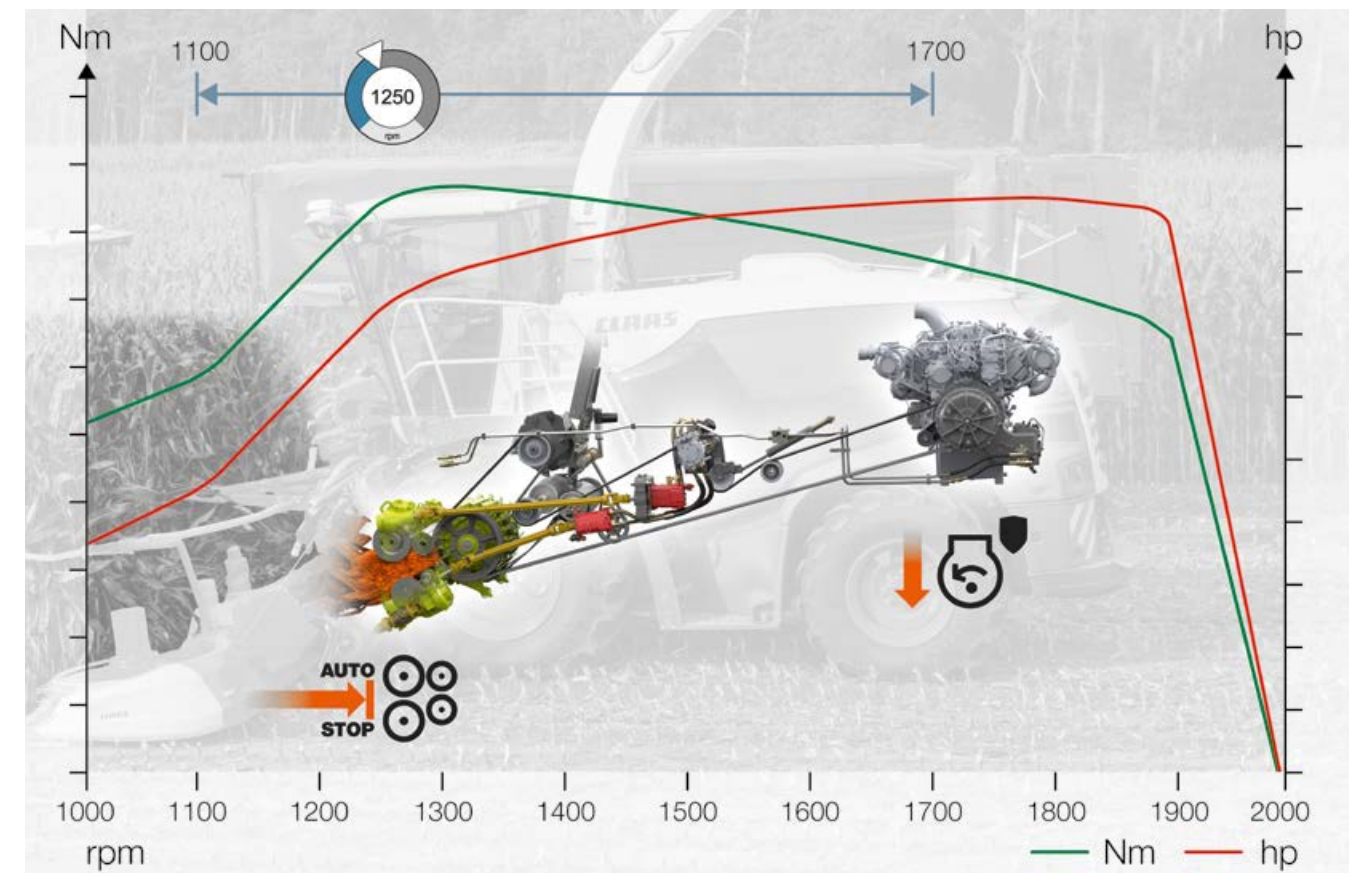

NEW: CEMOS AUTO CROP FLOW

The crop feed can be stopped automatically when detection of a preset engine speed causes the feeder unit and front attachment to be switched off. In this way, it is possible to avoid downtime in critical harvesting conditions.

Adjusted automatically. Pick-up performance and intake auger speed.

- Even crop flow with extremely high or changing yield and different harvesting speeds
- Efficient crop intake under all operating conditions

CEMOS AUTO CROP FLOW

- Automatic stop of the crop feed
- Minimum engine speed can be set as required between 1,100 and 1,700 rpm

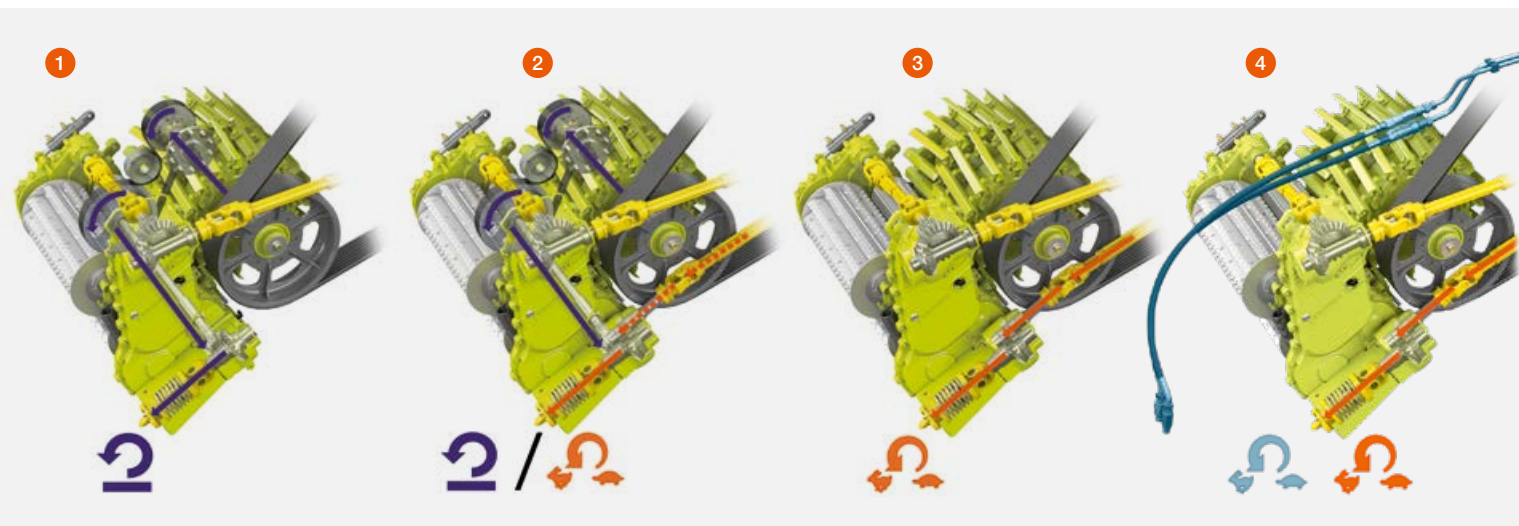

Good forage needs plenty of pressure.

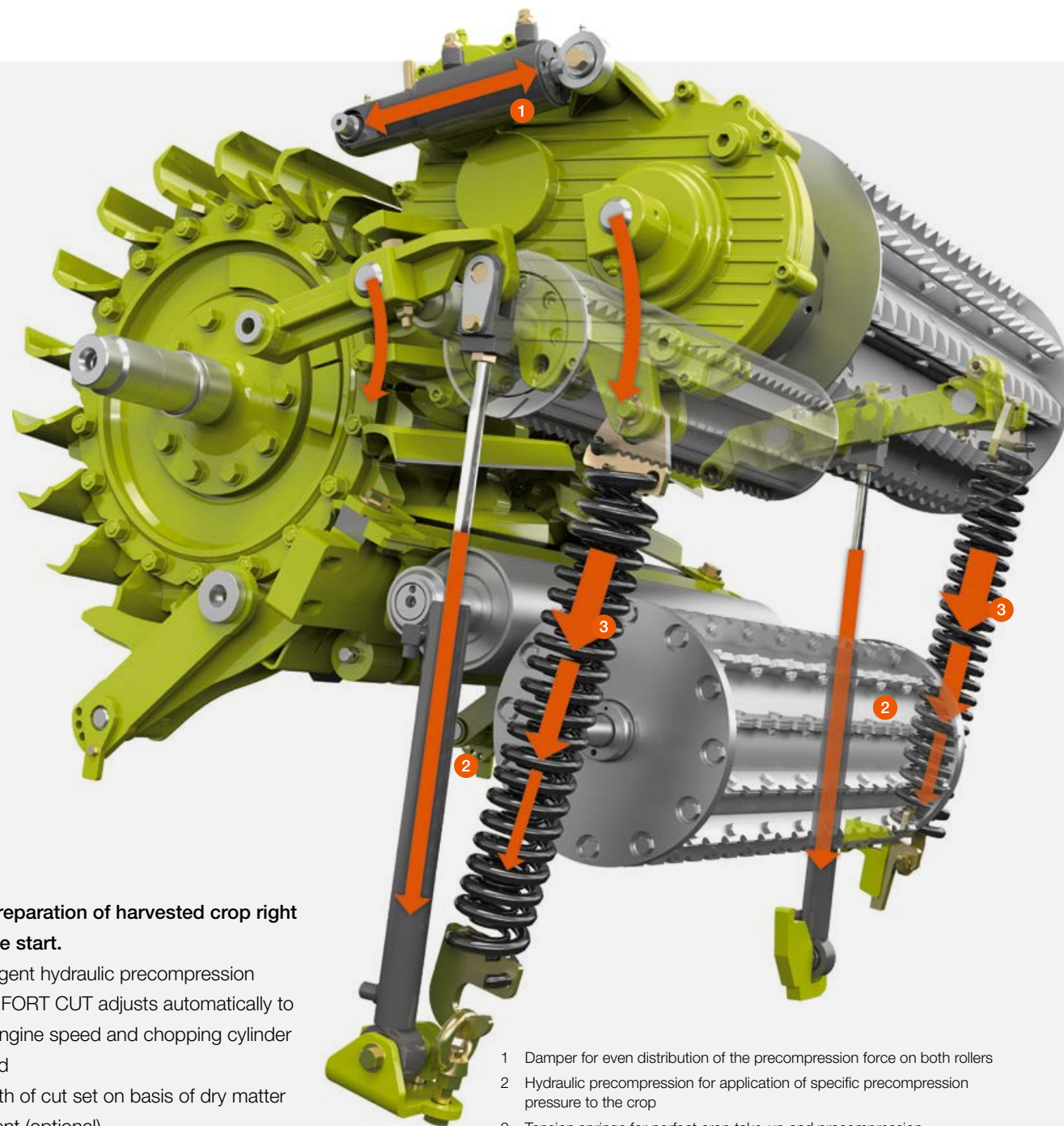

Ideal preparation of harvested crop right from the start.

- Intelligent hydraulic precompression
- COMFORT CUT adjusts automatically to the engine speed and chopping cylinder speed
- Length of cut set on basis of dry matter content (optional)

- 1 Damper for even distribution of the precompression force on both rollers
- 2 Hydraulic precompression for application of specific precompression pressure to the crop
- 3 Tension springs for perfect crop take-up and precompression

Intelligent hydraulic precompression.

Acting via two hydraulic rams with pressure accumulators, the rear upper precompression roller applies a specific degree of pressure to the crop. Special control characteristics are used to adjust the precompression pressure automatically to different crops and changes in the thickness of the crop flow.

Even when there is only a thin crop flow, the precompression roller always exerts the same pressure on the crop layer. This produces consistently good chop quality.



Consistently high-quality chopped material.

COMFORT CUT, the infinitely variable length of cut adjustment which can be automated, maintains a constant length of cut at all times. The COMFORT CUT drive adjusts automatically to any changes in the engine speed or the speed of the chopping cylinder. CEBIS provides you with a convenient interface for setting the required length of cut. Using the optional NIR sensor, you can adjust the LOC in accordance with the measured dry matter content. In this way, the JAGUAR automatically produces perfect silage for compression in the clamp.

- Ideal preparation of the harvested crop through hydraulic precompression control for consistently high-quality chopped material
- Very gentle crop flow
- Constant length of cut, even if there are variations in the engine speed
- NIR sensor enables automatic length of cut control in accordance with the dry matter
- Very convenient maintenance through hydraulic lifting of the precompression rollers



Forage cutting with millimetre accuracy.

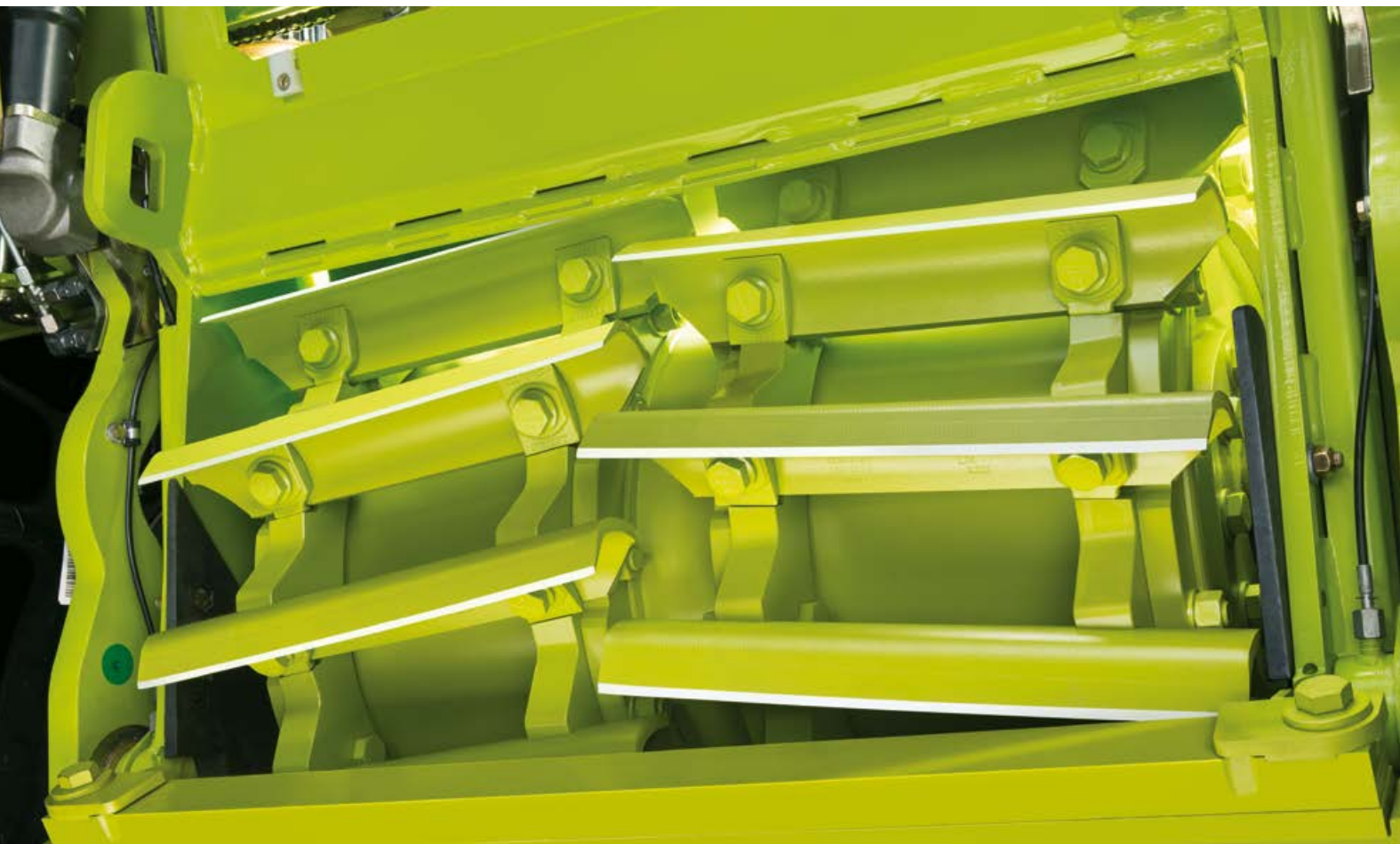

V-MAX 28

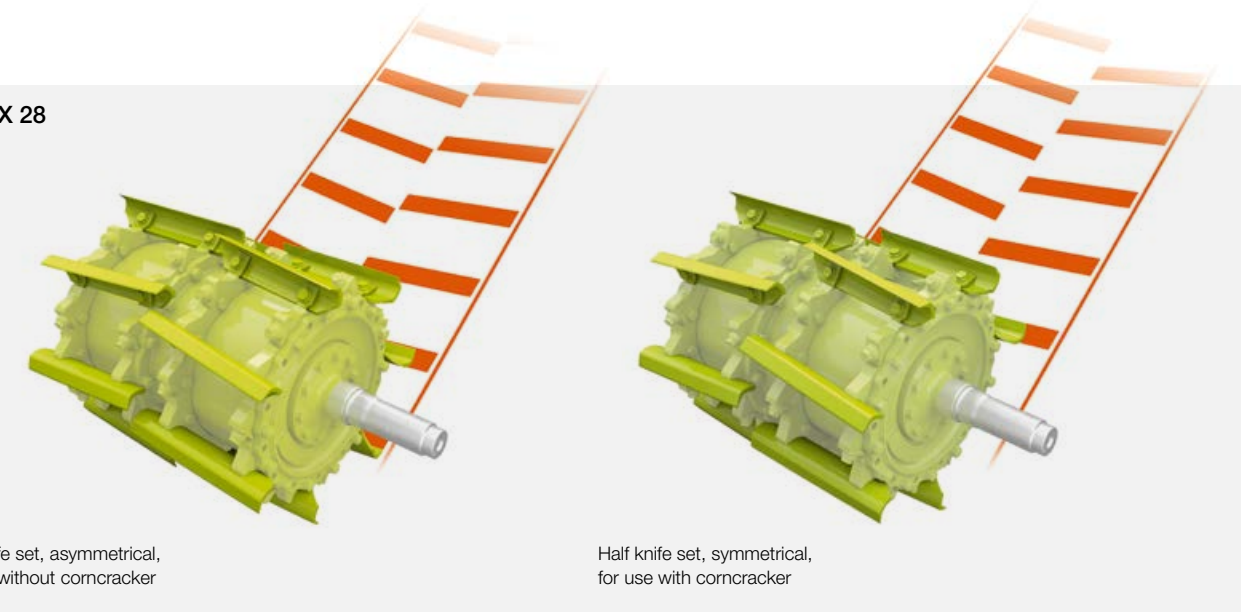

Half knife set, asymmetrical, for use without corncracker

Half knife set, symmetrical, for use with corncracker

Highly flexible.

The V-MAX chopping cylinders extend your length-of-cut range. Harvesting up to a length of cut of 30 mm is also possible with a corncracker. With the V-MAX 36 / 28 / 24, you simply adjust the position of the knife carriers and halve the number of knives. Through the symmetrical crop delivery you benefit from high operating reliability and achieve very uniform crop processing by the corncracker.

- Extremely smooth, power-saving action: the curved shape of the knives makes for an optimum crop flow
- High strength: chopping forces are taken up directly by the star-shaped cylinder
- Easy to fit: just two bolts per knife, no need for adjustment/readjustment
- Symmetrical crop discharge: with half the full number of knives through repositioning of knife carriers; also enables use with corncracker up to lengths of cut of 30 mm

V-MAX 42 chopping cylinder.

Available in five variants, V-MAX chopping cylinders are ideally matched to your requirements. With 42 knives and a cutting frequency increased to 25,200 cuts per minute, the V-MAX 42 chopping cylinder is able to deliver particularly high throughput.

Using the full engine output, it is able to deliver short lengths of cut from 3.5 to 12.5 mm with precision. Greater lengths can be produced by using one third of the number of knives. The V-MAX 42 is available as an option for the JAGUAR 990, 980 and 970.

High performance. High cutting frequency.

- V-MAX 42 chopping cylinder for very high throughput with short lengths of cut
- Extended length-of-cut range through use with one third of the number of knives and the corncracker



Lengths of cut provided by the V-MAX chopping cylinders.

V-MAX	rpm	1/1	1/2	1/3	mm											
					1	5	10	15	20	25	30	35	40	45	50	
V-20	12000	20 (2x10)	-	-												
	6000	-	10 (2x5)	-												
V-24	14400	24 (2x12)	-	-												
	7200	-	12 (2x6)	-												
V-28	16800	28 (2x14)	-	-												
	8400	-	14 (2x7)	-												
V-36	21600	36 (2x18)	-	-												
	10800	-	18 (2x9)	-												
V-42	25200	42 (2x21)	-	-												
	8400	-	-	14 (2x7)												

Sharpness makes for more precise chopping.

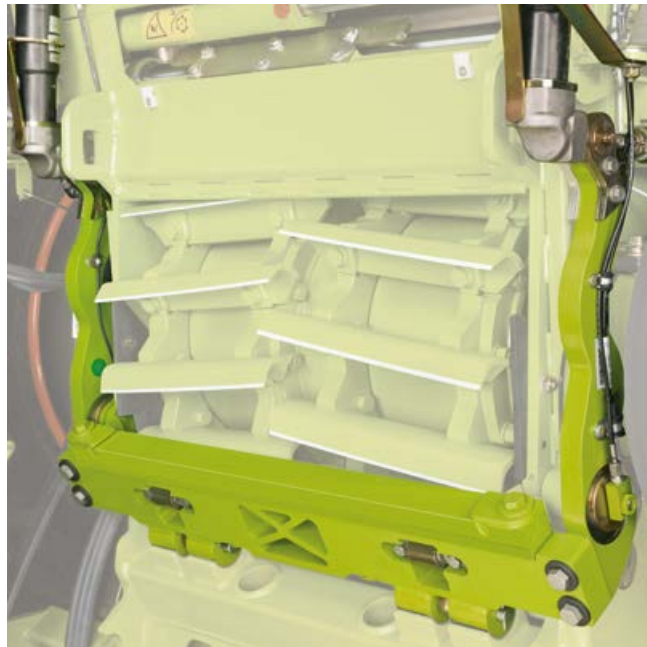

Hydraulically locked shear bar.

The shear bar is attached securely to the mounting block by four bolts. In less than 60 seconds, the shear bar with the mounting block is pivoted precisely towards the chopping cylinder which is rotating forwards. The hydraulic system releases the side shear bar clamps and secures them again once the adjustment is complete. In this way, the setting required for precise cutting is maintained reliably.

Knife sharpening on basis of throughput.

You can use CEBIS to program whether knife sharpening is to be performed after a given period of time has elapsed or on the basis of the throughput quantity. CEBIS will then provide a reminder when sharpening is due. Erosion of the knife material usually starts in front of the sintered inner wear-resistant area on the knife. The hard sintered area lasts longer, delivers superior performance and has a self-sharpening effect.

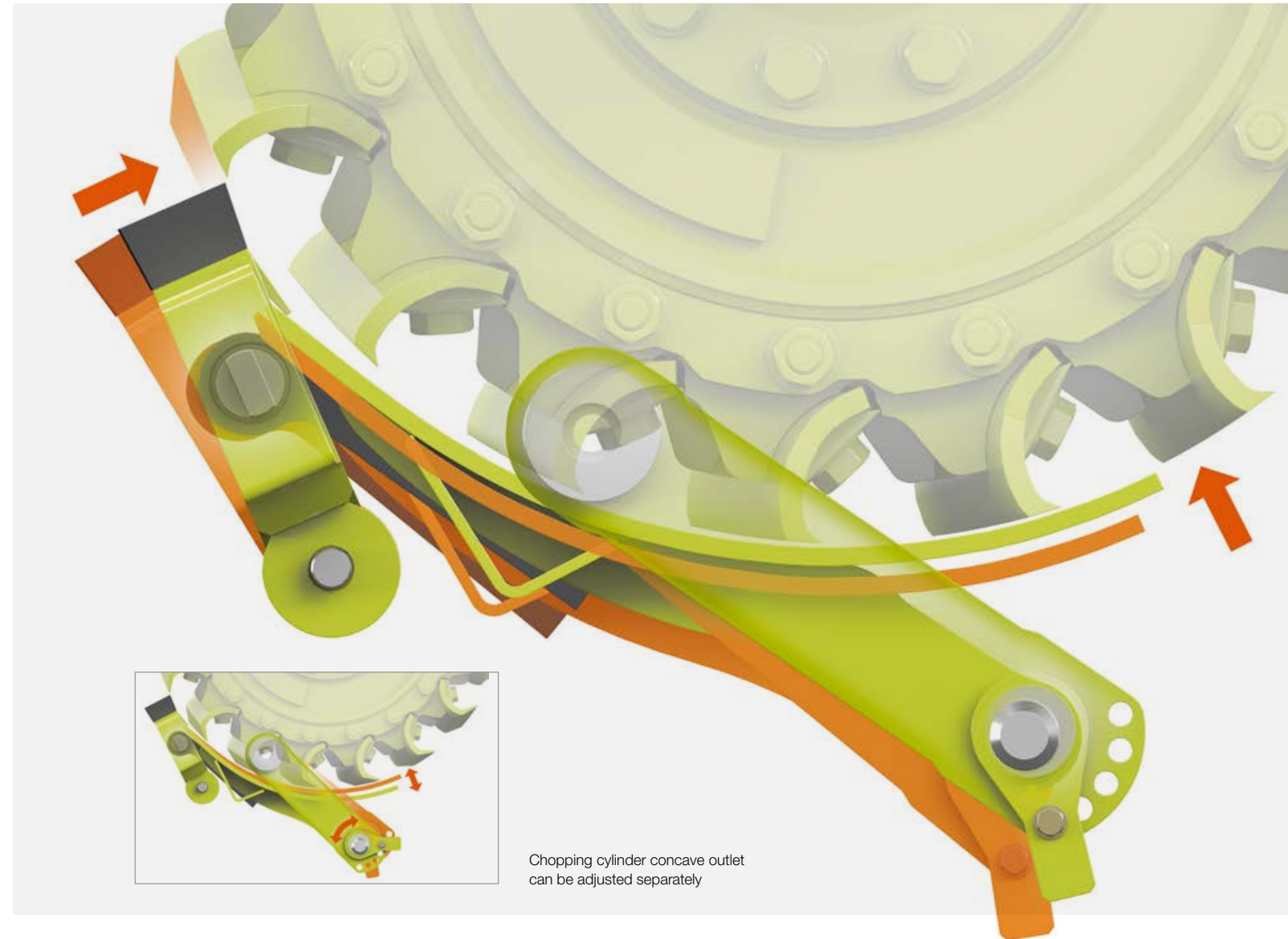

Chopping cylinder concave outlet can be adjusted separately

Sharp knives for precise cutting.

- Knife sharpening based on time or throughput
- Precise, even sharpening through exact grindstone guidance
- Reliable protection against dirt and noise

- Easy adjustment aid for grindstone replacement
- Hydraulic shear-bar clamping reliably maintains correct distance to chopping cylinder
- Chopping cylinder concave adjusts automatically for consistent crop delivery under all harvesting conditions

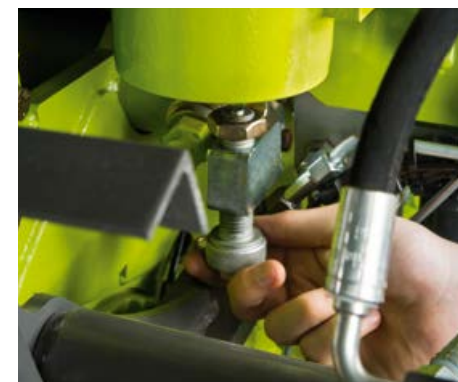

Grindstone adjustment aid

Automatic adjustment of chopping cylinder concave.

The front of the chopping cylinder concave is supported on the mounting block while the rear is secured by pivot arms. When the shear bar is adjusted, the chopping cylinder concave is automatically positioned relative to the chopping cylinder. This arrangement ensures consistent crop delivery during the entire service life of the knives.

Easy adjustment of chopping cylinder concave outlet.

The chopping cylinder concave outlet can be adjusted separately if this is required by the harvesting conditions.

Specialists deliver top-quality results.

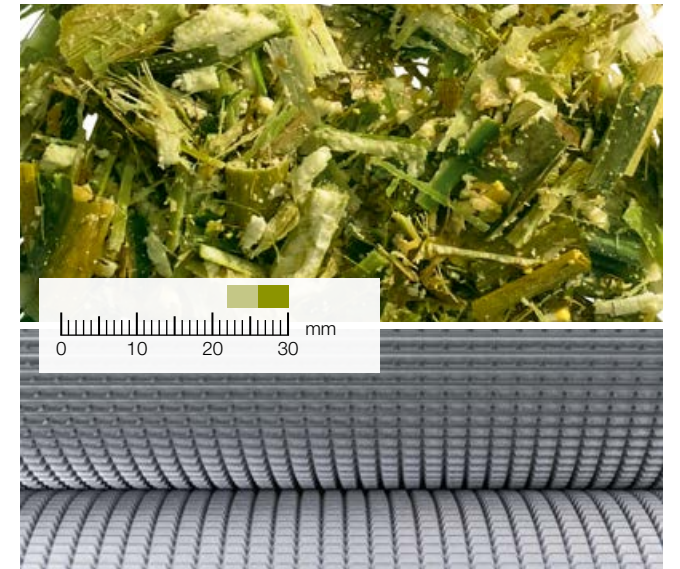

MCC CLASSIC.

The conventional MCC CLASSIC has the proven sawtooth profile and operates with a standard speed difference of 30%. This system can be used successfully when harvesting short maize for biogas plants or producing silage for dairy cattle and finishing beef bulls. The kernel processing score can be increased by adjusting the speed difference.

MCC MAX – the power of four.

- 1 Maximum service life through high level of wear protection with Busa®CLAD coating
- 2 Maximum kernel processing
- 3 Maximum possible throughput supported (attained with JAGUAR 990 with engine output up to 925 hp)
- 4 Maximum flexibility to meet different requirements

3,160 hectares of maize in three harvests.

Contractor Meyer from Meppen-Apeldorn will use the MCC MAX for a fourth maize harvest.

MCC MAX.

The MCC MAX rollers have 30 ring segments with a sawtooth profile. The arrangement and special geometry of the segments ensure that the crop is processed not only by crushing and friction, but also by cutting and shearing forces. This breaks down the maize kernels more intensively and shreds the stalk fragments.

Compared with conventional corncrackers, the MCC MAX has a much wider field of application with regard to lengths of cut and dry matter. At the same time, it delivers processing results of extremely high quality. Its forage processing capability meets the most diverse customer requirements without the need for any change to the machine's equipment.

MCC SHREDLAGE®.

Originally developed in the US, this technology is used on many farms around the world in the extremely long length-of-cut range from 26 to 30 mm.

The rollers have a sawtooth profile with an additional counter-directional spiral groove and operate with a speed difference of 50%. In this way, the MCC SHREDLAGE® is able to grind the maize kernels thoroughly, chop up the cob fragments completely and shred the leaves effectively. In addition to these processing actions, the spiral groove subjects the stalk material to a lateral effect which causes the bark to be rubbed off the stalk. At the same time, the soft inner core is split lengthways. SHREDLAGE® silage can be compressed very well as the material meshes during storage and rebound effects are minimal.

MULTI CROP CRACKER modes of action	CLASSIC	MAX	SHREDLAGE®
Adjustable cracker roller gap	☐	☐	☐
Number of teeth per roller and diameter for crop take-up and kernel size	125 / 125 for 250 mm Ø 100 / 100 for 196 mm Ø	120 / 130 for 245 / 265 mm Ø	110 / 145 for 250 mm Ø 95 / 120 for 196 mm Ø
Roller speed difference for frictional effect	30%	30%	50%
Engagement of ring segments for cutting effect	–	☐	–
Slanting of ring segment teeth for shear effect	–	☐	–
Counterdirectional spiral groove for peeling effect	–	–	☐

☐ Available – Not available

SHREDLAGE® for quality milk and meat.



SHREDLAGE® quality begins with the forage harvesting process.

The intensive processing of the crop increases the surface of the chopped material. This results in significantly improved bacterial fermentation during ensiling and, above all, during digestion in the rumen.

Trials conducted by the University of Wisconsin in Madison have shown that SHREDLAGE® drastically increases the physical effectiveness of maize silage while also improving the availability of the starch content. Furthermore, the rumen-friendly structure of the silage promotes herd health.

SHREDLAGE® also for finishing bulls.

The almost complete absence of any examination of the effects of feeding finishing bulls with SHREDLAGE® prompted Osnabrück University of Applied Sciences to conduct the first such feed trial with 72 Fleckvieh bulls. Feeding with SHREDLAGE® has a positive effect on the carcass yield. Higher conformation results in superior grading and a significantly lower fat score.

Improved livestock health is only one of many advantages which SHREDLAGE® has to offer you. As the availability of starch is optimised, you can reduce the quantity of feed concentrate used. It is also possible to limit or even eliminate the use of fibre supplements such as straw.



Test results of SHREDLAGE® feed trials conducted with finishing bulls by Osnabrück University of Applied Sciences.



The right gap setting cuts costs.

The size of the gap between the rollers determines how intensively the chopped material is processed. The principle to follow here is: only as intensive as necessary. The smaller the gap, the more intensively the crop is processed and the higher the energy requirement of your JAGUAR. This, in turn, means that you will incur higher harvesting costs.

MULTI CROP CRACKER for the best forage.

- For very high throughput with optimal processing of the chopped material
- Rugged design through large bearing units and sealed housing
- With maintenance-free belt under constant hydraulic tension for maximum power transmission
- Easily accessible for maintenance or changing rollers

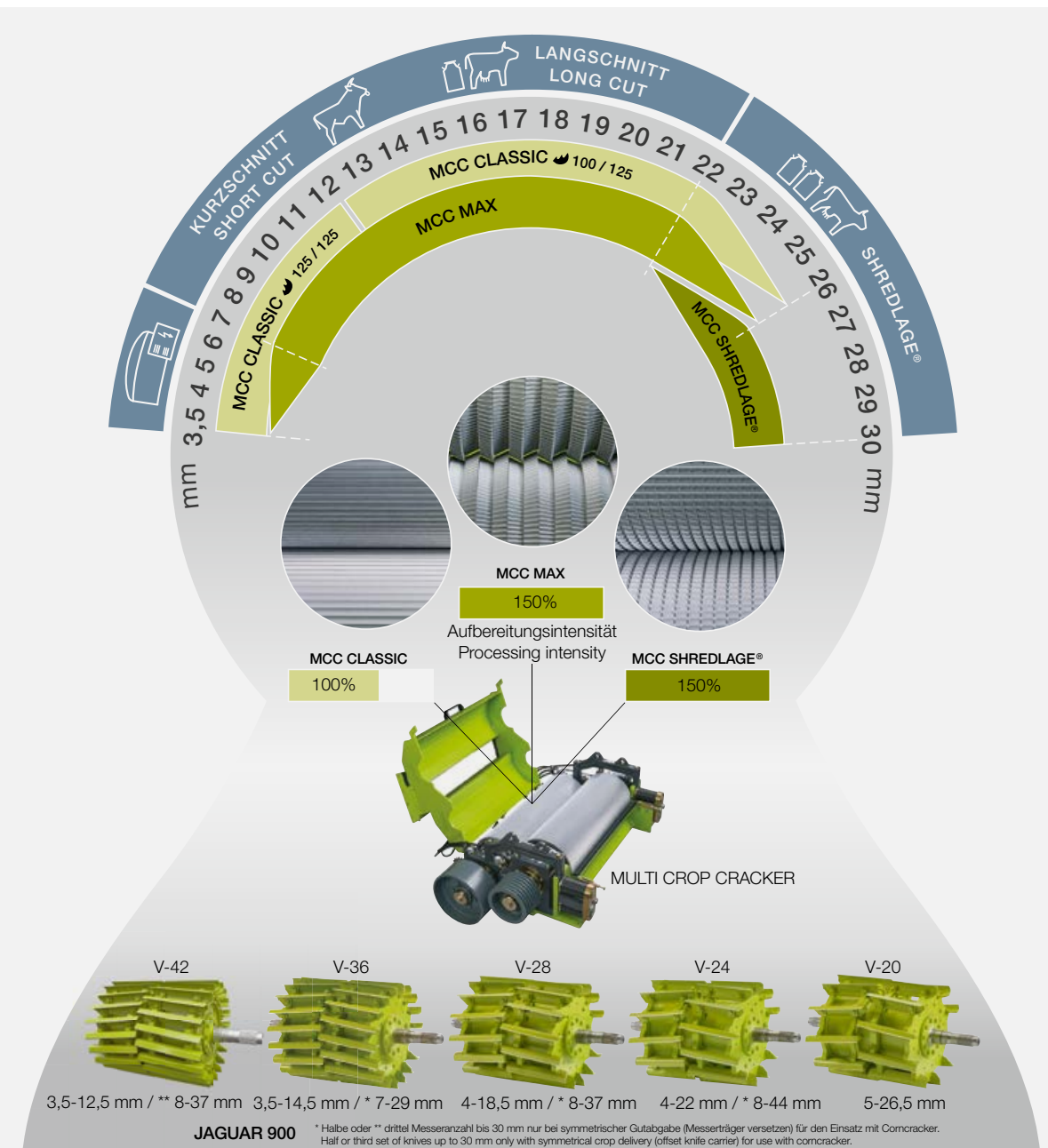

Collect your crop quickly and reliably.

Acceleration – the energy-saving way.

The accelerator is ideally positioned in the JAGUAR. The crop flow does not have to negotiate any awkward angles and is centred by the V-shaped accelerator paddles. This reduces the energy requirement and wear to the side walls.

Discharge capacity can be increased easily.

For heavy crops, you can increase the clearance between the accelerator and the rear wall hydraulically by up to 10 mm. This results in a further reduction in the amount of energy required. If, for example, you are working in very dry grass or starting chopping in a new field and require a high discharge capacity, the clearance can be reduced drastically. You can even make this adjustment conveniently in CEBIS while travelling and have it applied automatically at the start of the chopping process.

For maintenance tasks, such as replacing wear parts, the crop accelerator can be removed quickly and easily. Two experienced engineers require only about an hour for this.

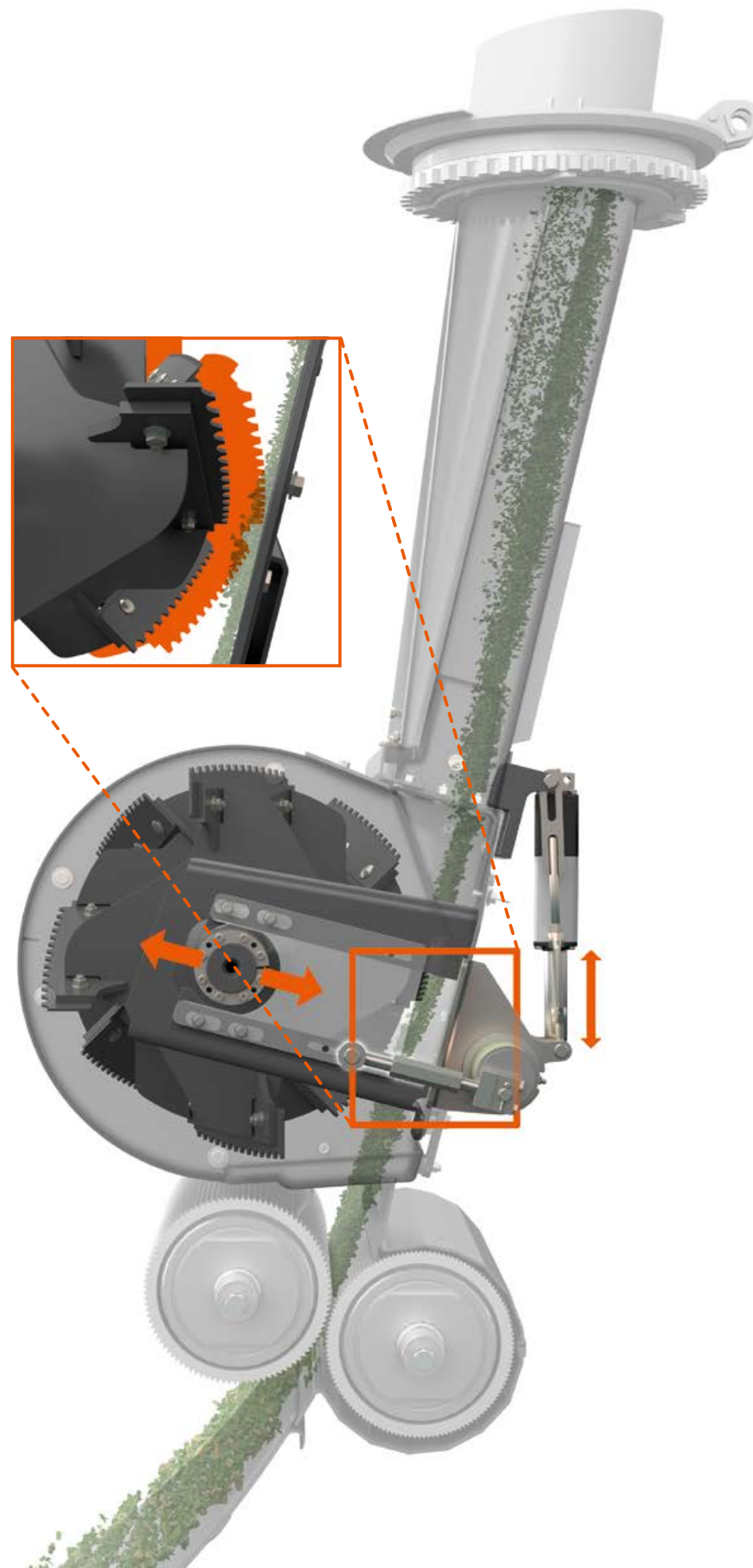

Easy removal and installation of the accelerator

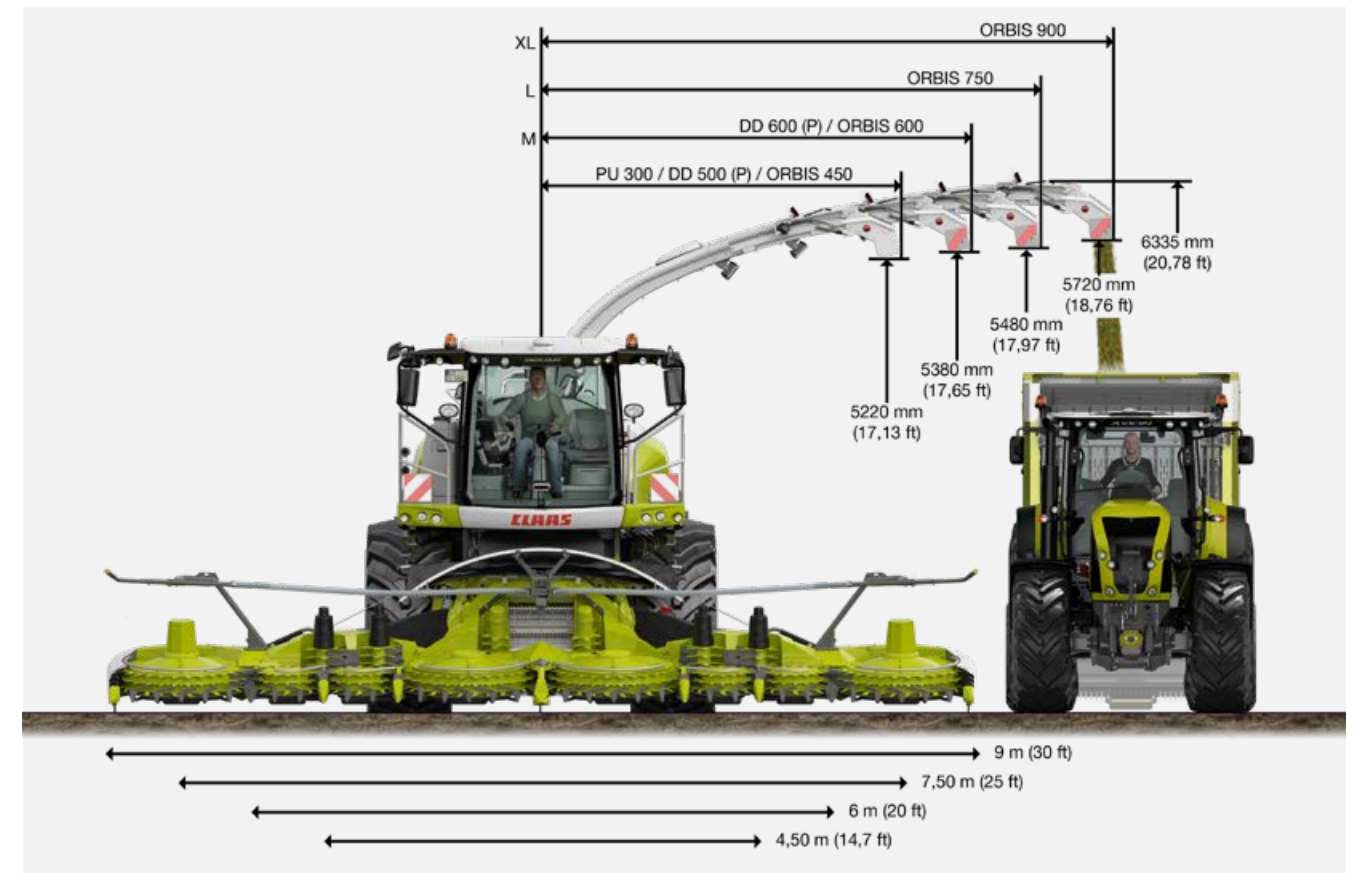

Reliable crop transfer up to a working width of 9 m.

High strength and a low dead weight are the key characteristics of the discharge chute. The highly concentrated crop stream can be directed more reliably, minimising wasteful losses. The modular design makes it possible for the system to be adjusted to different working widths.

Three extension modules in sizes M, L, and XL allow you to achieve a reliable crop transfer with working widths up to 9.0 m. The entire back of the discharge chute is bolted so that the back plates also function as wear plates.



Flexible discharge characteristics.

- You save on the energy required for acceleration.
- You can increase the discharge capacity straight from the cab when necessary.
- The discharge chute has a modular design.
- Working widths up to 9.0 m are possible.

All additives are dosed precisely.

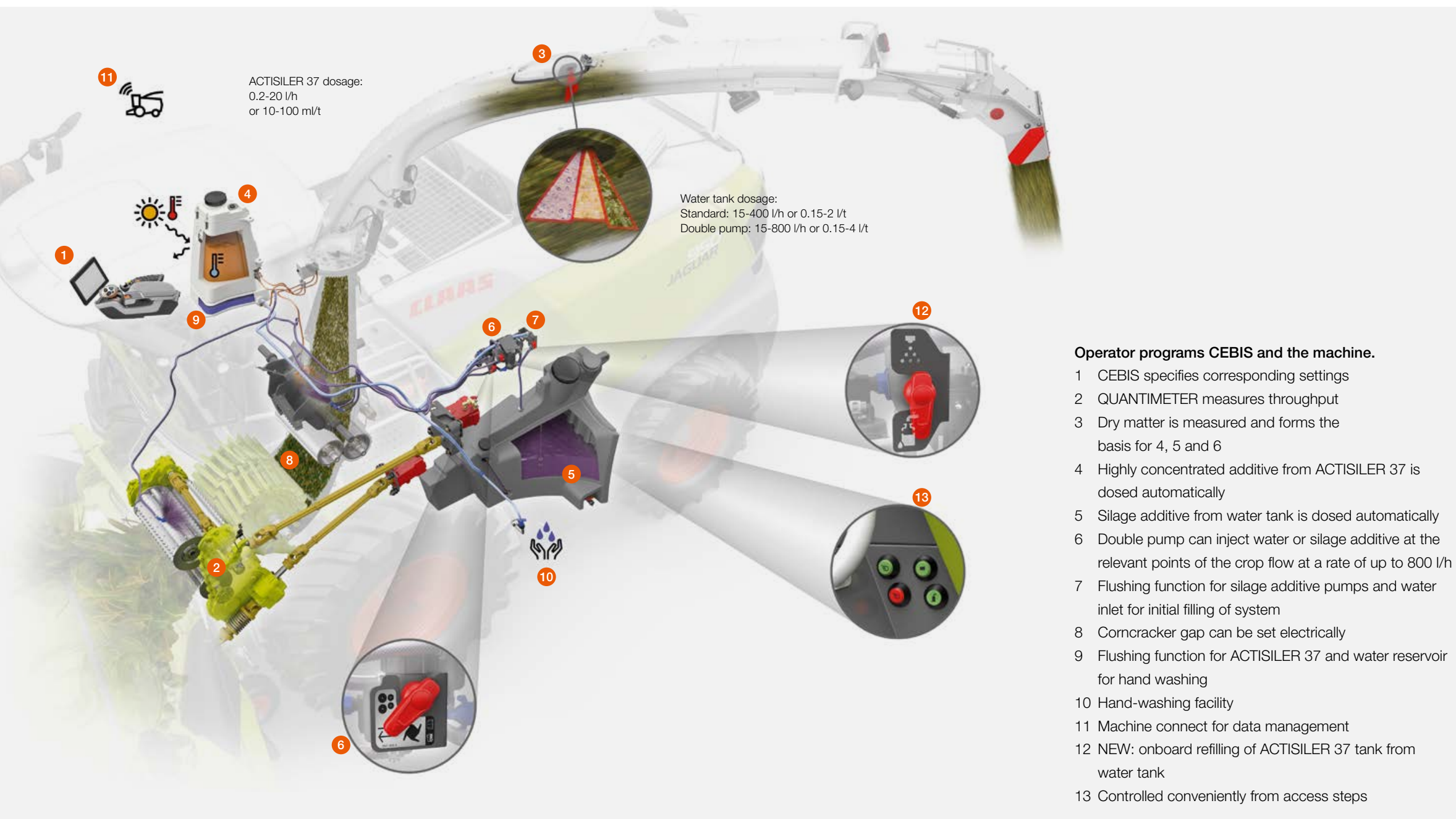

Concentrate from the thermotank.

The double-wall ACTISILER 37 tank protects your silage additive concentrate from high temperatures. For example, if the tank is filled with concentrate at 19°C, it will rise to a maximum of 23°C over a period of ten working hours when the outside temperature is 40°C.

NEW: The ACTISILER 37 system can be refilled with water directly from the large water tank.

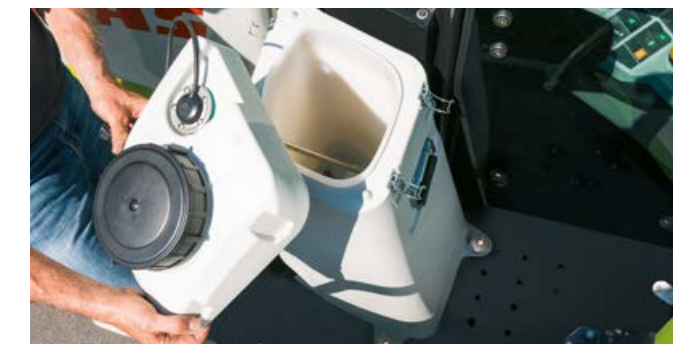

Forage at its finest.

High-quality silage increases the milk yield and stabilises animal health over the long term. The intelligent systems of the JAGUAR form the basis for excellent forage quality: with precisely dosed additives from the 375-litre tank or highly concentrated ones from the new ACTISILER 37. The dry matter content value determined by the near infrared sensor (NIR sensor) serves as a reference for setting the length of cut and the additives.

centrated ones from the new ACTISILER 37. The dry matter content value determined by the near infrared sensor (NIR sensor) serves as a reference for setting the length of cut and the additives.

Dosage via CEBIS.

CEBIS provides the operator with a clear overview of the automatic interplay between the measured dry matter content and the length of cut as well as the silage additive dosage.

- 1 Length-of-cut indication
- 2 Dosage applied on basis of current dry matter content
- 3 Programmed dosage from 375 l tank
- 4 Programmed ACTISILER 37 dosage

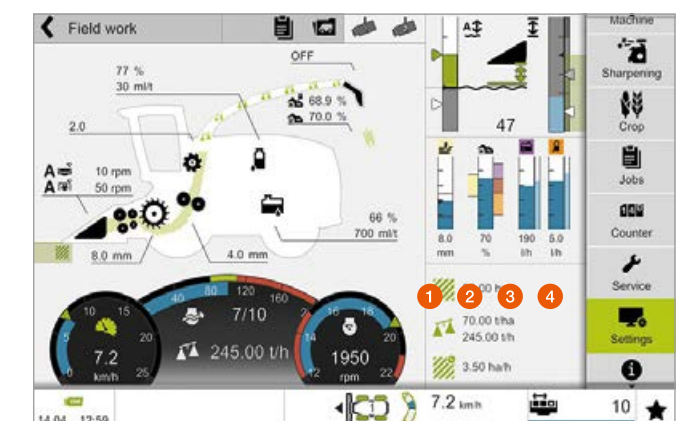



App: helps determine the correct silage additive dosage

Precise dosage with the CLAAS silage additive app.

The app uses the silage additive characteristics, the type of crop and the chosen tank capacity to help you find the correct settings to deliver the required daily dosage. Once you have entered the manufacturer's recommended silage additive instructions and the key data of the JAGUAR, the app calculates the precise dosage for the crop and the harvesting process. The silage additive app is available through CLAAS connect for Android and Apple.

Key data for precise dosage.

- What is the estimated yield (t/ha)?
- What is the size of the area to be harvested (ha)?
- What quantity of silage additive is recommended (g/t)?
- What is the quantity of silage additive in a pack (g)?

Matched to the specific situation.

Once the app has shown you how much silage additive you require, you can determine the dosage. To do this, you need more information:

- Which silage additive system is to be used (ACTISILER or silage water tank)?
- How full is the tank concerned?
- What is the working width (m)?
- What is the estimated working speed (km/h)?
- Is dosing to be performed in l/t or in l/h during chopping?

It only remains for you to enter the calculated dosage in CEBIS. Corrections can be entered at any time while chopping is underway.



Filling the silage additive tank



Entering the app's recommendation in CEBIS

CLAAS Connect.
Get your silage additive app now.

Scan me.



Water to prevent crop flow issues.

If you are harvesting crops with a high sugar content, the programmed injection of water at specific points in the crop flow path — such as the feeder unit, guide plate, accelerator and upper discharge chute — reduces the build-up of sticky material.

Whenever the crop flow ceases, at the headland, for example, or during forage trailer changeovers, water can be injected automatically. The water from the 375-litre tank moistens the sticky material in the crop flow path. When the crop starts flowing again, the harvested material cleans the crop flow path. It is then possible for silage additive to be injected using the ACTISILER 37 tank.

Silage additive injection up to 800 l/h.

For extremely high silage additive dosage rates, a second silage additive pump can be used to double the dosage rate from 400 l/h to 800 l/h. Control and display of this function is, of course, integrated in CEBIS.



The power you need
with the fuel savings you like.

CPS | CLAAS
POWER
SYSTEMS

Our driving force: the interplay of select components.

Your CLAAS machine is much more than the sum of its individual parts. Top performance is only possible when all the parts are ideally matched and work together optimally.

In CLAAS POWER SYSTEMS (CPS), we have brought together select components to create an intelligent drive system that sets new standards. Full engine output only when you need it. Drives that are suited to the way your machines are used. Fuel-saving technology which quickly pays off.



Its drive is brilliant.

Power used efficiently.

The highly efficient JAGUAR drive system impresses through its simplicity. The chopping mechanism is driven directly by the engine via a long, maintenance-free powerband.

- The COMFORT CUT precompression roller drive is integrated in the main drive.
- The whole feeder unit is designed for maximum reliability, outstanding durability and a long service life, with rugged drives, large bearings and gears.

- The front attachments are connected to the JAGUAR by means of a quick-release coupler and can be driven in standard, split-power or variable mode. A second, independent front attachment drive can be used for the reel of the PICK UP.
- The crop accelerator can be run with a high discharge capacity or, to save energy, with a wider clearance setting.



Five characteristics that deliver efficient performance.

- 1 Transverse-mounted engines
- 2 Direct powerband drive from engine to
 - Chopper unit
 - Accelerator.
 - COMFORT CUT
 - Front attachment drive
- 3 Direct powerband drive from accelerator to corncracker
- 4 QUICK STOP brings the crop flow to a halt quickly when the main drive is disengaged
- 5 Four possibilities for the front attachment drive: constant, variable, split-power or two independent variable drives



More throughput. Less fuel.

- The JAGUAR main drive: direct, powerful, robust and requires little maintenance
- The drive system: a highly efficient design



Up to 925 hp
to get the job done.

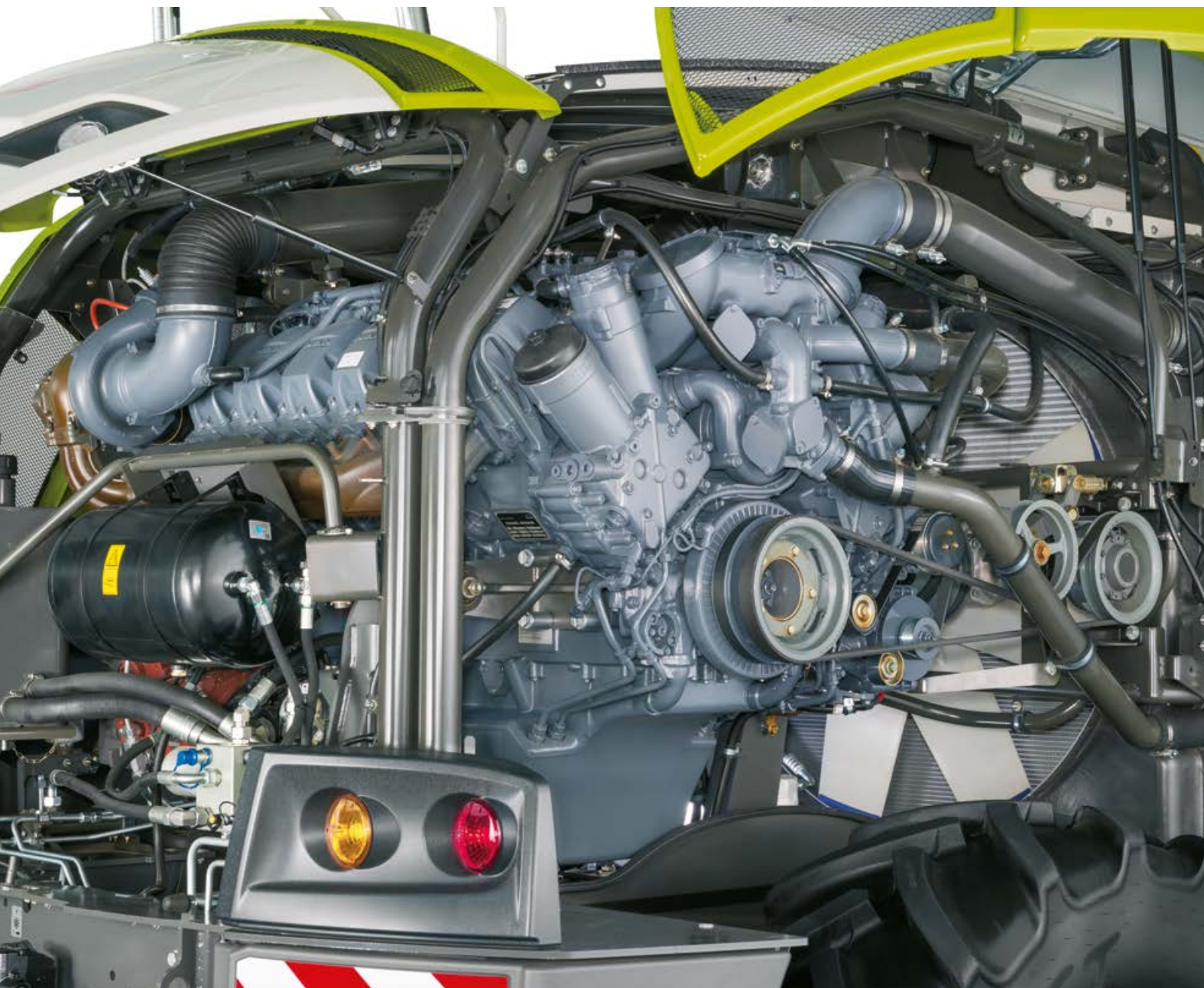

Power and intelligence from
MAN and Mercedes-Benz.

The JAGUAR 990 and 980 models are equipped with the MAN D2862 V12 engine with outstanding torque delivery. New to the line-up is the MAN D4276 in-line six-cylinder unit for the JAGUAR 970. The 960 and 950 models are equipped with the OM 473 LA while the 940 has the OM 460 LA. All the engines are notable for their excellent reliability, high efficiency and economical fuel consumption.

With 925 hp, the JAGUAR 990 is the top model of the new generation.

- Low fuel consumption
- Large tank capacity
- Very smooth running
- Optimal accessibility
- Effective, rotary dust and dirt-particle extraction
- DYNAMIC COOLING variable fan drive
- Long maintenance intervals of up to 1,000 operating hours
- Effective cooling through large surface area of radiator screen

High engine output – JAGUAR 990.

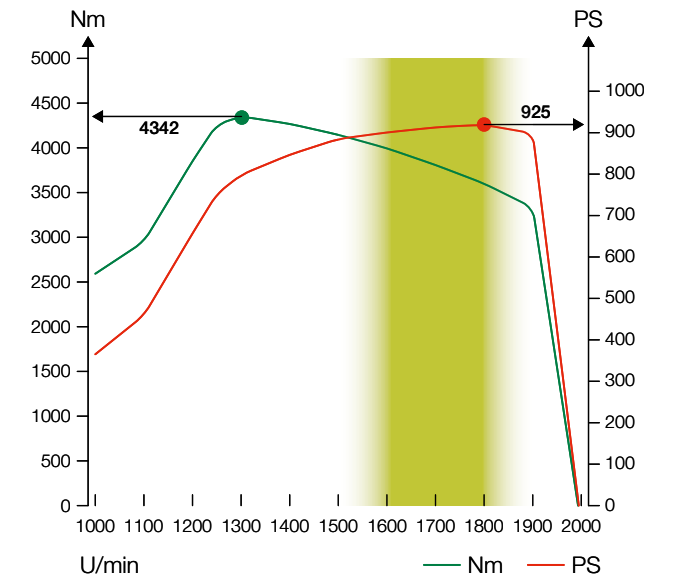

JAGUAR engines	Type	Stage IIIA (Tier 3)		Displacement litres
		kW	hp	
990 with MAN V12	D2862	680	925	24.24
980 with MAN V12	D2862	625	850	24.24
970 with MAN S6	D4276	581	790	15.90
960 with MB S6	OM 473 LA	480	653	15.60
950 with MB S6	OM 473 LA	400	544	15.60
940 with MB S6	OM 460 LA	360	490	12.82



MAN V12 D2862



Mercedes-Benz OM 473 LA



Mercedes-Benz OM 460 LA

High-capacity fuel tank



JAGUAR	Fuel tank	Auxiliary fuel tank	Fuel, total
990-940	1200 l	300 l	1500 l
HVO ready		990-950	



NEW: Sustainability.

For the first time, the machine is supplied ex factory filled with HVO fuel (DIN EN 15940). Hydrotreated Vegetable Oil is a synthetic diesel fuel whose pollutant emissions are lower than those of fossil-based diesel as it is free of various pollutants, such as aromatics and sulphur compounds.

Characteristics:

- Equivalent fuel consumption
- HVO and diesel are fully miscible
- Reduced engine noise and smoother combustion
- Reduction in CO₂-emissions

Putting the power down where it's needed.

Front axle with double hydrostatic motor.

The JAGUAR is equipped as standard with a double hydrostatic motor at the front axle. It has a wide speed range and pulls away powerfully on the road, in the field and on slopes. Its two-speed gearbox not only gives it plenty of tractive power, but also allows it to reach speeds of up to 40 km/h.

The wheeled machine is capable of speeds of up to 22 km/h in first gear. This increases its operational flexibility and makes for greater comfort and convenience during field work. Automatic engine speed reduction saves fuel and reduces engine noise with speeds dropping as low as 1,400 rpm when turning at the headland and even 1,200 rpm when stopping for a trailer changeover. During road travel, the engine speed is reduced to as little as 1,290 rpm.

Limited slip differential lock with three settings.

For improved traction, you can simply lock the drive axles by means of a multi-disc clutch. You have a choice of three settings:

- 1 The automatic engagement system recognises when a wheel on the drive axle is slipping and locks the front axle automatically. This setting is recommended when harvesting with AUTO PILOT.
- 2 The automatic disengagement system normally keeps the clutch closed. It opens it again if the speed exceeds 15 km/h, if there is a steering input or if braking occurs.
- 3 Manual engagement is suitable for short-term use in very heavy-going and difficult terrain.

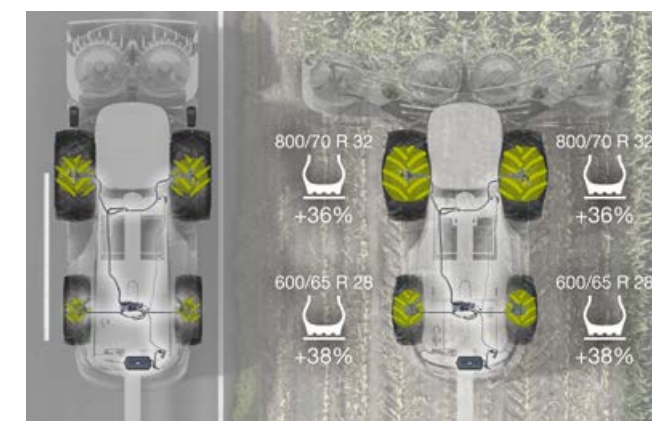

Tyre pressure control system for greater soil protection.

When operating on ground that's wet or which provides poor traction, you can adjust the tyre pressure accordingly (optional feature). Furthermore, adjustment for road travel and field work takes place automatically. Reduced tyre pressure means that the machine is very gentle on the soil while delivering maximum traction and reducing your fuel consumption by up to 5%¹.

Automatic parking brake for enhanced safety.

If the multifunction control lever is in the neutral position, the parking brake is actuated automatically when the machine comes to a standstill. This prevents it from rolling away unintentionally on a slope. Furthermore, you can change gear comfortably without having to use the brake pedal. With the automatic parking brake function deactivated, front attachments can be coupled easily thanks to the very sensitive pull-away response.

¹ Field study by the South Westphalia University of Applied Sciences

POWER TRAC for more tractive power.

If you are operating the JAGUAR in classic two-wheel-drive mode and engage the POWER TRAC four-wheel drive, you benefit from up to 40% more tractive power. When harvesting with the PICK UP, the traction of the steering drive axle is reduced automatically.

Large tyres for high ground clearance.

On standard tyres, the JAGUAR has a ground clearance of up to 450 mm. If you wish to have even greater ground clearance, you can specify the optional, large tyres: these have a maximum size of 900/60 R 38 and a diameter of 2.05 m at the front and a maximum size of 620/70 R 30 at the rear.

Rear axle geometry for tight turning radius.

The tilted rear axle geometry allows the JAGUAR to be manoeuvred easily and, depending on the tyres fitted, gives it a turning radius of as little as 12.50 m.

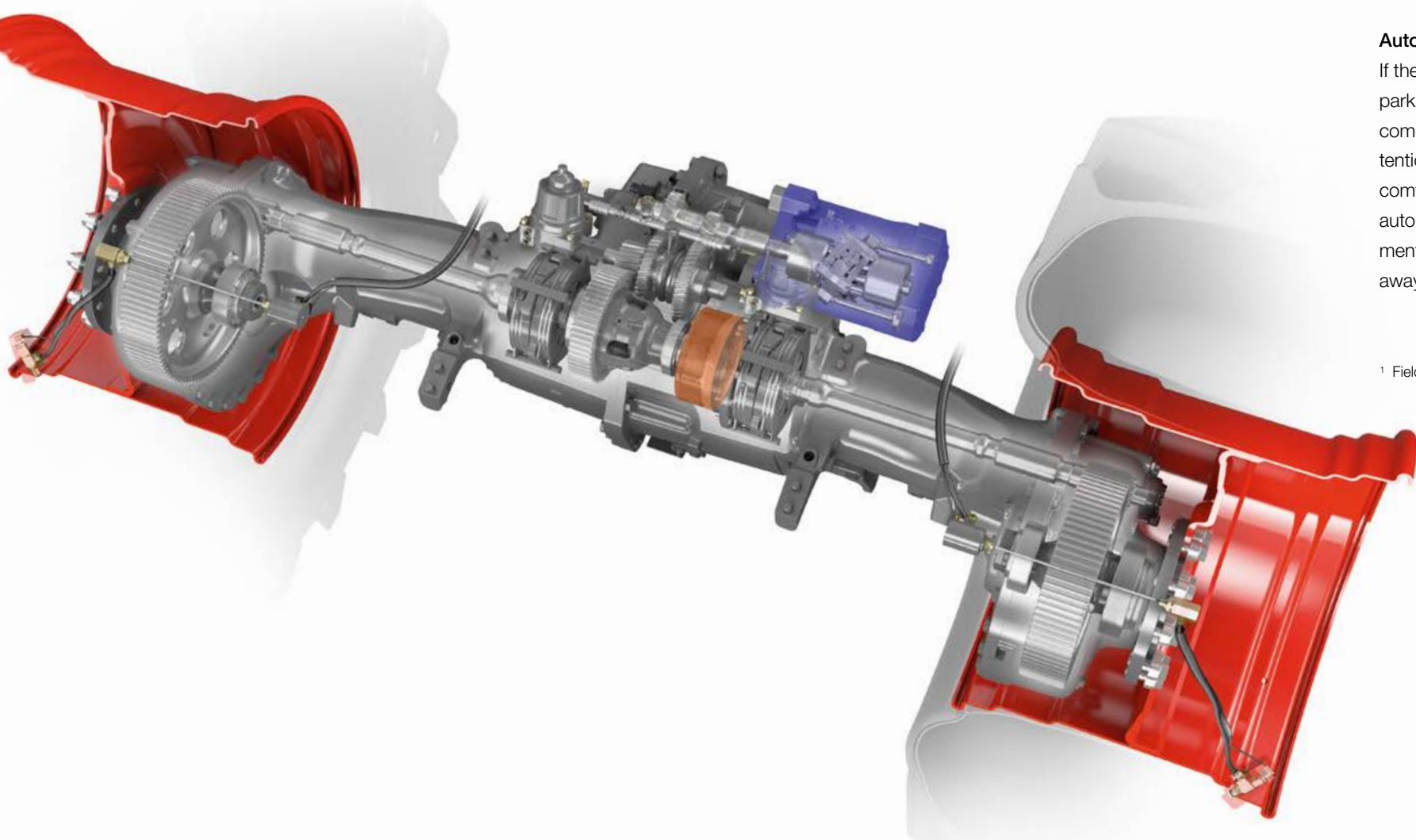



There is nothing to distract you.

You will find that you can operate the JAGUAR intuitively in next to no time. The low noise level in the cab and the optimal view of the field allow you to concentrate fully on the task in hand while the steering column and operator's seat can be adjusted to meet your requirements precisely.

Key functions are controlled by means of the CMOTION multifunction lever and a small number of central controls which are laid out logically. All machine functions can be accessed quickly and easily via the CEBIS touchscreen.



Respond faster via the touchscreen.

The JAGUAR can be operated without previous knowledge. This means that even new operators can quickly handle the machine safely and reliably and make use of its performance capacity.

The touchscreen CEBIS gives you fast access to all the machine functions. The most important adjustments can even be made directly by means of switches on the armrest. Precise operation is ensured under all conditions, whether it's a question of a bumpy ride across a field or an operator who is just getting used to the system. You can adjust and operate the JAGUAR in four ways, as required.

A JAGUAR fits the way you work perfectly.

- The clear menu system provides scope for personalised display options.
- Fast access is made easy by the CMOTION control lever.
- The position of the monitor can be adjusted as required for an optimal view.



1 CEBIS touchscreen.

CEBIS responds immediately to a simple tap on the touchscreen. You have direct access to all the machine functions – such as CEMOS AUTO PERFORMANCE.



2 CMOTION favourites management.

Seven settings can be programmed as favourites and accessed by rocker switches on the CMOTION control lever. You can therefore concentrate on watching the front attachment and crop flow.



3 CEBIS rotary/push switch and pushbuttons.

Even when operating in bumpy terrain, you can easily navigate the CEBIS control panel using rotary/push switches and the Escape and Favourites buttons – e.g. to adjust the shear bar.



4 Direct adjustment via switches.

You operate predefined basic functions directly by means of assigned switches – e.g. to adjust the working width with the section switch.

A cab that's a pleasure to work in.

The clear and intuitive controls make for easier harvesting, even on long working days. The choice of user-friendly entertainment and communication systems makes work seem almost like a hobby.



NEW: Hands-free functionality, navigation, playing music – in combination with Apple CarPlay / Android Auto, the sound and entertainment package makes work more enjoyable. The subwoofer gives the sound the right depth and forceful bass delivery.

CLAAS offers preparation for installation of these items as an additional equipment option. It is then simplicity itself for your CLAAS distributor to retrofit the cab with a radio with a 6-inch touchscreen.



NEW: Everything you need for easy, high-quality communication and entertainment is provided.

- The DAB+ radio guarantees clear reception of national stations
- The gooseneck microphone ensures that you are heard loud and clear
- No need to plug your phone in to recharge thanks to the inductive charger

- Charging is also possible via the additional USB-C ports
- Large cupholders are on hand for your drinks
- Any sand or dust that gets into the cab can be cleaned out quickly with the integrated compressed-air gun

Intuitive and comfortable,
our quietest cab.



Your workplace in the JAGUAR.

In the JAGUAR, there is simply nothing to distract you. You have the space you need, are shielded from noise and have a clear view all-round.

- Spacious cab with two seats
- Excellent seating comfort with a choice of comfort seat, leather seat or heated and ventilated premium seat
- LED work lights (characteristics similar to daylight) on cab roof, at the rear and on the discharge chute for optimal monitoring of harvesting operations

Developed for extended working.

- Very quiet and spacious workplace
- Simple, intuitive operation
- Very good view in the field and on the road
- Equipped to a high standard for high comfort



Ergonomic comfort cab.

The steering column and operator's seat can be adjusted to suit each and every operator. Thanks to the clearly laid-out displays and controls, you will feel at home in the JAGUAR in no time.



Wide range of equipment variants.

Roller sunblinds, air conditioning, a radio and a coolbox help to keep you fresh and alert, no matter how long you are on board.



Good communication.

The radio tuning and volume controls as well as those for the telephone (via Bluetooth) are integrated in the armrest.



Lighting as bright as day.

LED work lights on the cab roof and at the rear turn night into day for you. The LED spotlight on the discharge chute pivots with the crop flow. NEW: optional LED road lights.

Designed for a pleasant working experience that also saves time and fuel.

Make life easier for your operators.

Although they vary depending on the individual farm and task concerned, the demands made on operators can be very high and are constantly increasing. CLAAS operator assistance systems have been developed to make your operators safer and more proficient, to make your harvesting run more smoothly and to reduce your costs. As a result, you are able to make more efficient use of the JAGUAR throughout the whole working day.



We have an outstanding support team for you.



DLG silver award for CEMOS AUTO PERFORMANCE.

CEMOS is the CLAAS Electronic Machine Optimisation System, within which CEMOS AUTOMATIC groups together all the functions which automatically optimise the machine and a particular process. CEMOS AUTO PERFORMANCE is an intelligent engine management and ground drive concept for the JAGUAR which was awarded a DLG silver medal.

With CEMOS switched on, you can harvest even more efficiently – an improvement in the area/hour (ha/h) rate of up to 7% with a 12% fuel saving is possible. In order to increase efficiency and reduce fuel consumption, the JAGUAR maintains the engine speed set by the operator and adjusts the engine output and ground speed in accordance with the volume harvested. When the volume harvested increases, the ground speed is reduced. A reduction in the volume harvested results in the automatic reduction of the engine output.

Five advantages of CEMOS AUTO PERFORMANCE:

- A consistent engine speed for a consistent harvesting process
- Even crop flow for highly reliable operation
- Lower fuel consumption as a result of operating in an efficient engine speed range, especially under partial load
- Pleasant driving characteristics without sudden load changes
- Operator's workload is reduced in demanding harvesting situations



Experience CEMOS AUTO PERFORMANCE at work during harvesting.

Scan me.

Easy operation with the CMOTION control lever.

CEMOS is activated via the practical dual-function Auto button. First, a single press of the button switches on the automatic steering system. Once the machine has driven into the crop, CEMOS can be activated by a second press of the button. With the machine now in the crop, CEMOS is able to configure it more rapidly to ensure stable performance in the optimal operating range.

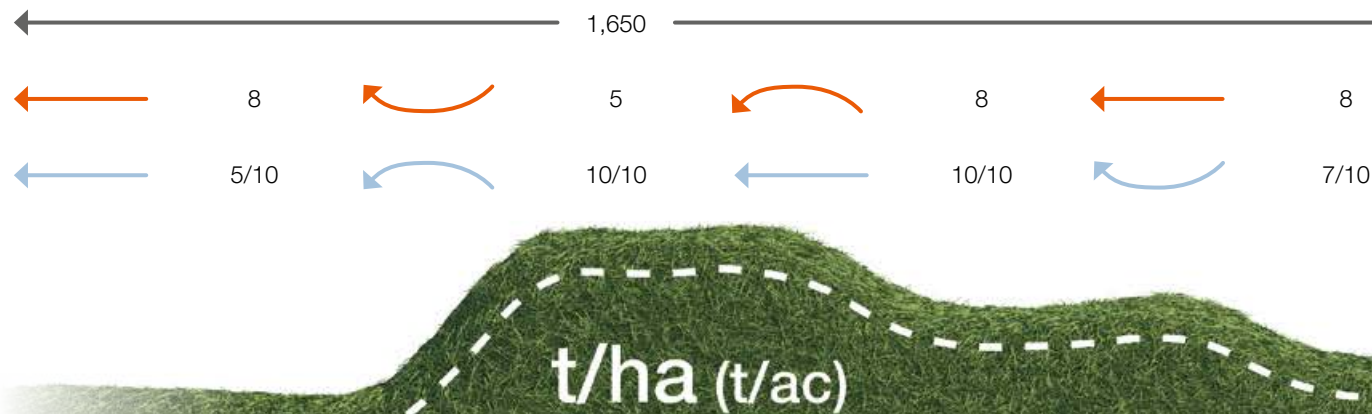

Steering assistants for outstanding harvesting precision.

Easy steering.

Precise steering is decisive for the efficiency of your entire harvest operation. Enhancements to steering systems can even enable dynamic steering and so significantly increase driving comfort when turning at the headland. Automatic steering systems, such as CAM PILOT, AUTO PILOT and the satellite-based GPS PILOT can greatly reduce the burden on your operators.

Dynamic steering for the JAGUAR.

The machine takes about five steering wheel turns to go from lock to lock. However, many operators prefer a reduced steering effort when they have to turn at the end of the field. The dynamic steering system makes it possible to go from straight-ahead running to full lock in only $\frac{2}{3}$ of a steering wheel turn when travelling below 10 km/h. The intensity of the dynamic steering response can be adjusted as required in CEBIS. The system allows individualised settings to be programmed, with different responses possible on the basis of whether the front attachment is in the working position or not.



Vision-based with CAM PILOT.

The CAM PILOT assumes control of steering the JAGUAR in combination with the PICK UP. The swath is detected as a three-dimensional image by a twin-lens camera. Corresponding signals are transmitted to the steering mechanism in the event of deviations in the swath shape or direction. The steering axle then responds to these steering commands. This makes for reduced operator workload at speeds up to 15 km/h.



Sensor-based with AUTO PILOT.

Row-independent maize front attachments also usually follow maize in rows, a task in which they are assisted by the AUTO PILOT. Two sensor arms each scan a row of maize. The signals they generate are translated into corrective steering impulses. Twin-row sensing allows automatic steering in row widths from 37.5 cm up to 80 cm.



CEMIS 1200 terminal with intuitive control.

You can count on the support of the CEMIS 1200 terminal for precision GPS tracking.

Satellite-based with GPS PILOT.

The GPS PILOT uses satellite signals to steer the JAGUAR reliably and with unbeatable precision along parallel tracks, curved contours at the crop edge, or reference lines defined by the operator. It is possible for the operator to make use of the full working width and to reduce overlaps to a significant degree. Unaffected by light conditions, it works at night or in low visibility just as precisely as it does in full daylight. You receive correction signals for whichever degree of accuracy you require. Existing GPS track lines in ISO XML format — produced by a swather during grass harvesting or generated during maize sowing, for example — can be used with the GPS steering system of the JAGUAR.

- The brilliant 12" display is easy to read by day or night.
- All the relevant functions can be accessed quickly via the touchscreen.
- You can adapt the working areas in line with your requirements and configure them freely.

Antenna and receiver are housed together in the roof unit. The SAT 900 GNSS receiver is provided with SATCOR 15 by Trimble RTX as standard.

- 5-year licence for use of SATCOR 15 by Trimble RTX
- Pass-to-pass accuracy +/- 15 cm
- Pass-to-pass accuracy as high as 2 cm is available as an option



SAT 900 antenna and receiver in one unit – with anti-theft protection

Find out more about the factory-integrated GPS PILOT and how you can benefit from it. steering.claas.com



Scan me.

Only an automatic system can fill a trailer as reliably as this.

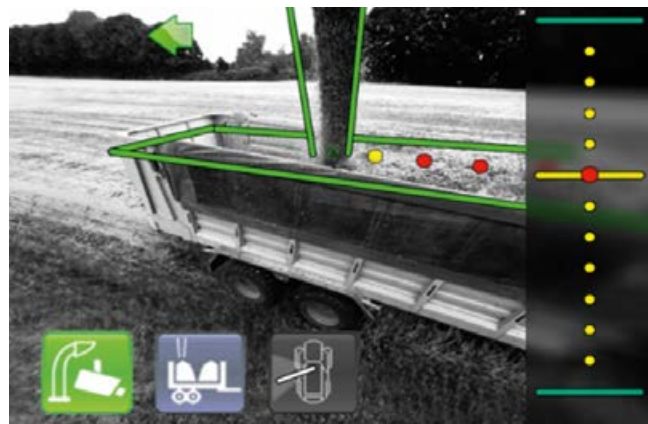

AUTO FILL for automatic trailer filling.

AUTO FILL is based on digital 3D image analysis. The system takes care of controlling the position of the discharge chute to the side or the rear. In chopping start-up mode, you choose the direction in which discharging is to take place. For automatic filling to the rear, only the desired impact point needs to be specified. In crosswinds or on steep slopes, the impact point can be corrected. You can always see the target impact point indicated on the AUTO FILL camera image.

OPTI FILL for maximum operating convenience.

The optimised chute control system makes it easy to manage the discharge process, even without AUTO FILL. A large swivel angle of up to 225° ensures that you have an optimal view of the process. When the discharge chute is swivelled, the end flap is adjusted automatically in such a way that the discharge takes place parallel to the direction of travel.



Two permanently programmed chute positions simplify the swivelling process at the end of the field. The discharge chute can also be returned to its parking position automatically at the touch of a button.

NEW: Indication of impact point for side discharging.

When the machine is discharging to the side, the operator is given a virtual indication of the impact point of the harvested material. In automatic mode, the discharge stream can target the impact point for efficient trailer filling.



NEW: Trailer changeover while on the move.

An exclusive function allows the operator to change to a different discharge trailer while AUTO FILL is running. This function is triggered by double-clicking the AUTO FILL button. The end flap opens at a preset angle so that the crop stream is directed accurately to the empty trailer running alongside. While this is happening, AUTO FILL is in standby mode and is reactivated by the operator as soon as the fully laden trailer is no longer picked up by the camera.



Rear discharging.

If there is a changeover from side discharging to rear discharging, as a result of a change of chopping mode, for example, the operator only has to define the impact point by actuating the discharge chute flap.

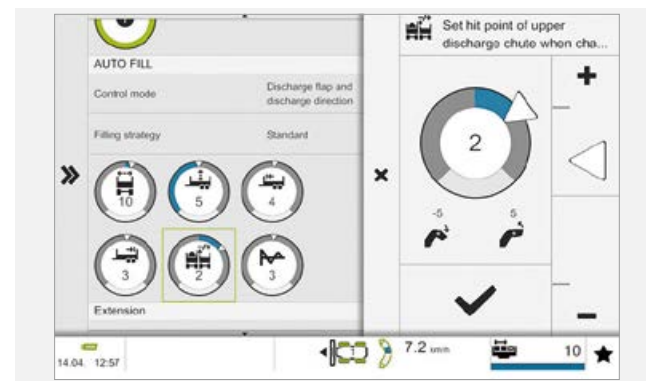
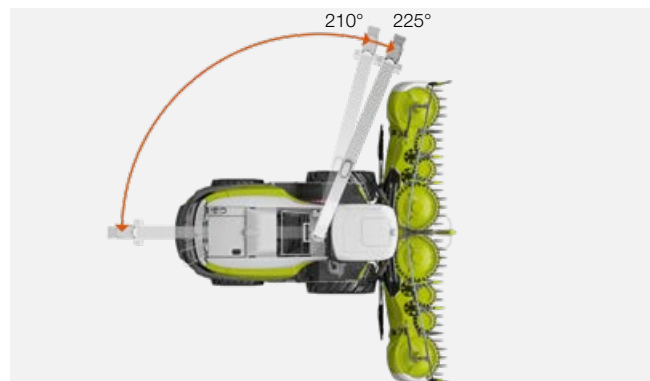

Avoid operator stress and losses.

- Automatic filling of transport trailers to the side and rear reduces the operator's workload
- Video display with symbols - indicating the position of the discharge chute, for example
- Accurate guidance of crop stream when changing trailer

Precise yield registering with measurement of throughput and constituents.

Practical data management is essential.

Data have long since become an indispensable resource. To profit from their full potential, you should always keep a close eye on the results and know how you can make use of them effectively.

Online registering of the crop yield, moisture content and constituents by means of the QUANTIMETER and NIR sensor plays an important role in documenting your machine activity. In order to achieve this, you should ensure that all the systems, machines and work processes are connected in such a way as to provide useful results. The data generated are sent to many different places for analysis.



QUANTIMETER.

Determining the throughput.

The deflection of the precompression rollers is registered and the volume flow measured continuously. Corresponding calibration by counterweighing allows you to achieve a very high degree of accuracy in measuring the throughput. NEW: The calibration status is displayed to the operator in CEBIS.

DLG test results.

In 38 measurement runs, a deviation of only 0.2% was determined in DLG Fokus Test 6168 F. Continuous dry matter measurement increases the accuracy of the current throughput measurement.



Advantages for you:

- Transparent harvest data for every machine deployment
- No overloading of forage trailers
- Precise data as basis for source stream accounting and fertiliser ordinance



NIR sensor.

Determining the dry matter.

The measuring procedure using near infrared spectroscopy runs continuously during the harvesting process. A light source in the upper discharge chute is directed at the crop as it flows past. The light is reflected back in different ways, depending on the crop moisture level.

DLG test results.

DLG tests certify a deviation in dry matter content of less than 2% in 95% of the measurements in maize and 88% of the measurements in grass. No test sample displayed a deviation of more than 4%.



Advantages for you:

- Basis for invoicing by dry matter content
- Silage additive dosage and length-of-cut control can be carried out automatically in accordance with the dry matter content
- The forage quality is already registered during harvesting

NIR sensor.

Determining dry matter and constituents.

As well as providing dry matter data, the NIR sensor provides information about the constituents of different crop types. For example, the value determined for the crude ash content can be used as an indicator for setting the raking height of the LINER.



Advantages for you:

- Reliable indicator of forage quality
- Quality of different varieties supports decision-making during cropping planning, e.g. on basis of starch content

A connected JAGUAR is more productive.

Digitalisation pays.

Intelligent digitalisation matched to the requirements of your farm reduces your workload and increases your productivity. Data generated in completely different places can be collected and evaluated centrally. This conserves your resources and improves your farm operations.

To enable you to get more out of the JAGUAR and your other machines, CLAAS offers a range of modules which allow systems, technology and working processes to be connected with each other, regardless of the manufacturer.

Forward planning in the office.

- Prepare jobs including reference tracks and transfer them to CEMIS 1200

Optimisation on the machine.

- Create and manage all jobs directly on the machine with CEMIS 1200
- All job data are documented online as an automatic background operation
- Transmit data from different manufacturers' products into the cloud smoothly
- CLAAS Connect includes a silage additive calculator for consistent and precise dosage on the basis of the type of additive and crop.
- Save valuable maintenance and service time with remote diagnostics

Detailed assessment in the office.

- Transfer and document job and harvest data quickly
- Analyse fields easily and map yields precisely
- Assess work processes intensively and identify scope for improvement
- Analyse forage quality through content measurement

CLAAS connect links you up with CLAAS.

CLAAS connect links people, machines and systems. This app helps you keep track of your machine fleet and check the most important telemetry data. It is also the quick way to find the right operator's manual, lubricants and parts for your machine.

Keep track of your service contracts and licence agreements. You also have access to many other CLAAS applications.

Machine connect links your JAGUAR into the network.

Machine connect allows you to use the full scope of CLAAS connect. It gives you a real-time overview of the tank fill levels, the location, the operating hours and maintenance dates. You also benefit from other digital CLAAS services, such as CLAAS TELEMATICS and MAXI CARE connect. With CEMIS 1200 and Machine connect you can take care of job management tasks on the machine itself and transfer the data online to TELEMATICS, 365FarmNet or other connected systems.

TELEMATICS records your success.

Work data, tracks and yield data can be retrieved and recorded continuously by means of TELEMATICS. All data are transmitted via the mobile phone network from the machine to the server, where they are processed and stored. You can access and evaluate your data online in real time or retrospectively via the TELEMATICS portal or the app.

DataConnect, developed by CLAAS, 365FarmNet, John Deere, Case, Steyr and New Holland, is the first direct multi-manufacturer and industry-wide open cloud-to-cloud solution. It allows you to control and monitor your entire machinery fleet in the CLAAS TELEMATICS portal.



Connected documentation collects your harvest data.

With the "CLAAS Connected Documentation" licence, the harvest data, including the content of the crop, are automatically collected and assigned to the fields which have been worked. This functionality requires that your field boundaries are specified in the system, either before or after the harvest. Subsequent documentation of any extra areas which happen to be harvested means that no data are lost. Data can be exported to all the current farm management programs at any time.

MAXI CARE connect simplifies servicing.

MAXI CARE connect plays an important role in ensuring the operational reliability of your machines. It simplifies maintenance and service support for you significantly. The machine informs the service partner of an upcoming requirement for maintenance or sends immediate notification if a fault arises. The service partner therefore has access to the relevant data and can prepare optimally for the intervention in both scenarios.



CLAAS NIR sensor. When you want to know exactly what you're dealing with.



Sensor-based values (constituents)	Grass	WCS	Maize
Dry matter	●	●	●
Moisture	●	●	●
Starch	–	●	●
Crude protein	●	●	●
Crude fibre	●	●	●
Crude ash	●	●	●
Crude fat	●	●	●
Sugar	●	–	–

● Standard – Not available

People and machines you can count on.

Keep downtime to a minimum.

Operating the JAGUAR, you benefit from extremely wear-resistant components which make your machine even more reliable. And from a well thought-out maintenance concept that saves a lot of time. From practical details, like the standard compressed-air system which makes cleaning the machine easy. And from the dedicated mechanics of the CLAAS service team, who are there for you 24 hours a day.



Its reliability
is your strength.



Our solutions address your needs in detail to improve your operating reliability.

It is often the case that every minute counts during the harvesting period. Time-consuming maintenance work is a nuisance and also a cost factor as it reduces the number of productive hours – and also the profit margin.

Reliable machines are the backbone of your business. That is why the JAGUAR is designed for high reliability, outstanding durability and a long service life. In order to ensure that you can count on your machine in every phase of the harvest, we examine every detail and pursue a policy of systematic development.

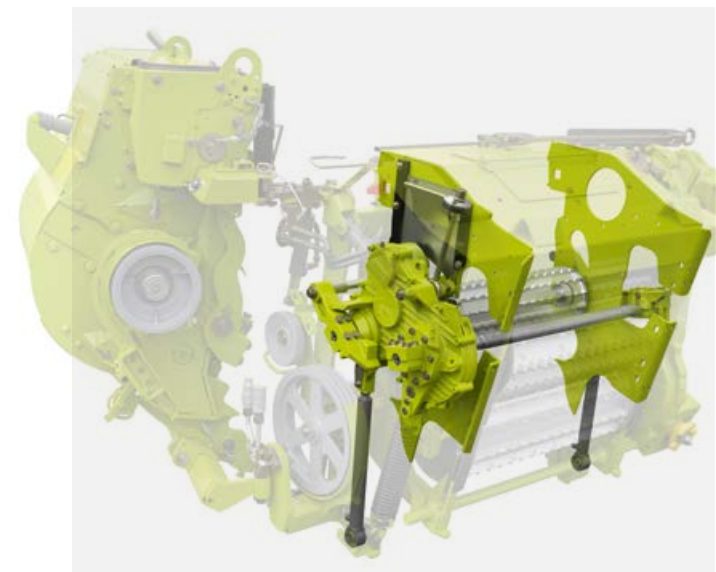

Feeder housing optimised.

- Hydraulic precompression as a standard feature is exclusive to the JAGUAR.
- The reinforced feed roller is designed for high throughput.
- Larger sliding plates on the sides of the pre-compression rollers reduce dirt and noise.
- Maintenance is facilitated by the use of clamps to secure the rollers.

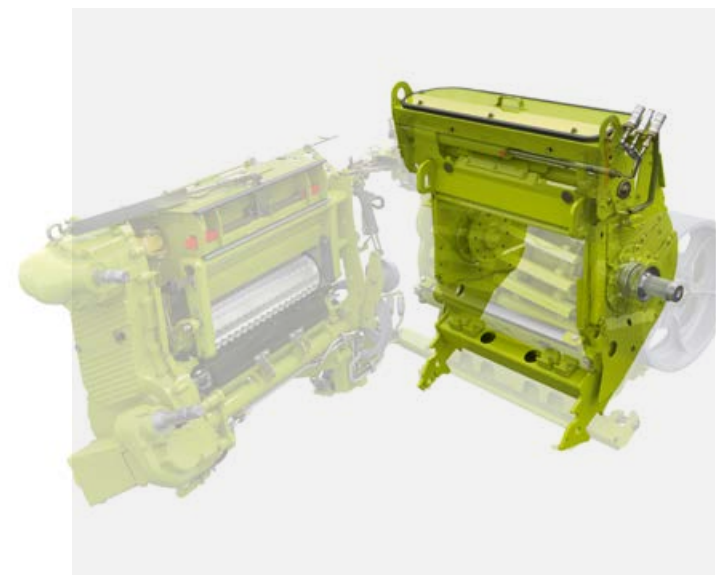

Chopping cylinder housing perfected.

- The service life of the chopping cylinder bearings has been doubled.
- The significantly improved sealing of the sharpening system reduces dirt ingress and noise.
- Flat-face couplings simplify maintenance of feeder housing and chopping cylinder housing.



Discharge chute rotation ring reinforced.

- Large gear wheels make for high reliability.
- The rotation ring on the discharge chute has been reinforced.
- Wear-resistant, long-lasting material increases operating reliability.

A JAGUAR is quick and easy to maintain.



The seat contact switch automatically switches off the front attachment and main drive



LED step lighting for safe access to the comfort cab



QUICK ACCESS lets you inspect the chopping unit in a matter of minutes

Maintenance lighting as bright as day.

- LED maintenance lighting under the side and rear panels as well as in the stowage compartment
- Hand lamp with magnetic base for front illumination
- LED homefinder light function for work lights after ignition is switched off
- LED step lighting

For your safety and convenience.

- Leaving the operator's seat causes the front attachment and the main drive to be switched off automatically after 7 and 12 seconds respectively
- Spacious storage compartment for storing tools and accessories safely

A high-specification tool kit makes it easy to perform maintenance tasks.

Reliable service.

CLAAS MAXI CARE connect is ideal for fast problem resolution and proactive maintenance planning. On identifying a fault, the machine informs the operator and automatically sends an error message to the service partner. The service partner has access to all the relevant data, identifies the fault remotely and is able to prepare for the intervention to rectify it.

MAXI CARE connect makes periodic maintenance tasks much easier to schedule. The machine informs the CLAAS service partner of the upcoming maintenance requirement. The service partner suggests an appointment time for the maintenance to be performed and, depending on the scope of the maintenance, places an advance order for CLAAS ORIGINAL consumables.

MAXI CARE connect is a central element in the intelligent networking of your machines.

Everything to make maintenance easy.

Large side panels with two opening height detents for shorter or taller staff give you unrestricted access to the cooling system, the corncracker and the accelerator. QUICK ACCESS ensures that the chopping mechanism can be reached quickly and easily. If maintenance is required, the accelerator can be removed by two people in just one hour.

A maintenance-free brake system and long-life hydraulic oil also play their part in saving you time and money.



NEW: Automatic air hose reel.

Machine cleaning tasks are made particularly easy by the convenient 15-metre compressed-air hose which has an integrated auto-rewind reel.

User-friendly design makes for straightforward operation.

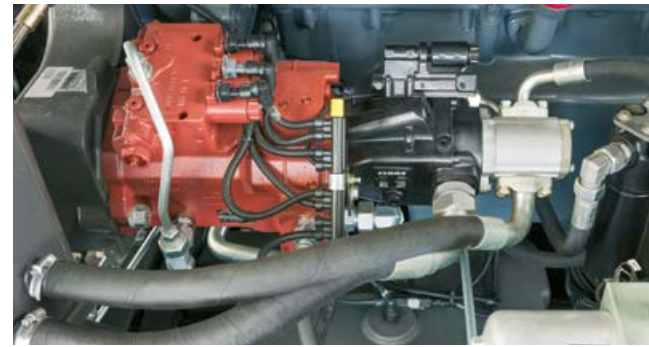

Clear hydraulics control.

The spool valves are clearly laid out on the left side of the machine. Proportional valves enable smooth control of the upper discharge chute and front attachments when these systems are functioning automatically. The raising/lowering speed and the speed of the lateral levelling system can be adjusted in CEBIS. This means, for example, that you can still obtain a consistent stubble profile with ORBIS, even when operating at high ground speeds.

- Rapid implementation of function commands
- Efficient control by proportional valves
- Low maintenance costs through low-volume oil system
- Hydraulic oil only needs to be changed after 1,000 operating hours
- Practical buttons outside the cab to stop/reverse the front attachment, raise/lower the front attachment and deploy/retract the ORBIS transport system
- Flat face couplings for fast coupling of hydraulic lines

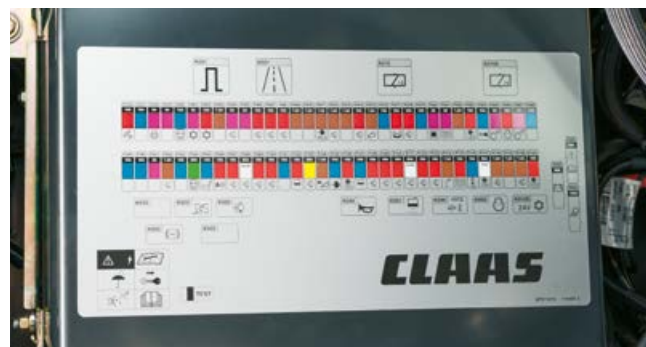
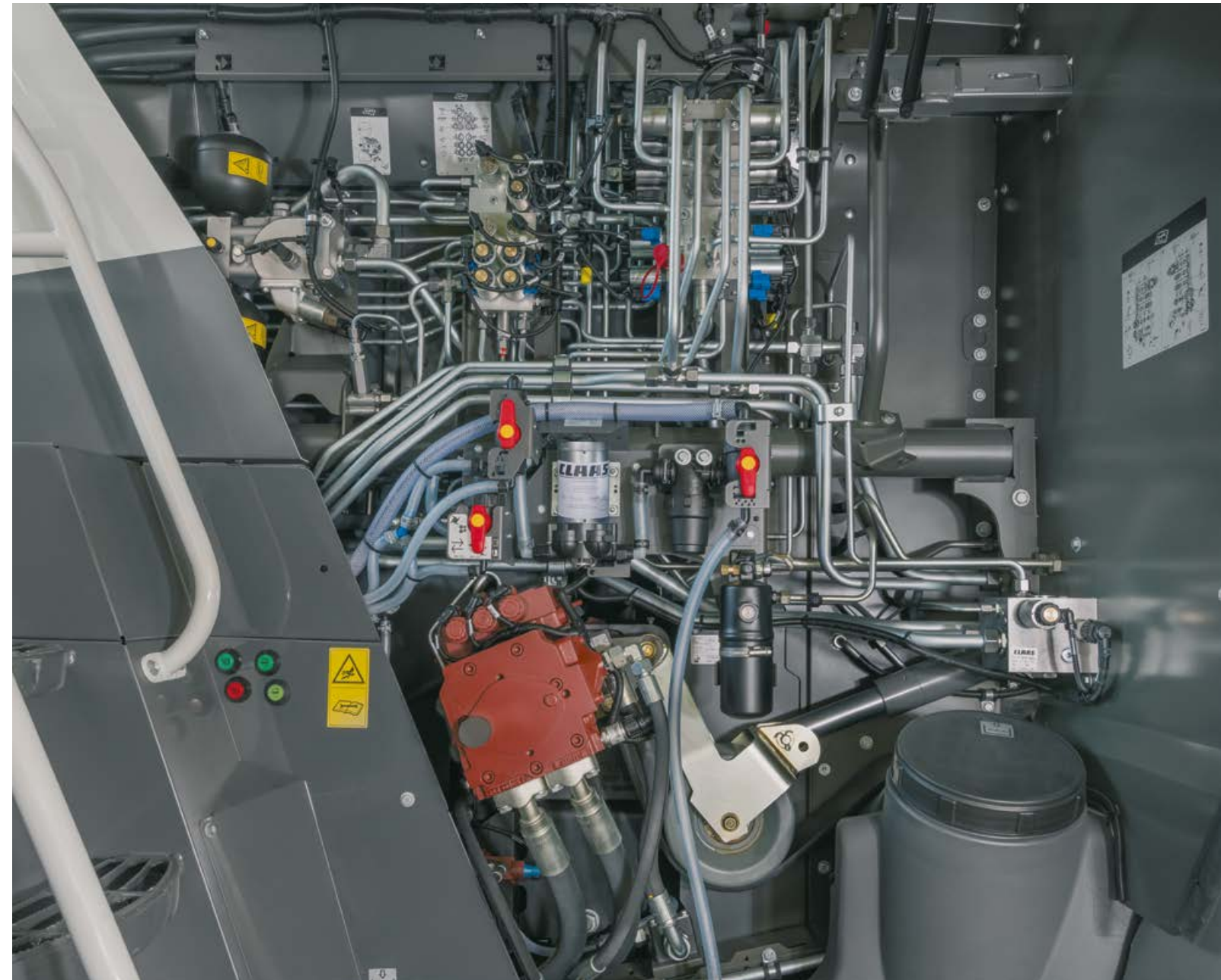

Easy-maintenance electrics.

A convenient control concept demands a fast, reliable electrical system. In the JAGUAR, all the key components are housed securely and centrally in the cab. An expansion box in the maintenance compartment of the JAGUAR allows you to retrofit additional options easily.

- PROFI CAM
- OPTI FILL and AUTO FILL
- ACTISILER 37
- NIR sensor
- Hydraulic precompression
- Variable front attachment drive
- Auxiliary fuel tank
- Accelerator gap setting
- Tyre pressure control system
- DYNAMIC COOLING

Automatic oscillation damping.

The hydraulically controlled oscillation damping system is activated automatically once the headland is reached and the front attachment raised past the working height. This additional convenience feature reduces wear and tear on the machine when crossing sprayer wheelings, for example. The front attachment is protected by a correspondingly gentle suspension response.



Sometimes you just have to get tough.



More operational reliability with PREMIUM LINE protection against wear.

Guaranteed performance level.

Even under the most demanding harvest conditions, CLAAS PREMIUM LINE parts provide very high wear resistance and a long service life. In many cases it is not necessary for them to be replaced until after several campaigns. This increased durability is made possible by special manufacturing processes, high-quality materials and special coatings.

PREMIUM LINE for ORBIS.

Highly wear-resistant parts are recommended for extreme operating conditions, where there is a high proportion of sand, for example, or extended periods of operation. A tungsten carbide coating ensures that the knives have a long service life. The speed difference between the cutting disc and the transport disc creates a self-sharpening effect.

The objective of the PREMIUM LINE concept is for the parts to achieve a service life which is at least twice or three times that of standard parts. Our practical experience shows that this objective is indeed attained. This is why we guarantee* a specified performance level for factory-fitted PREMIUM LINE parts on the basis of hours of usage or machine age.

The easily accessible cutting discs and transport discs have a modular structure comprising six segments. As a result, in the event of damage, you only need to replace the segment concerned, rather than the entire unit.

- 1 A special wear coating gives intake drums low wear characteristics
- 2 Interior guide strips made of steel (standard equipment)
- 3 Exterior guide strips made of steel
- 4 Wear elements to protect the large cutting discs
- 5 Knives with wear coating
- 6 Cover for deflector mounting
- 7 Small disc scraper
- 8 Scraper with deposit welding

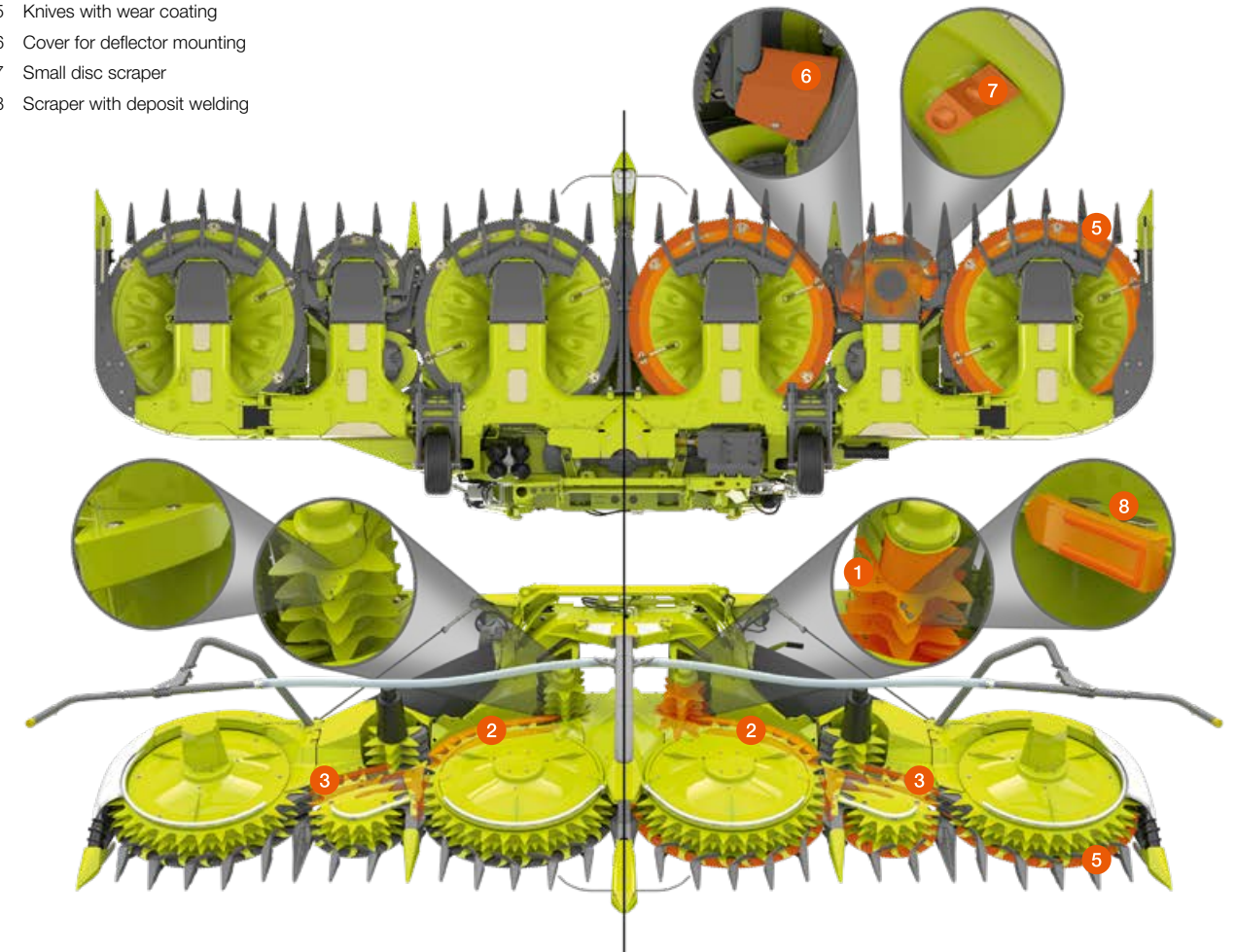

CLAAS PREMIUM LINE	Advanced	Professional
1 Feed roller toothed bars	–	●
2 Smooth roller stripper bar	●	●
3 Chopping cylinder concave	●*	●*
4 Vanes	●*	●*
5 Grass chute back panel	●*	●*
6 Accelerator paddles	–	●*
7 Accelerator housing, 2-part	–	●*
8 Accelerator housing, left /right sides	–	●*
9 Accelerator back panel	●*	●*
10 Lower discharge chute plate, front / rear	●*	●*
11 Discharge chute rotation ring plate	●*	●*
12 Wear plates of upper discharge chute	–	●*
13 First wear plate on upper discharge chute	●*	●*
14 Upper discharge chute flap	–	●

* The JAGUAR PREMIUM LINE Advanced and Professional packages give you a guaranteed operation warranty on all parts marked with*. This cover runs for five years or for a specified number of engine operating hours (whichever limit is reached first). For the precise number of hours, please see the JAGUAR product page which can be reached using the QR code above. Only available for selected countries.

● Available – Not available

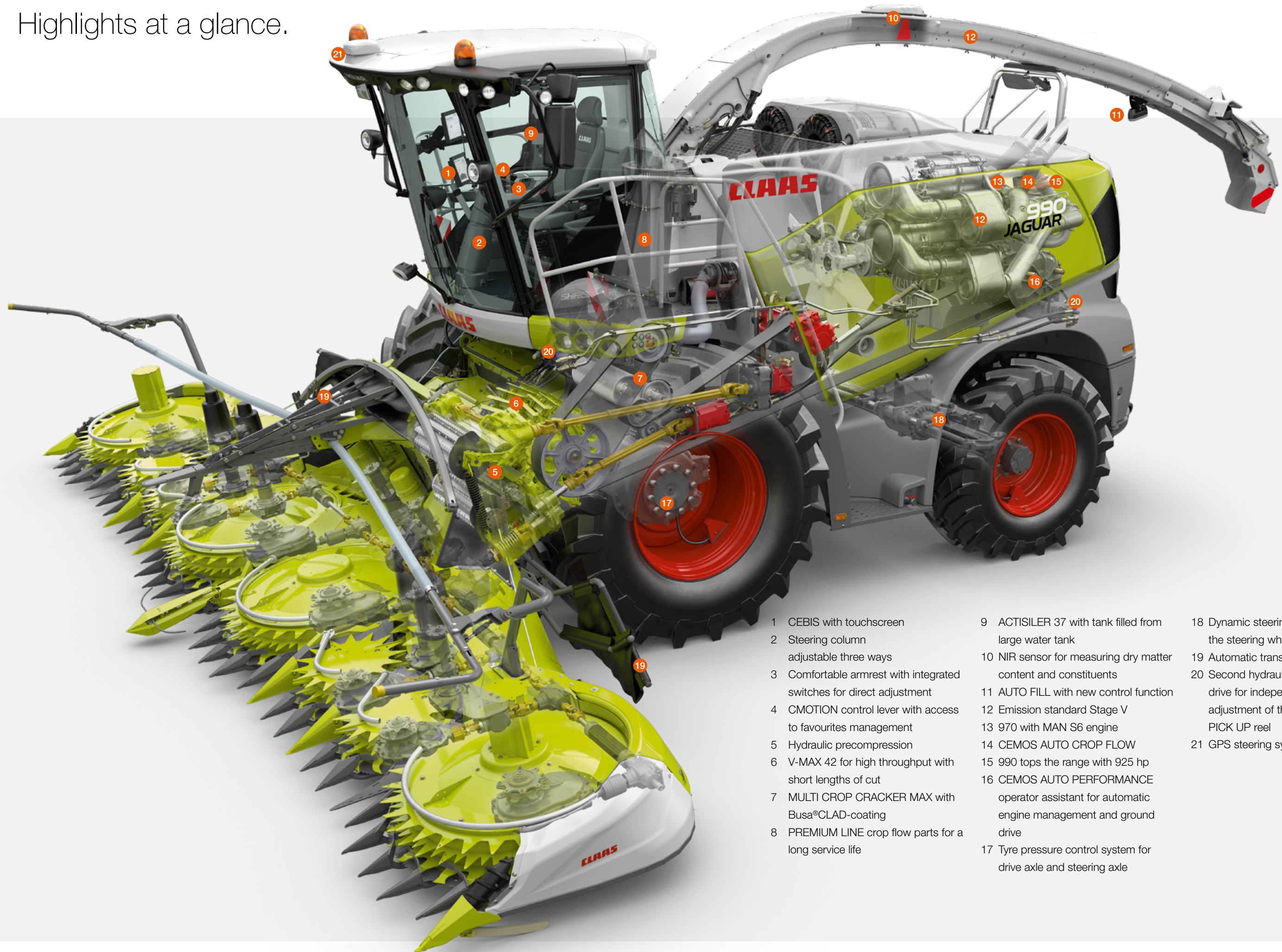

- | | | |
|--|--|---|
| <ul style="list-style-type: none"> 1 CEBIS with touchscreen 2 Steering column adjustable three ways 3 Comfortable armrest with integrated switches for direct adjustment 4 CMOTION control lever with access to favourites management 5 Hydraulic precompression 6 V-MAX 42 for high throughput with short lengths of cut 7 MULTI CROP CRACKER MAX with Busa®CLAD-coating 8 PREMIUM LINE crop flow parts for a long service life | <ul style="list-style-type: none"> 9 ACTISILER 37 with tank filled from large water tank 10 NIR sensor for measuring dry matter content and constituents 11 AUTO FILL with new control function 12 Emission standard Stage V 13 970 with MAN S6 engine 14 CEMOS AUTO CROP FLOW 15 990 tops the range with 925 hp 16 CEMOS AUTO PERFORMANCE operator assistant for automatic engine management and ground drive 17 Tyre pressure control system for drive axle and steering axle | <ul style="list-style-type: none"> 18 Dynamic steering for fewer turns of the steering wheel 19 Automatic transport protection 20 Second hydraulic front attachment drive for independent, variable adjustment of the speed of the PICK UP reel 21 GPS steering system CEMIS 1200 |
|--|--|---|

Whatever it takes – CLAAS Service & Parts.

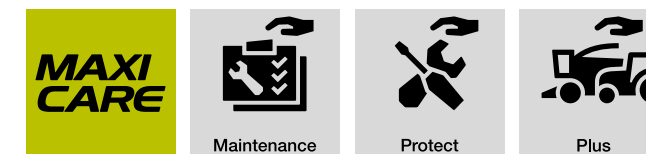

Safeguard your machine's reliability.

Increase your operating reliability, minimise the repair and breakdown risk. MAXI CARE offers you predictable costs. Create your own individual service package to meet your particular requirements.

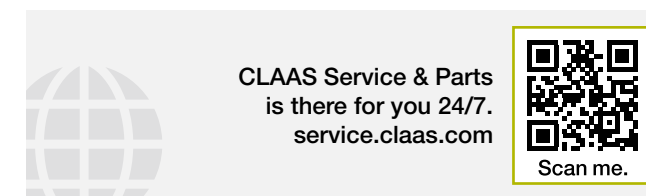

Specially matched to your machine.

Precision-manufactured parts, high-quality consumables and useful accessories. Choose our comprehensive product range to be certain of receiving exactly the right solution to ensure 100% operating reliability for your machine.



For your business: CLAAS FARM PARTS.

CLAAS FARM PARTS offers one of the most comprehensive ranges of multi-brand parts and accessories for all agricultural applications on your farm.



Global supply.

The CLAAS Parts Logistics Center in Hamm, Germany, stocks almost 200,000 different parts and has a warehouse area of over 183,000 m². This central spare parts warehouse delivers all ORIGINAL parts quickly and reliably all over the world. This means that your local CLAAS partner can supply the right solution for your harvest or your business within a very short time.



Your local CLAAS distributor.

Wherever you are, you can count on us to always provide you with the service and the contact persons you need. Your CLAAS partners are on hand in your local area, ready to support you and your machine around the clock. With know-how, experience, commitment and outstanding technical equipment. Whatever it takes.

Impressive advantages.



Crop flow.

- The crop flows in a straight line through the entire machine without any awkward angles.
- Variable front attachment drive and COMFORT CUT are integrated in the main drive train
- With 42 knives and 25,200 cuts per minute, the V-MAX 42 chopping cylinder is able to deliver particularly high throughput.
- The discharge chute enables reliable crop transfer up to a working width of 9 m
- Silage additive app makes it easy to use silage additives appropriately
- Water injection keeps the crop flow clean
- NEW: ACTISILER 37 with tank filled directly from the water tank

CLAAS POWER SYSTEMS.

- Optional second front attachment drive for PICK UP with independent drive of the reel
- The JAGUAR drive system is highly effective
- The MAN and Mercedes-Benz engines operate with up to 925 hp and a displacement of 24.24 l
- The automatic reduction in diesel engine speed by up to 1,200 rpm saves fuel
- JAGUAR 990 and JAGUAR 960 are also available with TERRA TRAC crawler tracks

Comfort and convenience.

- The CEBIS touchscreen gives the operator fast, easy access to all machine functions

- NEW: Increased cab comfort through gooseneck microphone, DAB+ radio, compressed air cleaning hose in the cab and much more
- Quiet cab
- The favourites management system can be operated conveniently and directly by means of the CMOTION control lever
- LED work lights with characteristics similar to daylight are positioned on the roof, rear and discharge chute to enable a good overview of machine operations
- NEW: Tool kit PLUS, high-specification tools for maintenance tasks
- NEW: Automatic hose reel with 15 m long compressed-air hose and air gun

Operator assistance systems.

- NEW: CEMOS AUTO CROP FLOW, crop flow stops automatically when engine reaches critical speed
- CEMIS 1200 satellite-based steering system. Find out more at steering.claas.com
- CEMOS AUTO PERFORMANCE increases driving comfort and efficiency while reducing fuel consumption
- Three different steering systems enable precise working and reduce the workload on the operators
- The dynamic steering increases driving comfort when turning at the headland
- AUTO FILL and OPTI FILL avoid losses when transferring the harvested material
- No need to get down from the cab when transferring from one field to the next with ORBIS and automatic transport protection.

JAGUAR 900	990	980	970	960	950	940
Cab						
CEBIS with touchscreen	●	●	●	●	●	●
A/C MATIC air conditioning	○	○	○	○	○	○
Printer	○	○	○	○	○	○
Comfort seat	○	○	○	○	○	○
Swivelling seat	○	○	○	○	○	○
Premium seat, ventilated, heated	○	○	○	○	○	○
Leather seat, ventilated, heated	○	○	○	○	○	○
Instructor's seat	○	○	○	○	○	○

Noise and vibration levels		990	980	970	960	950	940
Equivalent continuous A-weighted sound pressure level measured in various operating states, as per ISO 5131	dB (A)	71 ¹					
Vibration total value, as per standard EN 1032:2003	m/s ²	≤ 2.5 ¹					
Effective value as per standard EN 1032:2003	m/s ²	≤ 0.5 ¹					

Maintenance

Central lubrication system, 16-litre lubricant reservoir		○	○	○	○	○	○
Maintenance lighting		○	○	○	○	○	○

Dimensions and weights

Working length	mm	6495	6495	6495	6495	6495	6495
Working height with discharge chute extension XL	mm	6670	6670	6670	6670	6670	6670
Transport height	mm	3945	3945	3945	3945	3945	3945
Transport height with discharge chute extension XL	mm	3985	3985	3985	3985	3985	3985
Weight without front attachment with standard equipment ²	kg	14150	14150	13550	13300	13300	12900

¹ Detailed information about the values can be found in the corresponding operator's manual

² V-MAX 24, front attachment drive standard, crop flow standard, discharge chute extension M, without rear ballast, diesel and urea tanks empty

JAGUAR 900	990	980	970	960	950	940
Engine						
Manufacturer	MAN	MAN	MAN	Mercedes-Benz	Mercedes-Benz	Mercedes-Benz
Type	D2862	D2862	D4276	OM 473 LA	OM 473 LA	OM 460 LA
Cylinders	V12	V12	S6	S6	S6	S6
Displacement	l	24.24	24.24	15.90	15.60	12.82
Maximum output (ECE R 120)	kW (hp)	680 (925)	626 (850)	581 (790)	480 (653)	400 (544)
Working speed at maximum output (ECE R 120)	rpm	1800	1800	1750	1600	1600
Fuel tank (standard) + auxiliary tank (option)	l	1200 + 300	1200 + 300	1200 + 300	1200 + 300	1200 + 300
HVO ready		●	●	●	●	●
Fuel consumption measurement		○	○	○	○	○

Chassis						
Ground drive: 2-speed transmission, automatic OVERDRIVE (hydrostatic)		●	●	●	●	●
Tyre pressure control system for drive axle and steering axle		○	○	○	○	○
Differential lock		○	○	○	○	○
Standard steering axle		○	○	○	○	○
Steering axle, 3 x adjustment, 2510 / 2970 / 3130 mm		○	○	○	○	○
Steering drive axle, POWER TRAC, hydraulic		○	○	○	○	○
Water / silage additive tank, content 375 l		●	●	●	●	●
Silage concentrate system, ACTISILER 37, capacity 37 l		○	○	○	○	○

Front attachments						
ORBIS 900 / 750 / 600 SD / 600 / 450, Working widths 8.93 / 7.45 / 6.04 / 6.01 / 4.48 m		○ ORBIS 900 / 750 / 600	○ ORBIS 900/750/600	○ ORBIS 900/750/600	○ ORBIS 900/750/600	○ ORBIS 900/750/600
PICK UP 380 / 300, Working width 3.60 / 2.62 m		○	○	○	○	○
DIRECT DISC 600 P / 500 P, Working width 5.96 / 5.13 m		○	○	○	○	○
DIRECT DISC 600 / 500, Working width 5.96 / 5.13 m		○	○	○	○	○

Front attachment drive						
Front attachment drive, mechanical		●	●	●	●	●
Front attachment drive, variable speed		○	○	○	○	○
Front attachment drive - split-power for DIRECT DISC and maize picker		○	○	○	○	○
Front attachment drive variable and PICK UP reel variable		○	○	○	○	○

Feeder unit						
Width 730 mm		●	●	●	●	●
Feed and precompression rollers, no.: 4		●	●	●	●	●
Hydraulic precompression		●	●	●	●	●
COMFORT CUT length of cut adjustment, infinitely variable		●	●	●	●	●

Chopping cylinder						
Width 750 mm		●	●	●	●	●
Diameter 630 mm		●	●	●	●	●

● Standard ○ Option □ Available – Not available

JAGUAR 900	990	980	970	960	950	940
V-MAX knife configuration						
V20 (2 × 10), length of cut 5-26.5 mm		○	○	○	○	○
V24 (2 × 12), length of cut 4-22 mm		○	○	○	○	○
V28 (2 × 14), length of cut 4-18.5 mm		○	○	○	○	○
V36 (2 × 18), length of cut 3.5-14.5 mm		○	○	○	○	○
V42 (2 × 21), length of cut 3.5-12.5 mm		○	○	○	–	–
Automatic knife sharpening from cab		●	●	●	●	●
Automatic adjustment of shear bar from cab		●	●	●	●	●

MULTI CROP CRACKER						
MCC CLASSIC M, ø 196 mm		–	–	–	○	●
MCC CLASSIC L, ø 250 mm		●	●	●	○	–
MCC MAX, ø 265 mm		○	○	○	○	–
MCC SHREDLAGE® M, ø 196 mm		–	–	–	○	○
MCC SHREDLAGE® L, ø 250 mm		○	○	○	○	–

Crop accelerator						
Width 680 mm		●	●	●	●	●
Diameter 540 mm		●	●	●	●	●
Gap setting 2-10 mm		○	○	○	○	○

Discharge chute						
Collision protection		●	●	●	●	●
210° swivel angle		●	●	●	●	●
Swivel angle with OPTI FILL / AUTO FILL 225°		○	○	○	○	○

Operator assistance systems						
AUTO PILOT central sensors (maize)		○	○	○	○	○
CAM PILOT swath tracking guidance (grass)		○	○	○	○	○
GPS PILOT		○	○	○	○	○
Dynamic steering		○	○	○	○	○
STOP ROCK		○	○	○	○	○
QUANTIMETER		○	○	○	○	○
Automatic length of cut control		○	○	○	○	○
OPTI FILL, optimised chute control		○	○	○	○	○
AUTO FILL, automatic trailer filling		○	○	○	○	○
NIR sensor, for measuring dry matter and constituents		○	○	○	○	○
DYNAMIC POWER		○	○	○	○	○
CEMOS AUTO PERFORMANCE		●	●	●	●	●
Machine connect licence - 5 years		●	●	●	●	●
Job management		○	○	○	○	○
Yield mapping		○	○	○	○	○

CLAAS continually develops its products to meet customer requirements. This means that all products are subject to change without notice. All descriptions and specifications in this brochure should be considered approximate and may include optional equipment that is not part of the standard specifications. This brochure is designed for worldwide use. Please refer to your nearest CLAAS dealer and their price list for local specification details. Some protective panels may have been removed for photographic purposes in order to present the function clearly. To avoid any risk of danger, never remove these protective panels yourself. In this respect, please refer to the relevant instructions in the operator's manual. All technical specifications relating to engines are based on the European emission regulation standards: Stage. Any reference to the Tier standards in this document is intended solely for information purposes and ease of understanding. It does not imply approval for regions in which emissions are regulated by Tier.

● Standard ○ Option □ Available – Not available



CLAAS KGaA mbH
Mühlenwinkel 1
33428 Harsewinkel
Deutschland
Tel. +49 5247 12-0
claas.com