



Tractors

AXION

950 940 930 920





Full output. Designed for the really big challenges – from fieldwork to transport work.
Page 8

CEMOS for tractors	4
CLAAS POWER SYSTEMS	6
Engine	8
CMATIC continuously variable transmission	10
Construction	14
Rear linkage	16
PTO	18
Hydraulics	20
Front linkage	22
Cab and comfort	24
CEBIS	26
Comfort	32
Operator assistance systems and data management	34
CEMOS operator assistance system	36
CSM headland management	38
GPS PILOT CEMIS 1200	40
ISOBUS functions	42
Data management	44
Maintenance	46
CLAAS Service & Parts	48
Features	50
Technical data	51



CEMOS for tractors. The assistance system optimises the machine and implement for significant cost savings.
Page 36



The right speed every time. Three different PTO speeds are available for the AXION 900.
Page 18

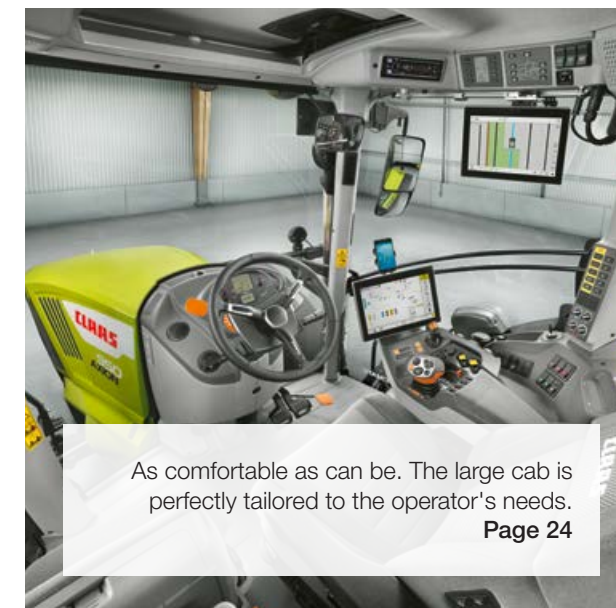

As comfortable as can be. The large cab is perfectly tailored to the operator's needs.
Page 24

More innovation: more details here.

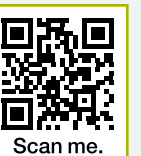

Scan me.

axion900.claas.com

CEMOS drivers are unbeatable.

What is CEMOS?

Think of CEMOS as your on-board CLAAS advisor, there to assist you with your daily work. The system suggests setting values and helps the driver continually adjust the machine to the field conditions. CEMOS takes the hassle out of settings and optimises machine performance more quickly.

The advantages of CEMOS.

- Reduces tyre wear
- Reduces soil compaction by optimising tyre pressure
- Calculates the risk of soil compaction automatically using the scientifically based Terranimo® model
- Reduces operating costs by increasing work rates
- Utilises the full potential of the machine
- Reduces implement wear (implement assistant for ploughs and DISCO disc mowers)
- Improves the carbon footprint of your farm

Tested, certified and awarded the 'DLG-approved' quality seal by independent test institute the DLG (German Agricultural Society):

- Up to 16.3% higher work rate (ha/h)
- Up to 16.8% lower fuel consumption (l/ha)
- Eight out of ten test participants managed to reduce their fuel consumption while at the same time increasing their work rate

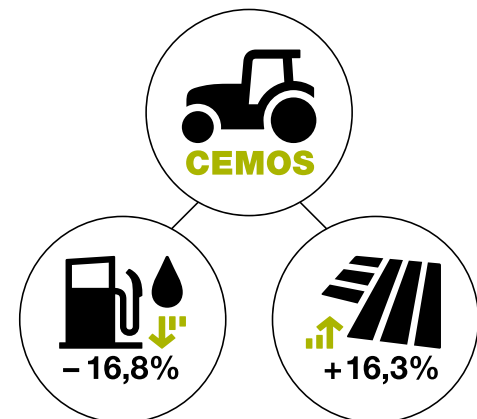

All CEMOS info.
Discover how the system can
reduce your fuel consumption
and increase your work rate.
ceмос.claas.com



Scan me.



Our drive system:
the perfect interplay between optimal components.

Your CLAAS machine is much more than the sum of its individual parts. Top performance is only possible when all parts are ideally matched and work together optimally.

In CLAAS POWER SYSTEMS (CPS), we have brought together top-quality components to create an intelligent drive system that sets new standards. Full engine output only when you need it. Drives that are suited to the way your machines are used. Fuel-saving technology which quickly pays off.

Higher output – lower fuel consumption.

Pure power.

The AXION 900 – designed for the really big challenges, with full engine output across the entire spectrum from fieldwork to transport work. Thanks to CMATIC powertrain management, the AXION 900 employs a modern low-speed concept: higher output at lower engine speeds and automatic engine speed adjustment reduce operating costs. Under the one-piece bonnet lies a 6-cylinder FPT Cursor 9 engine with 8.7 l capacity. It is equipped with the latest common rail 4-valve technology, intercooling and a turbocharger.

AXION	Torque (Nm)	Maximum output (hp) ECE R 120
950	1760	423
940	1709	398
930	1630	363
920	1550	329

Variable turbo.

Optimised combustion means low fuel consumption and maximum performance. The turbocharger delivers optimum charge-air pressure at any engine speed. It adjusts to load and engine speed, making 70% of maximum torque available even when idling.

Low-speed concept

Further benefits include greater convenience and longer working hours on one tank of fuel:

- Constant output range of 1,700 to 1,800 rpm
- Constant torque range of 1,300 to 1,500 rpm
- 95% of max. output available at the 1000 ECO rear PTO
- Reduced engine speed for transport work at 40 or 50 km/h (1,400 or 1,600 rpm)
- Two idling speeds (650 and 800 rpm) with automatic adjustment reduce stationary fuel consumption by up to 2 l/h

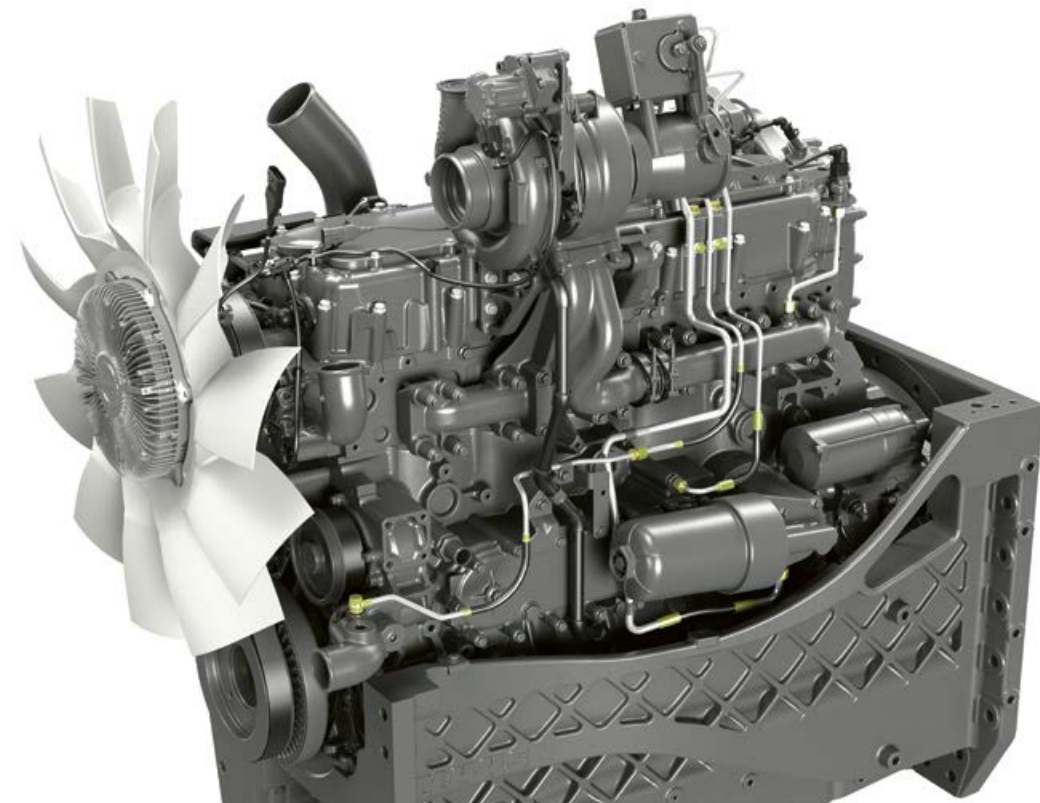

Visctronic – efficient fan control.

With Visctronic electronic fan control, the fan speed can be precisely aligned with engine temperature and load, ensuring that the engine always runs at the optimum temperature.

The reduced fan speed lowers the noise level and saves valuable fuel with no unnecessary impact on output, which can then be converted into tractive power.

CLAAS CMATIC.

The future is infinitely variable.



Superior transmission control.

Powerful acceleration, smooth deceleration and a fast response to changes in load: CMATIC powertrain management shows its capabilities in all conditions and for every task. Stay relaxed and focused throughout the working day – CMATIC does the rest for you. In the AXION 900 series, the ZF Terramatic transmission provides efficient conversion of engine power. In this split-power, continuously variable transmission, the four mechanical ranges are automatically selected by multi-disc clutches.

Precise work.

CMATIC allows drivers to create their own profiles according to the job in hand. Intelligent CMATIC transmission technology enables you to use the full power of your AXION economically and productively – with maximum operator comfort.

With the CMATIC transmission, three speed ranges can be pre-selected in both directions of travel. The active range is displayed in CEBIS and can be changed while the tractor is in motion using two buttons. The lower the maximum preset value for the range, the more accurately the forward speed can be controlled.

Efficient and reliable.

With engine speeds of 1,600 rpm at a top speed of 50 km/h and 1,400 rpm at 40 km/h, the AXION 900 also demonstrates its capabilities in transport operations. If the accelerator is not depressed, the transmission is in powered zero mode and maintains its position without creeping or rolling. This means that the tractor can start up safely and easily at steep field entrances or road junctions, even with a full load. The high mechanical component in the power transmission provides outstanding efficiency and low fuel consumption in every speed range.

Stopping power.

The CMATIC transmission offers different ways of adapting braking to the job in hand.

Reduced brake wear.

When the accelerator pedal is released and the multifunction control lever is pulled back, the transmission ratio is reduced, causing the engine speed to increase. The optional engine retarder also comes into play. It engages automatically when needed and increases the engine braking effect by up to 2.5 times.

Safe every time.

When the trailer is braked with the service brake, you can accelerate at the same time using the accelerator pedal or by pressing the multifunction control lever. This maintains the distance between the tractor and trailer on steep hills and increases safety. These functions can be used whether the tractor is stationary or moving.

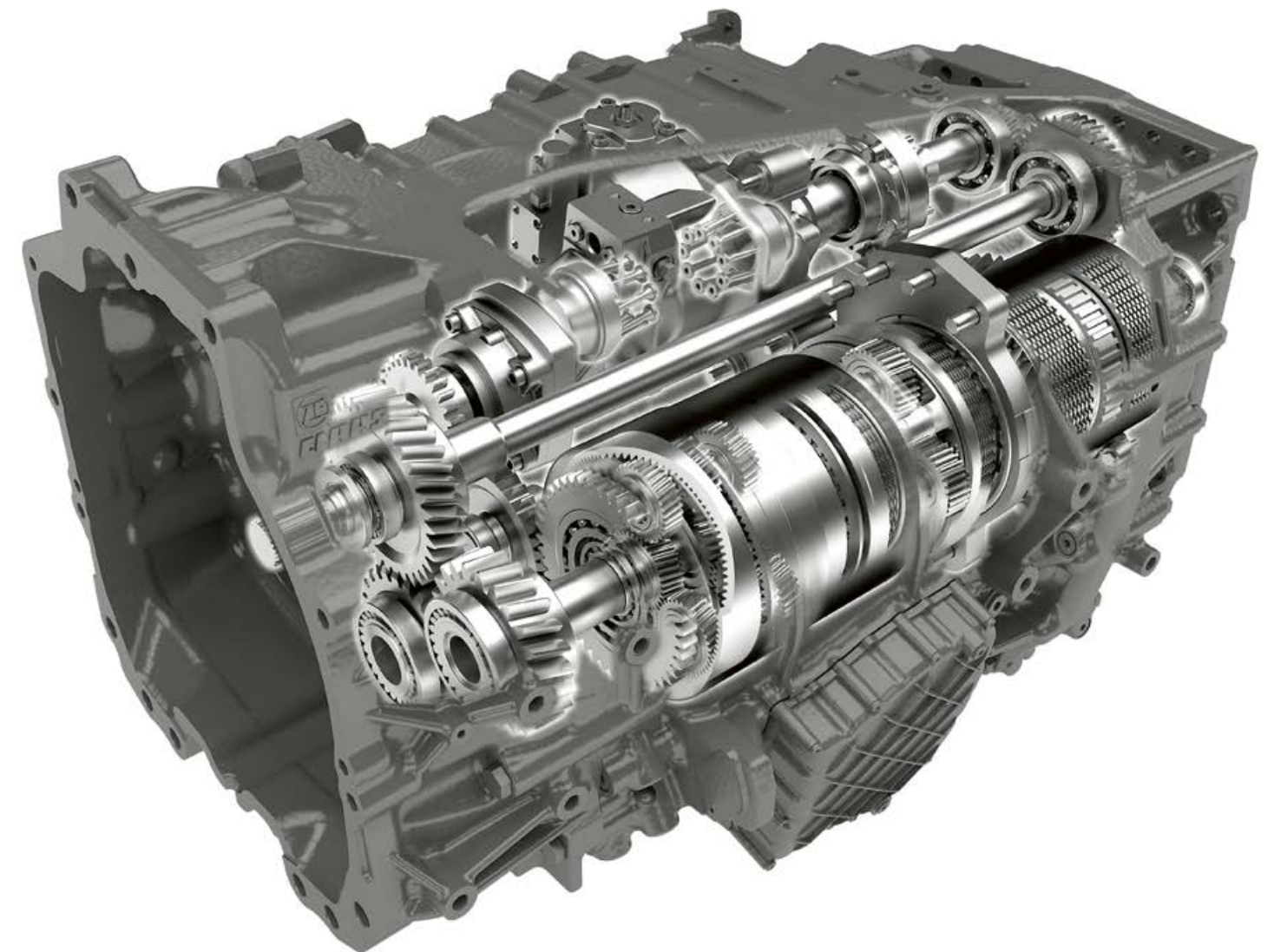

CMATIC. Optimised settings.



Engine droop setting for 'Eco' and 'Power', and for the engine speed memory.

Engine droop at the push of a button.

The engine droop value can be used for quick and easy adjustment of the maximum engine speed under full load.

The CEMOS operator assistance system helps the driver adjust the machine to the field conditions during tillage work to prioritise maximum efficiency or performance.

Two engine droop values can be saved and retrieved via the quick-access facility using the F buttons. These 'Eco' and 'Power' values enable the droop to be rapidly adjusted to the task in hand, e.g. when moving from road to field.

When a constant engine speed is activated, i.e. during PTO work, you can specify a different droop setting, typically one that matches the engine speed to the required PTO shaft speed.



Simple, straightforward operation.

The CMATIC transmission has three operating modes: accelerator pedal, drivestick and manual mode.

In the first two modes, forward speed can be controlled by the accelerator pedal or drivestick. The engine speed and transmission ratio are adjusted automatically – for optimum efficiency and optimised fuel consumption. In manual mode, the driver chooses the engine speed and transmission ratio. Automatic engine and transmission control is disabled.

Accelerator pedal or drivestick.

You can switch between accelerator pedal and drivestick mode while the tractor is moving by pressing a button on the armrest. The active mode is displayed in CEBIS.



The drive mode is displayed in CEBIS. On the move, you can switch between drivestick and accelerator pedal mode at the press of a button.

Stable and manoeuvrable.
Immense tractive power.

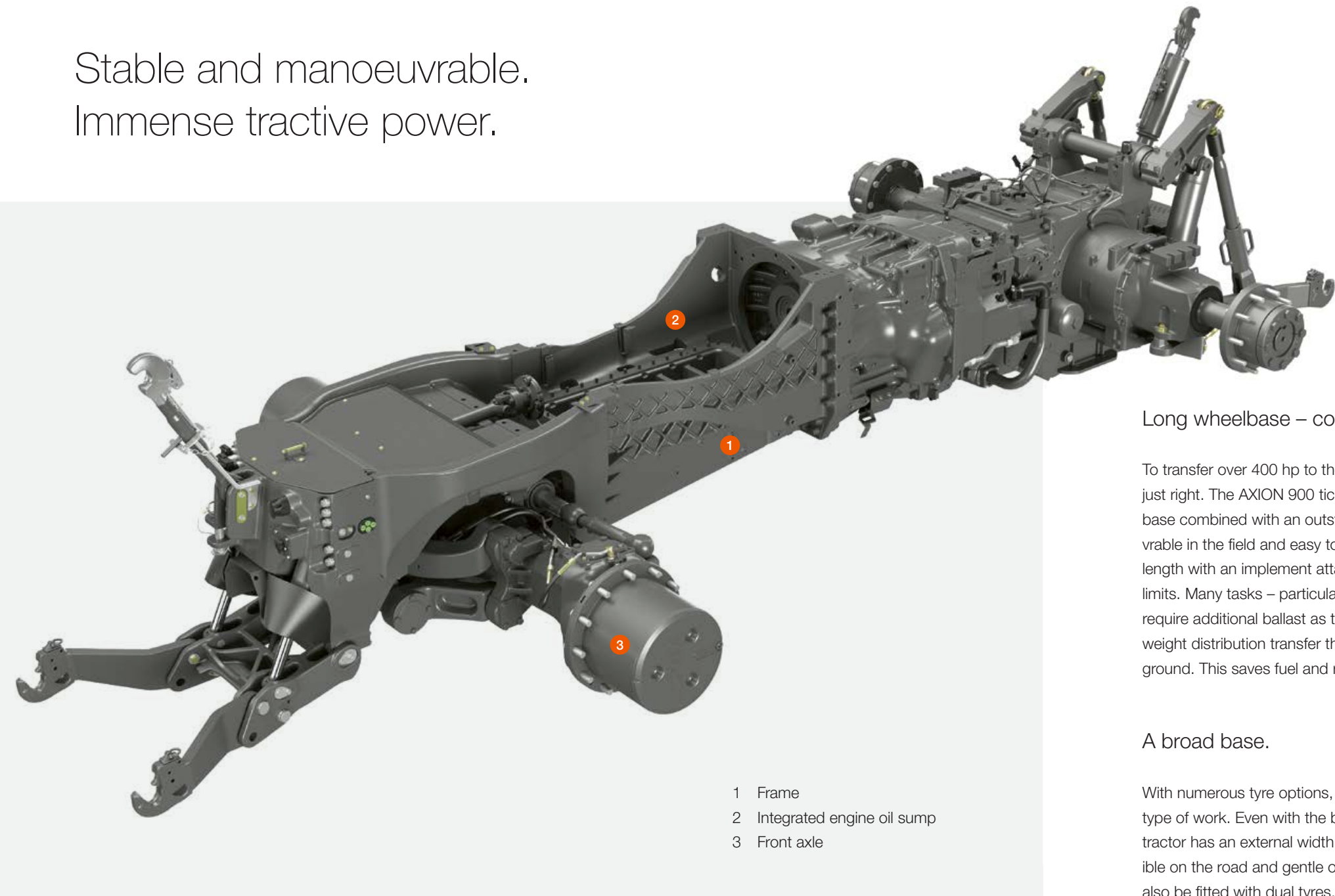

- 1 Frame
- 2 Integrated engine oil sump
- 3 Front axle

Long wheelbase – compact design.

To transfer over 400 hp to the ground, the design has to be just right. The AXION 900 ticks all the boxes. A 3.15 m wheelbase combined with an outstanding design makes it manoeuvrable in the field and easy to drive on the road. Its overall length with an implement attached remains within the legal limits. Many tasks – particularly transport operations – do not require additional ballast as the long wheelbase and optimum weight distribution transfer the tractor's tractive force to the ground. This saves fuel and reduces tyre wear on the road.



Right overall length:

- Good manoeuvrability
- Short trailer combination on the road
- Clear, wide overview
- Good guidance of front-mounted implements

A broad base.

With numerous tyre options, the AXION 900 is capable of any type of work. Even with the biggest tyres (900/60 R 42), the tractor has an external width of less than 3.0 m, making it flexible on the road and gentle on the field. The AXION 900 can also be fitted with dual tyres.¹



Good power to weight ratio:

- Optimises fuel consumption
- Low ground pressure during tillage
- Dynamic road transport
- 50:50 weight distribution front / rear

Real stability.
The true sign of a 400 hp tractor.

Drawing on experience gained in developing tractors delivering 500 hp or more, CLAAS has created a completely new solution for the AXION 900 – for endurance work under extremely challenging conditions.

The engine is housed in a strong frame section with an integrated engine oil sump which absorbs all the forces associated with the front linkage and front axle support.

In practice, this means:

- Maximum stability even when using heavy front-mounted implements
- Excellent steering lock angle for maximum manoeuvrability
- Optimum access to the entire engine compartment and all maintenance points
- All services securely routed within the frame section

Tyre pressure adjustment system.

Reducing the ground pressure by adjusting the tyre pressure has economic benefits for farmers and contractors. It increases the tractor's tractive power, reduces fuel consumption and extends the life of the tyres – increasing efficiency on the field, and for the machine as a whole.

¹ Dual tyres are not available in all countries. Please refer to your dealer's price list.

Lifts any implement.
The rear linkage.



External controls for the rear linkage, PTO and one freely selectable spool valve



Several positions are available in the drawbar versions. The extended position increases manoeuvrability.



Optional hydraulic side stabilisers ensure greater safety and ease the work load

A hitch to suit every need.

The tow hitch support on the AXION 900 is ISO 500-compliant. This means that hitches on other machines which conform to the same standard can be used. A wide range of factory-fitted hitch options are available:

- Pick-up hitch
- In the drawbar frame:
 - automatic clevis, 38 mm
 - K80 hitch ball
 - CUNA hitch system
- As a drawbar:
 - with Cat. III or Cat. IV
 - with Piton-Fix coupling
 - with K80 hitch ball and positive steering

A number of holes are provided in the drawbar versions so that the distance between the PTO stub and hitch point can be adjusted. This gives greater flexibility and improves manoeuvrability.

Direct adjustment on the B pillar.

- Manual lift and lower for machine attachment
- Vibration damping on / off
- Lock rear linkage
- Lifting height limiter and lowering speed
- Position / draught control and wheel slip control

The convex rear window and swivelling seat provide an excellent view of the implement and unimpeded operation of the rear linkage controls. The conveniently located controls enable the driver to optimise the rear linkage settings while work is in progress.

The rear linkage.

With a maximum lifting capacity of 11 t, these tractors can carry the heaviest of implements. The configuration of the rear hydraulic system can be tailored to individual requirements:

- Cat. III or Cat. IV lower links
- Mechanical or hydraulic top link, Cat. III or Cat. IV
- Manual or automatic stabilisers for both lower links
- Wheel slip control via radar speed
- External controls on both mudguards for the rear linkage, PTO and one electronic spool valve
- Practical ball holder at the rear



Powerful and economical
at the push of a button.



The right speed every time.

Three different PTO options are available for the AXION 900:

- 1000 rpm
- 540 ECO / 1000 rpm
- 1000 / 1000 ECO rpm

The PTO speed is easily pre-selected at the touch of a button. Another button activates the PTO.

Automatic PTO engagement / disengagement is activated at a specified linkage height which is continuously adjustable. To save the height, you just move the rear linkage to the required position and give a long press on the automatic PTO button.

The integral freewheel on the rear PTO makes implement hitching simple.

Standing start.

The AXION 900 transfers its full power from a standing start and even at low forward speeds. Despite the reduced engine speed, in ECO mode up to 95% of maximum engine power (e.g. 351 hp and 1,583 Nm in the AXION 930) can be transmitted to the PTO shaft, enabling even heavy implements to be operated at a reduced engine speed.

Rotational speeds:

- 1000 ECO rpm at 1,600 engine rpm
- 540 ECO rpm at 1,450 engine rpm

PTO with the right engine speed.

A press of a button on the rear mudguard is all it takes to switch on the rear PTO and then activate the engine speed memory. Just set the right engine speed for the attached implements in CEBIS in advance. This is recommended for all operations when you routinely use the external PTO switch. It saves time and makes your job easier and safer.

Powerful hydraulics. Simple connections.

Pressure-free connections and no mess.

All the hydraulic couplings at the rear of AXION tractors have release levers, so they can be connected and disconnected even under pressure.

The colour-coding on the inlet and outlet sides make it easier to attach implements correctly. Oil leakage lines collect the oil from the couplings when attaching and removing connectors.



When a front linkage is installed, up to two double-acting spool valves and one free-flow return line are available at the front. Ideal for a front-mounted seed hopper or dozer blade.

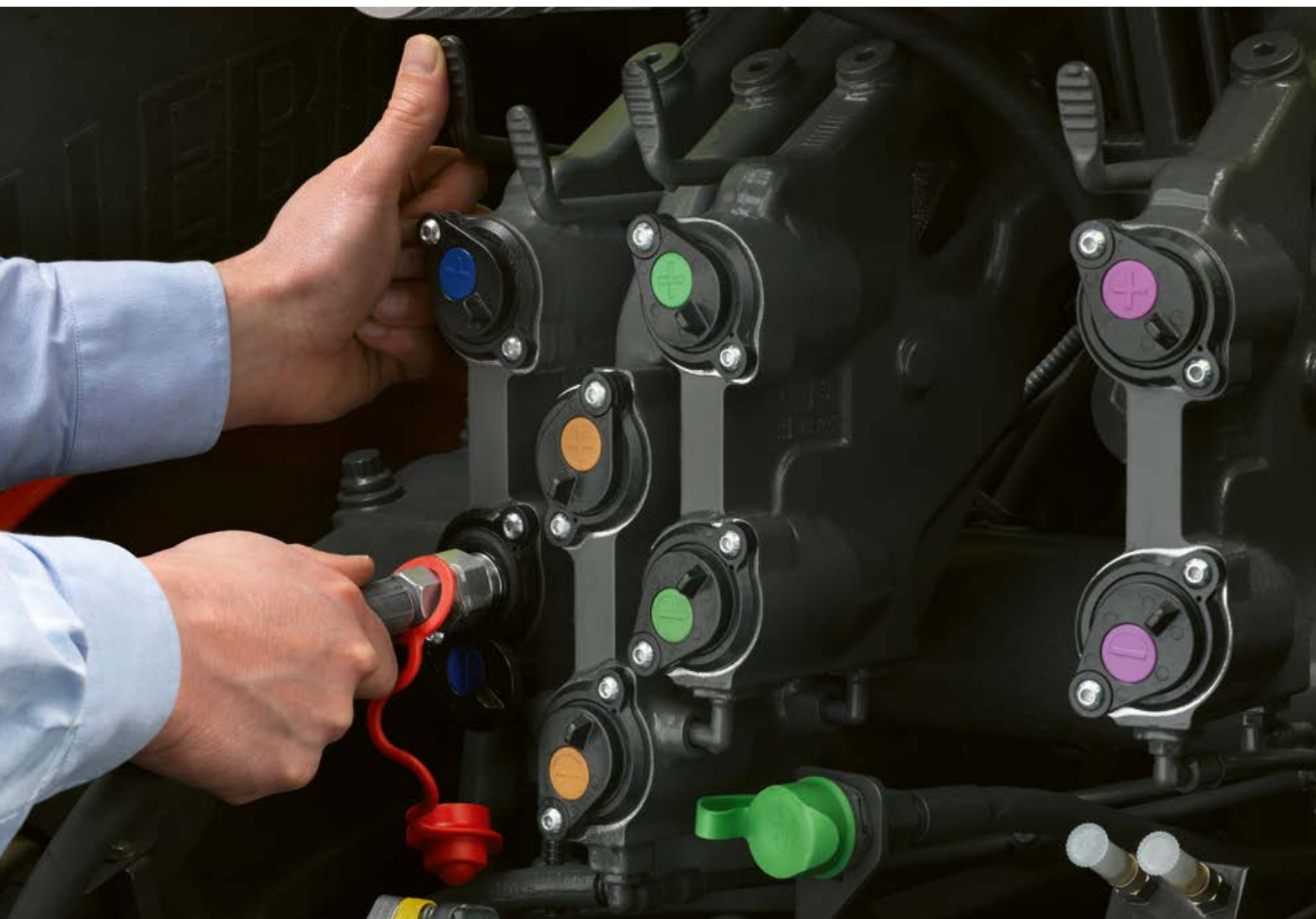
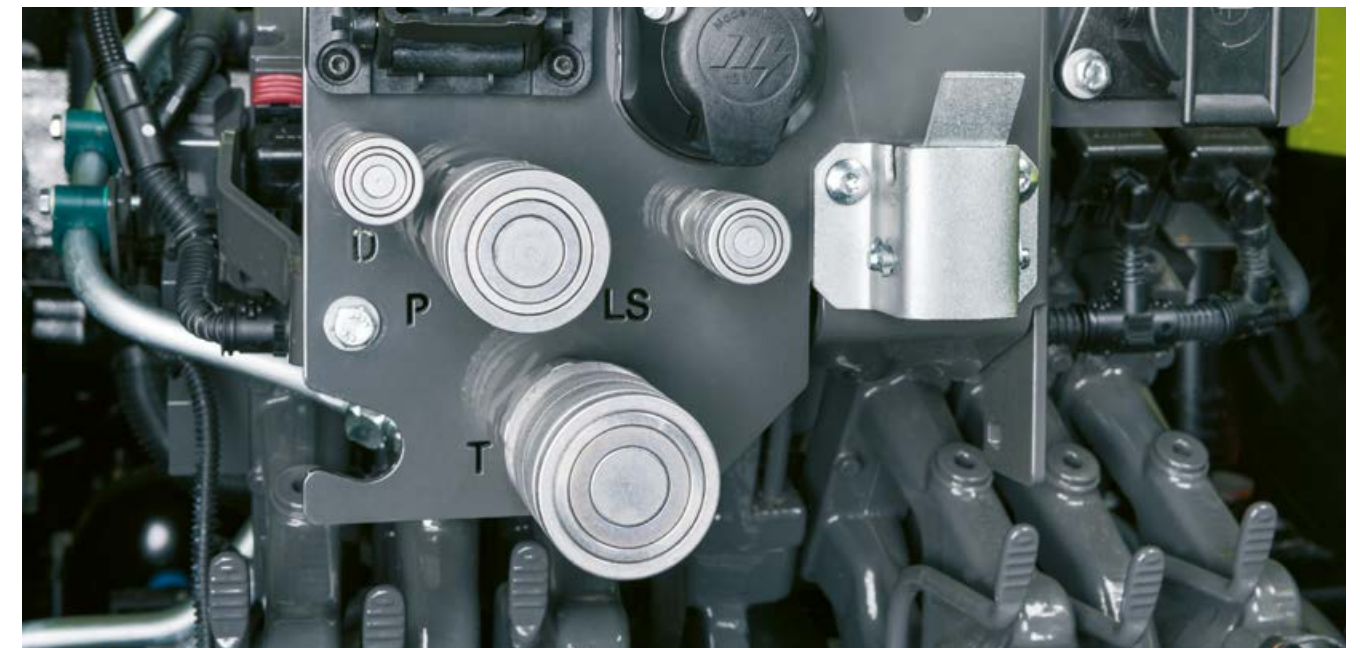

Hydraulics that get the job done.

- Load-sensing hydraulic system for all AXION 900 models with 150 or 220 l/min output
- Controls for up to eight electronic spool valves on the armrest – four of which can be operated by ELECTROPILOT. Thanks to free assignment and prioritisation of the spool valves, every driver can adapt CEBIS operation to suite their personal preferences and the task in hand.
- Spool valve operation can be assigned to the F buttons on the CMOTION, multifunction armrest or ELECTROPILOT to lighten the workload during combined operating processes.

Equipment	
Max. number of electronic spool valves, front	2
Max. number of electronic spool valves, rear	6
Operated with a rocker switch in the armrest	4
Operated with ELECTROPILOT	4
Spool valve prioritisation	●
Free spool valve assignment	●

● standard

Power Beyond.

Power Beyond connections are provided at the rear for implements with their own load-sensing control units.

In addition to the standard pressure, return and signal lines, the tractor also has a free-flow return line. The AXION is therefore prepared for operation of hydraulic motors with a separate return line, even when the Power Beyond connections are in use.

Benefits:

- Hydraulic oil is supplied to the attached implement as required
- Large-diameter lines and non-pressurised return flow reduce power losses

More versatility.
More applications.



Front linkage with position control.

External control of the front linkage and one spool valve relieve the burden of day-to-day work. The optional load control enables precise work with front-mounted implements.

The operating position is adjusted with a rotary knob on the armrest, and you can limit the lifting height and set the lifting and lowering speed in the CEBIS. The front linkage can be used in single- or double-acting mode.

Front linkage.

All AXION 900 models can be factory-fitted with a reinforced 6.5 t front linkage. The AXION has a fully integrated front linkage designed by CLAAS. The front axle carrier and the special structural component for the engine are designed to absorb any forces generated, meaning no additional supports or rails are required.

A 1,000 rpm front PTO is also available. It is effortlessly engaged by pressing a button in the cab.

Compact construction:

- Short distance between front axle and coupling points
- Good implement handling and short overall length

Always connected.

Optional hydraulic and electronic interfaces for many applications are incorporated into the front linkage:

- Up to two double-acting spool valves
- Free-flow return line
- 7-pin socket
- ISOBUS connection or 25 A socket

Greater comfort means higher productivity.

Spacious and quiet, with large windows and full suspension: the cabs on AXION tractors guarantee maximum comfort throughout long working days.

- CEBIS terminal operated via touchscreen or rotary pushbutton
- Innovative CMOTION multifunction control lever with natural ventilation
- ISOBUS UT control interface integrated into CEBIS
- GPS PILOT CEMIS 1200. Automatic steering system and precision farming



CEBIS version. Simply everything.

An armrest that sets new standards.

All the main controls are integrated into the right-hand armrest:

- 1 CMOTION multifunction control lever
- 2 Control panel for drive mode, range changing and two engine speed memories with fine adjustment
- 3 CEBIS terminal with 12" touchscreen
- 4 ELECTROPILOT with two double-acting spool valves and two F buttons
- 5 CEBIS control panel
- 6 Working depth adjustment for front and rear linkage
- 7 Activate front and rear PTO
- 8 Hand throttle
- 9 Transmission in neutral, activate front linkage
- 10 Electronic spool valves
- 11 Four-wheel drive, differential lock, automatic PTO engagement / disengagement, front axle suspension
- 12 Main switch: battery, electronic spool valves, CSM, steering system



The height and position of the armrest can easily be adjusted to the driver's requirements.

Functions that are used less frequently, such as PTO speed preselection and the main switches, are located to the right of the driver's seat.

When the driver's seat is rotated, the rear linkage control system can be operated comfortably with an excellent view of the attached implement. This allows settings to be finely adjusted while work is in progress. Two additional buttons enable the rear linkage to be raised and lowered manually for easier implement attachment.

Uncluttered layout.

In all versions, many functions can be controlled directly using the rotary switches and buttons on the B-pillar.

- 13 PTO speed selection
- 14 Rear linkage settings
- 15 Rear linkage status display
- 16 Controls for electronic rear linkage control system

CMOTION multifunction control lever. Everything in hand.



CMOTION multifunction control lever.

The CMOTION is a CLAAS concept which makes using the main functions of the AXION easier and more efficient. Functions are controlled using your thumb and forefingers, allowing your arm to rest comfortably on the padded armrest and preventing fatigue.

CMATIC operation.

Effortless drive control is ensured by the CMOTION. A slight push activates the powershift speed. With the CMATIC, the forward speed can be adjusted precisely and continuously using the CMOTION.



Progressive operation with CMATIC continuously variable transmission technology

At the push of a button.

The free assignment option for the ten function buttons on the CMOTION means that there is no longer any need to reposition your hands while you work. All implement-specific ISOBUS functions are easily controlled using the CMOTION:

- ISOBUS functions
- Event counter on / off
- Spool valves

Rear linkage functions on the CMOTION:

- Lower to preset working position
- Raise to preset lift height position
- Manual activation: lift and lower at two speeds (slow / fast)
- Quick implement entry

- 1 Start up / change direction
- 2 Rear linkage
- 3 Activate GPS PILOT
- 4 CSM headland management
- 5 F7 / F8 / F9 / F10 function buttons
- 6 Activate cruise control
- 7 F1 / F2 function buttons
- 8 F5 / F6 function buttons

CEBIS terminal. Everything under control.



Clear layout and fast operation.

The 12" CEBIS screen uses self-explanatory symbols and colour coding to give a clear picture of the settings and operating statuses. Thanks to the CEBIS menu structure and touchscreen, all settings can be entered in just a few steps. A particularly attractive feature is the DIRECT ACCESS function with the machine silhouette. Just tap the relevant area to get straight to the right dialogue window.

An eye-catching 12" screen.

- 1 Machine silhouette for DIRECT ACCESS and status display
- 2 Spool valve status
- 3 Vehicle information
- 4 Top sub-field: performance monitor
- 5 Middle sub-field: function button assignment
- 6 Bottom sub-field: transmission information
- 7 Menu
- 8 DIRECT ACCESS via CEBIS touch button or button on the armrest

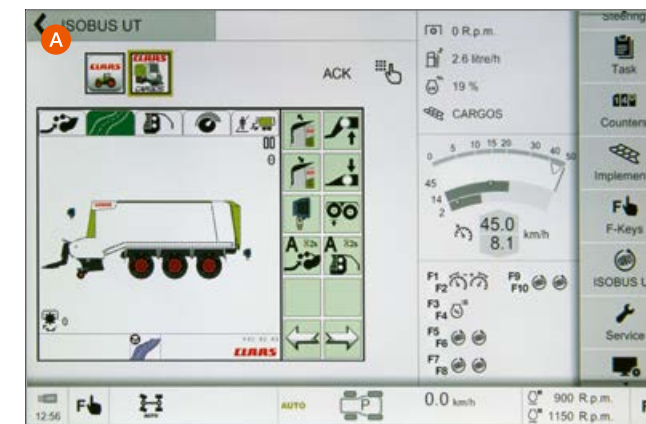

Integrated ISOBUS implement control (A).

- In CEBIS intuitively switch between ISOBUS implements, road travel and field work screen layouts
- Clear view of ISOBUS implements in main field
- Simply connect ISOBUS cable at the front or rear and off you go
- Assign up to ten ISOBUS functions to CMOTION function buttons for direct operation

Camera image display function (B).

- 1 Display up to two camera images in the sub-field
- 2 Toggle between machine silhouette, Camera 1 and Camera 2 in the main field

CEBIS – simply better:

- Fast and intuitive navigation using the CEBIS touchscreen
- Rapid access to the sub-menus with the DIRECT ACCESS touch button on CEBIS or button on the armrest
- Tap the machine silhouette, main field or sub-field
- Navigate using the rotary switch and ESC button on the armrest – ideal when driving on rough terrain
- Two different screen layouts available (road travel and field work)
- ISOBUS function
- Specify the user type: limit the scope of CEBIS settings to suit driver experience
- Freely assign the three sub-fields, e.g. for transmission, front and rear linkage, function buttons, headland sequences, camera or performance monitor

As well as screen-based operation with CEBIS, there is a set of buttons in the armrest. Full CEBIS operation is available using the rotary switch and ESC button if uneven ground reduces the accuracy of fingertip operation. The DIRECT ACCESS button takes you straight to the settings for the last used tractor function.



- 1 Menu navigation
- 2 Select
- 3 ESC button
- 4 DIRECT ACCESS button

Protects both driver and machine. The suspension.



4-way suspension.

Four suspension points mean that the cab is fully isolated from the chassis, preventing impacts and vibration from reaching the driver. Longitudinal and lateral struts join the suspension points and keep the cab stable when turning corners or braking. The entire suspension system is completely maintenance-free.



Sit better. Work better.

The wide range of seats includes a ventilated premium seat.

- Active seat ventilation makes the seat feel good whatever the weather
- Suspension automatically adjusts to the driver's weight



PROACTIV front axle suspension.

The suspension adjusts to tractor loading and automatically remains in the central position. Changes in load due to braking and turning manoeuvres are also compensated. Parallelogram axle suspension and 90 mm spring travel guarantee a smooth ride.



Vibration damping.

Heavy implements mounted on the front put a strain on the tractor as well as the driver. The front and rear linkage are both equipped with vibration damping to compensate for peak loads during transport operations and when the attached implement is raised at the headland.

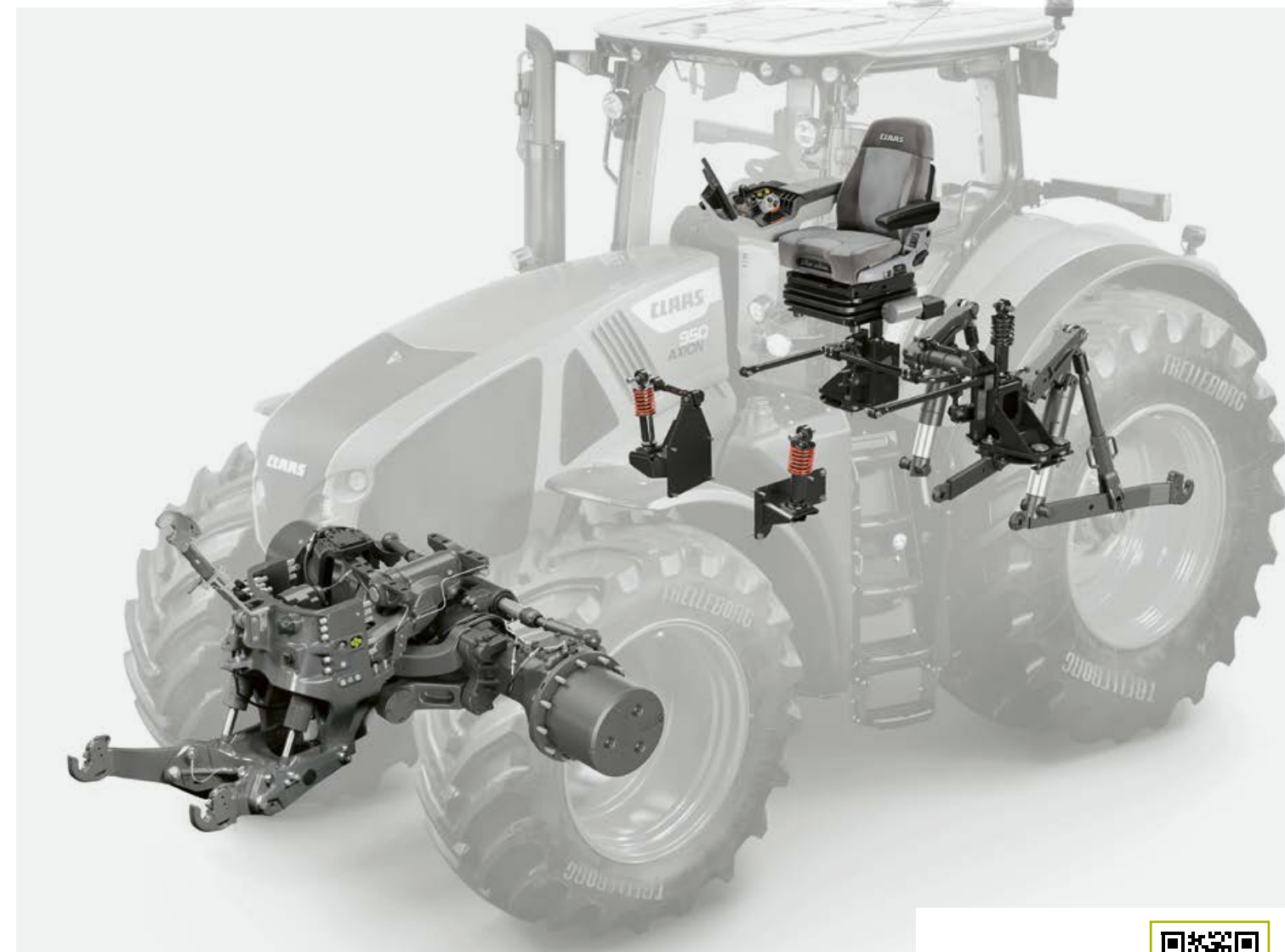

Enhanced comfort.

The AXION 900 is equipped with suspension points for the cab, front axle and linkage, which are designed to minimise vibrations. Ride comfort is further enhanced by the rear wheels with adapted air pressure.

Experience the full-suspension cab in action



Scan me.

Operator assistance systems.

There is no substitute for your experience. It's what allows you to respond quickly and appropriately to the challenges you face in your daily work. When you're dealing with difficult terrain or changing soil conditions, you have to make decisions very quickly to get the job done to the right standard. That's why it's good to be able to count on a tractor with CEMOS to reduce your workload.

Data management.

Data has long since become an indispensable resource. To profit from its full potential, you should take just as good care of your data as you do your machinery fleet. And that includes making sure all systems, machines and processes are meaningfully connected and the data generated is sent to the appropriate place for analysis.





All CEMOS info.
ceмос.claas.com

Scan me.



CEMOS teaches itself and trains the user.

The CEMOS self-learning operator assistance system is the only one of its kind on the market to optimise the performance of both the tractor and attached implements such as ploughs and cultivators. So it helps the driver set the correct ballast and tyre pressure. CEMOS uses a dialogue-based interface to make recommendations for all important settings, e.g. for the engine, transmission and implement. This helps to ensure optimum traction and soil protection at all times. With CEMOS you can increase your work rate, improve the quality of your work and reduce your fuel consumption by 16.8%.



Phase 1. Preparation in the farmyard.

CEMOS recommends the required ballasting and optimum tyre pressure to suit the selected implement and task before the driver has left the farmyard. The dynamic learning system gathers more measurements while work is under way, and adapts its recommendations accordingly next time around.

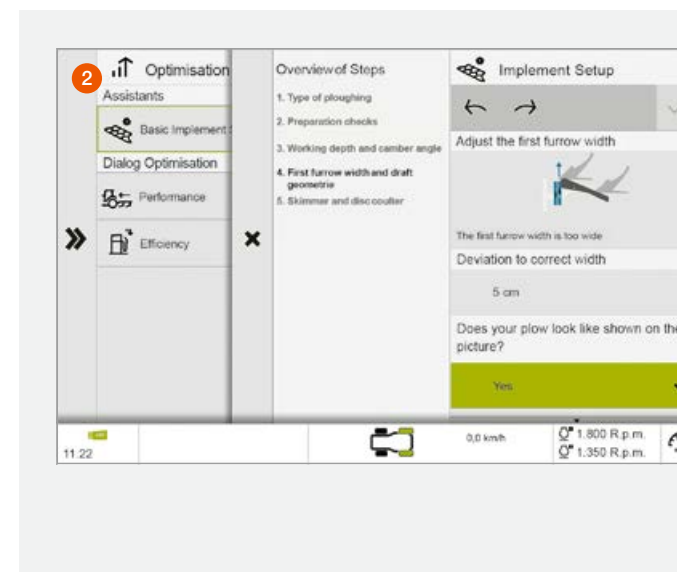

Phase 2. Basic setting in the field.

The integrated CEMOS knowledge database provides step-by-step instructions on basic settings for implements, with illustrations. Assist systems are now available for all ploughs. Further implements will follow in the near future. These provide valuable assistance for drivers working with new or unfamiliar implements.

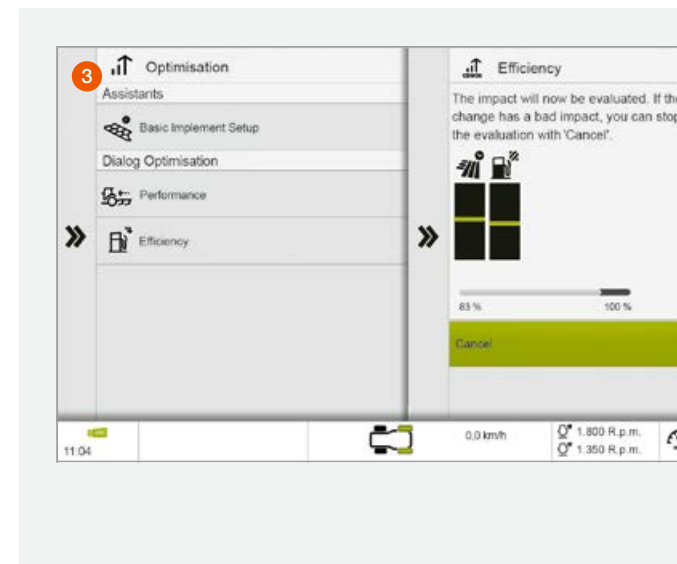

Phase 3. Optimisation while work is under way.

The driver opens the optimisation dialogue in the field. CEMOS checks all the basic settings, and offers suggestions for improving "performance" and "efficiency", which the driver can accept or reject. After each change of setting, CEMOS recalculates and shows whether the work rate and diesel consumption have improved, and by how much.

Precision at the headland with CSM.



CLAAS SEQUENCE MANAGEMENT.

CSM headland management takes the load off you whenever you need to manoeuvre at the headland. You can run any of the previously recorded functions simply by pressing a button.

	With CEBIS
Number of storable sequences	Four per implement, up to 20 implements
Sequence activation	CMOTION and F buttons
Sequence display	On CEBIS display
Recording mode	Time- or distance-related
Edit function	Subsequent sequence optimisation in CEBIS

The following functions can be combined in any order:

- Spool valves with time and flow control
- Four-wheel drive, differential lock and front axle suspension
- Front and rear linkage
- Cruise control
- Front and rear PTO
- Engine speed memory



Easy to record and run.

Sequences can be recorded on a distance- or time-related basis. In recording mode, clear symbols guide the driver step-by-step through the process of creating the sequence on the CEBIS colour display. A sequence that is running can be paused and restarted simply by pressing a button.

Non-stop optimisation with CEBIS.

Recorded sequences can be changed and optimised in CEBIS at a later date. Steps can be added and deleted or changed and adapted in minute detail, allowing times, distances and flow volumes to be tailored to current conditions. Once a sequence has been recorded, it can be refined down to the last detail in just a few steps.

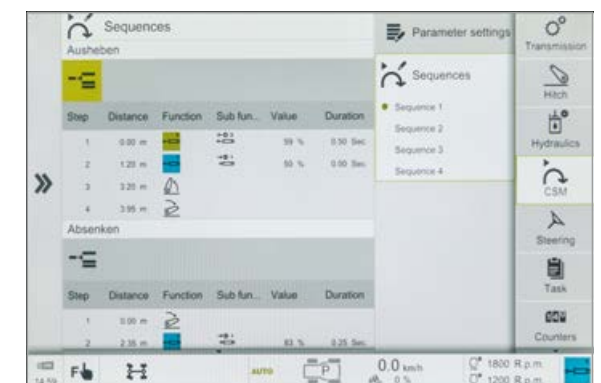

GPS PILOT CEMIS 1200.

Precision farming made easy.

Precise, future-proof, simple.

Improve the profitability of your farm and simplify day-to-day operations – step into the future with the GPS PILOT CEMIS 1200.

With the GPS PILOT automatic steering system, your machine will seem like it's running on rails: always on the right track, using the full working width with no overlapping.

The CEMIS 1200 fits seamlessly into the cab: with the same intuitive control logic as CEBIS, operators will quickly find their way around.

You can use the system on all CLAAS machines set up for GPS PILOT CEMIS 1200. The terminal and receiver can be transferred from one machine to another in next to no time, giving you complete flexibility and saving money.

Thanks to ISOBUS and standard data exchange formats, the CEMIS 1200 is the way forward for more precision in farming.

Reference track planning.

Plan your reference tracks with ease – record reference tracks spontaneously or use reference track management on the CEMIS 1200 to plan your tracks based on field boundaries. Pre-planned reference tracks can also be transferred to the terminal. CEMIS 1200 provides various different drive modes which enable you to maximise the efficiency of your fieldwork.

In addition, tramline management prompts you to create a tramline in the right position. Tramlines are highlighted in colour on the screen, giving you a perfect overview of your work. You can also activate an acoustic signal.

Benefits:

- Intuitive user interface for outstanding ease of use day and night
- Quick access to all important functions
- Freely configurable working areas for custom control
- The fast and easy way to start fieldwork

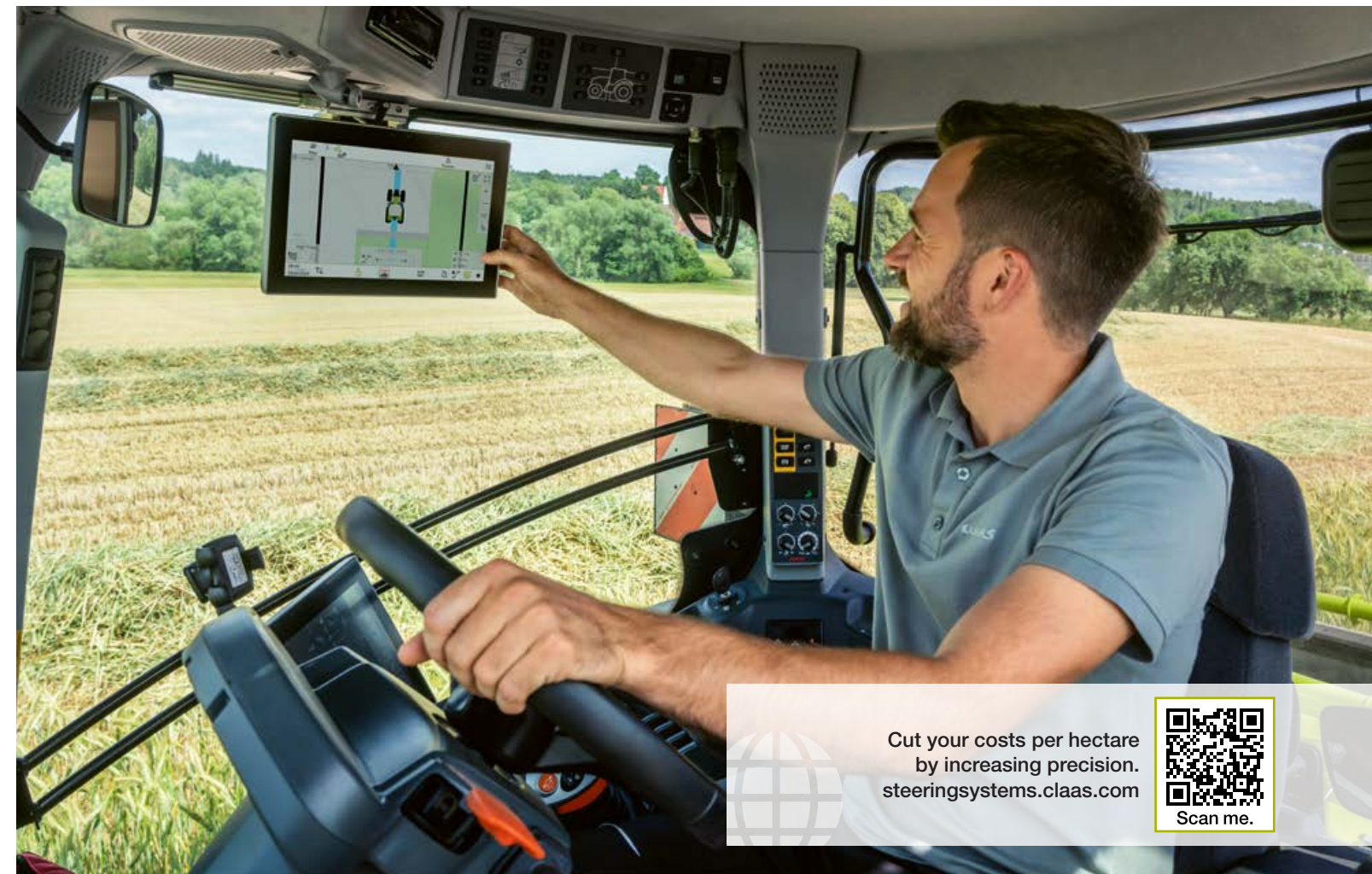

Cut your costs per hectare
by increasing precision.
steeringsystems.claas.com



Scan me.



Reference track management



Tramline management

Precision guidance.

You need a good correction signal for precise work. It's a given with SATCOR 15¹ as standard for 5 years.

Need even greater accuracy?

Choose the optional SATCOR 3¹ and SATCOR 3 FAST¹ correction signals (± 3 cm).

Absolute precision your top priority?

Choose the GPS PILOT CEMIS 1200 with RTK correction signal for the highest possible repeatable accuracy ($\pm 2-3$ cm).

RTK Bridging.

All RTK correction signals are enhanced by the RTK Bridging function as standard, so if the signal is lost, work can continue for up to 20 minutes with gradually decreasing accuracy.

Difficult topography or mobile phone dead zones in your area?

With RTK Bridging Premium you can carry on working – without loss of accuracy or time limits.

¹ SATCOR 15 / SATCOR 3 / SATCOR 3 FAST powered by Trimble RTX. SATCOR correction signals, RTK Bridging and RTK Bridging Premium are not available in all regions. Together with your CLAAS distributor, we will find the best solution for your individual requirements.

GPS PILOT CEMIS 1200. Moving with the times.

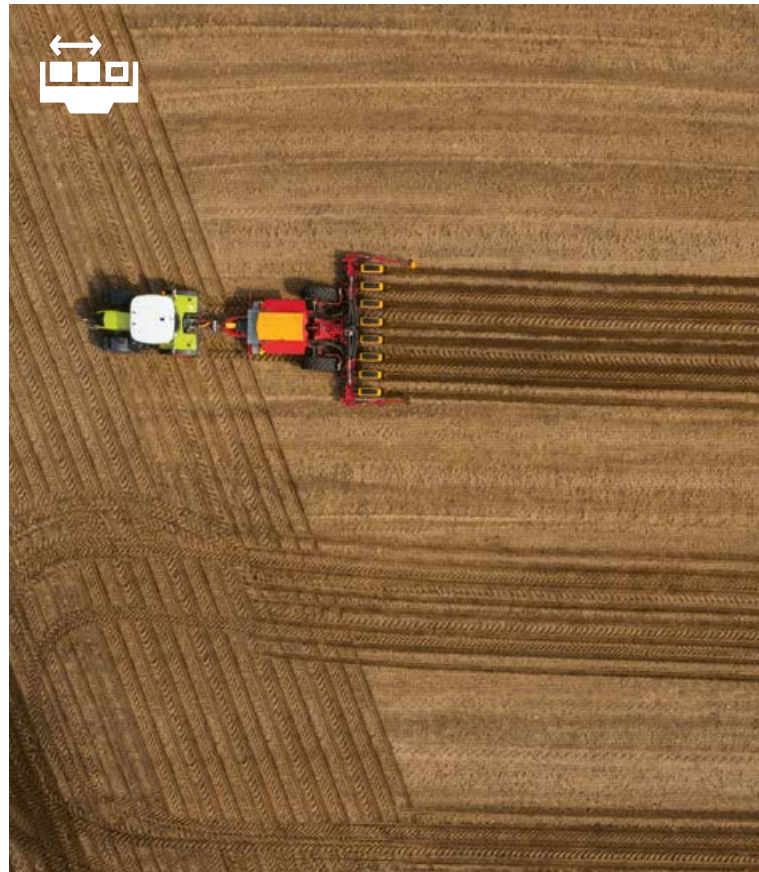

 **Future-proof – GPS PILOT CEMIS 1200.**

With GPS PILOT CEMIS 1200, you get a terminal fit for the future. Tailor-made for your farm, with full functionality pre-installed or added gradually to suit your growing needs.

Still not sure? Why not test additional functions and correction signals free of charge in advance?

Perhaps your requirements have changed during the season? No problem – with the digital connection you can adapt the system's functions quickly and flexibly to suit your needs. The appropriate licence or activation can be transferred online straight to your terminal.¹

 **ISOBUS Universal Terminal (ISO UT).**

The ISO UT implement view can be displayed in the main work screen or in the smaller implement screen. This enables you to customise the display settings to suit your needs. The AUX-N allows functions to be assigned to physical function keys, for example on the CLAAS multifunction control lever.

Benefits:

- Customisable display settings for ISOBUS implements in the CEMIS 1200 terminal
- User-friendly operation using function keys
- Transfer new licences online or activate directly on the terminal

 **ISOBUS TC Section Control.**

The ISOBUS functionality of the CEMIS 1200 allows you to switch sections on or off automatically – for all the precision and none of the hassle.

 **Precision farming and documentation with ISOBUS TC-GEO and VRA.**

With ISOBUS TC-GEO you can easily record geo-referenced data such as application rates. If you want to target applications to specific areas, simply add the VRA (Variable Rate Application) module.

 **Office and machine seamlessly connected. Task management.**

With the CEMIS 1200 and Machine connect, you can handle your job management via your mobile phone connection in just a few clicks – it's standardised and convenient.

Plan your tasks in your farm management software and transfer them straight from CLAAS connect or other connected systems to the machine. The operator has all the tasks in sight and can quickly and easily send them back to the office on completion.

Assign, complete and document – seamlessly and reliably.

¹ in countries with CLAAS connect

A connected tractor is more productive.

Digitalisation pays.

Digitalisation is a key factor in increasing your productivity and efficiency. Data generated in completely different places can be collected and evaluated centrally. This conserves your resources and improves your business processes.

To enable you to get more out of the AXION and your other machines, CLAAS offers a range of modules which allow systems, technology and working processes to be connected with each other, regardless of the manufacturer. Intelligent digitalisation matched to the requirements of your farm can reduce your workload significantly.

- Transfer and document machine and job data quickly
- Manage individual machines and the whole fleet efficiently
- Analyse working processes in detail and optimise them.
- Analyse fields with ease and prepare simple application maps
- Create and manage field track intelligently
- Call up and manage farm data with intelligent farm management software
- Save valuable maintenance and service time with remote diagnostics

NEW: CLAAS connect.

Everything we do revolves around your success, your machines and your farm. And everything you need is now on one platform – CLAAS connect.

With CLAAS connect, all your farm and machine data are clearly arranged in one place. Compare the performance of your machines on the spot to make the most of your fleet's potential. Manage individual service agreements, maintenance notifications, parts catalogues and operating manuals for all your machines. Order parts and consumables straight from your dealer through the integrated shops.

With tramline planning, you can easily create tramlines for efficient fieldwork and manage them on the platform.

Instantly create application maps based on satellite maps for precise, targeted application of seed and fertiliser. Send your jobs complete with tramlines and application maps straight from CLAAS connect to the CEMIS 1200 terminal to ensure simple, precise execution on the field.

Discover how documentation runs in the background, recording your fieldwork reliably and automatically. Focus on your work and let CLAAS connect take care of the rest.

Need another machine in addition to your AXION? No problem! You can configure one at any time in CLAAS connect and ask your dealer to arrange a demonstration or prepare an offer.



CLAAS connect links you to your dealer, your machine and your farm.

connect.claas.com

Scan me.



Digitalisation puts your farm ahead.

- With Machine connect, you can transfer data straight from your machine to CLAAS connect
- With DataConnect, you can keep track of your multi-manufacturer fleet
- With CEMIS 1200, you can create and manage all jobs directly from the machine
- With Remote Service, you can manage maintenance and service operations with ease

Fast,
straightforward maintenance.



Good access saves time and money.

Daily maintenance work should be as straightforward as possible – because we know from experience that nobody enjoys doing things that are complicated or inconvenient.

- The large, one-piece bonnet opens at the press of a button, providing access to all the engine maintenance points
- The engine oil can be checked and topped up on the right-hand side of the tractor when the bonnet is closed
- All daily maintenance tasks can be carried out without tools
- The fuel prefilter is conveniently located by the left-hand cab access ladder
- Large drawer in the left-hand access ladder with space for a standard toolbox
- External battery terminals, e.g. for mobile refuelling in the field

Together, these features speed up daily maintenance tasks. This means that less working time is lost and the tractor is where it should be – at work.

Fresh air for full power.

The large intake panels in the bonnet provide plenty of fresh air for cooling and for the engine air filter. Low flow rates at the intake panels keep them clean and permeable at all times.

The radiator assemblies are supported by a robust frame and have gas-filled shock absorbers that open the radiator panels to two positions for thorough cleaning. So cleaning can be carried out safely and conveniently as and when it is needed.



The air filter is accessibly located in the cool zone in front of the radiator panels so it can easily be removed. Coarse dirt particles are extracted in the filter housing, further extending the cleaning interval.

Whatever it takes. CLAAS Service & Parts.



CLAAS Service & Parts
is there for you 24/7.
service.claas.com

Scan me.



Safeguard your machine's reliability.

Increase your operating reliability and minimise the risk of breakdown and repair. Machine connect offers you predictable costs. Create your own individual service package to meet your particular requirements.

The availability of products from CLAAS Service & Parts may vary according to country.



Specially matched to your machine.

Precision-manufactured parts, high-quality consumables and useful accessories. Choose our comprehensive product range to be certain of receiving exactly the right solution to ensure 100% operating reliability for your machine.



Global supply.

The CLAAS Parts Logistics Center in Hamm, Germany, stocks almost 200,000 different parts and has a warehouse area of over 183,000 m². This central spare parts warehouse delivers all ORIGINAL parts quickly and reliably all over the world. This means that your local CLAAS partner can supply the right solution for your harvest or your business within a very short time.



Your local CLAAS distributor.

Wherever you are, you can count on us to always provide you with the service and the contact people you need. Your CLAAS partners are on hand in your local area, ready to support you and your machine around the clock. With know-how, experience, commitment and the best technical equipment. Whatever it takes.



Machine connect.

Machine connect provides your service partner with all relevant data from machines equipped with telemetry. This makes remote diagnosis and remote support much easier. Servicing can be carried out more efficiently and machine availability is improved. All you have to do is give your consent.

Great features.



CPS.

- Full engine power available at all forward speeds and for all applications
- Low-speed concept: maximum output, maximum torque and maximum top speed at a much lower engine speed reduce operating costs significantly
- Exceptional CMATIC transmission control: dynamic, smooth and fuel-efficient
- Up to 95% of maximum engine output available to the PTO in 1000 ECO mode at 1,600 engine rpm
- Up to 220 l/min hydraulic capacity and eight electronic spool valves

Comfort and convenience.

- Simply everything: CEBIS version with unique 3-finger operation thanks to CMOTION multifunction control lever, 12" CEBIS display with touchscreen, electronic spool valves, CSM headland management, field and implement management
- 4-point cab suspension as standard
- CEMOS operator assistance system
- GPS PILOT CEMIS 1200 with ISOBUS implement control and task management
- ISOBUS implement control via CEBIS

Sales, service and support – our team is here to help.
contact.claas.com

AXION		950	940	930	920
Dimensions and weights					
Standard					
Height: centre of rear axle to cab roof (a)	mm	2425	2425	2425	2425
Length: front linkage folded, cat. IV rear lower links (b)	mm	5744	5744	5744	5744
Wheelbase (c)	mm	3150	3150	3150	3150
Weight	kg	13000-14000	13000-14000	12500-13500	12500-13500



AXION		950	940	930	920
Engine					
Manufacturer		FPT	FPT	FPT	FPT
Number of cylinders		6	6	6	6
Cubic capacity	cm ³	8710	8710	8710	8710
Variable geometry turbo		●	●	●	●
Rated output	kW/hp	273/371	249/338	228/310	205/279
Max. output	kW/hp	311/423	293/398	267/363	242/329
Engine speed at maximum output	rpm	1800	1800	1800	1700
Rated output type approval value (ECE R 120) ^{1, 2}	kW	273	249	228	205
Maximum output type approval value (ECE R 120) ^{1, 2}	kW	311	293	267	242
Max. torque	Nm	1760	1709	1630	1550
Engine speed at max. torque	rpm	1400	1400	1400	1400
Max. fuel tank capacity	l	745	745	745	745
Oil-change interval	h	600	600	600	600

CMATIC continuously variable transmission

REVERSHIFT clutchless reverser		●	●	●	●
Min. speed at rated engine speed	km/h	0.05	0.05	0.05	0.05
Max. speed	km/h	40/50	40/50	40/50	40/50

Rear axle

Max. diameter of rear tyres	m	2.20	2.20	2.20	2.20
Widest rear tyres		750/70 R44	750/70 R44	750/70 R44	750/70 R44
Flanged axle		–	–	●	●
Quick-release axle 2.5 or 3.0 m wide		●	●	○	○
Automatic differential lock		●	●	●	●
Park lock		●	●	●	●
Oil-change interval	h	1200	1200	1200	1200

PTO

External operation of engagement and emergency stop		●	●	●	●
1000	rpm	●	●	●	●
540 ECO / 1000	rpm	○	○	○	○
1000 / 1000 ECO	rpm	○	○	○	○
PTO stub 1 3/8", 6, 8 or 21 splines, and 1 1/4", 6 or 20 splines		□	□	□	□

Four-wheel drive front axle

Rigid front axle		●	●	●	●
PROACTIV front axle suspension		○	○	○	○
Automatic 4-wheel drive		●	●	●	●
Optimum turning radius	m	6.96	6.96	6.96	6.96

Hydraulics

Load-sensing circuit		●	●	●	●
Max. output, standard (option)	l/min	150 (220)	150 (220)	150 (220)	150 (220)
Number of electronic spool valves in CEBIS version		4-8	4-8	4-8	4-8

AXION		950	940	930	920
Rear linkage					
Max. lifting capacity at ball ends	kg	11250	11250	10950	10950
Continuous lift capacity at 610 mm	kg	7690	7690	7520	7520
Cat. III hook		●	●	●	●
Cat. IV hook		○	○	○	○
Vibration damping		●	●	●	●
External controls		●	●	●	●
Active wheel slip control		○	○	○	○

Front linkage

Max. lifting capacity at ball ends	kg	6513	6513	6513	6513
Cat. III hook		●	●	●	●
Vibration damping		●	●	●	●
Position control		○	○	○	○
External controls for front linkage		○	○	○	○
Front PTO		○	○	○	○
Four additional hydraulic connections and one free-flow return line		○	○	○	○
External controls for additional connections		○	○	○	○
ISOBUS and trailer socket		○	○	○	○

Cabs

CEBIS		●	●	●	●
Air conditioning		●	●	●	●
Automatic climate control		○	○	○	○
Passenger seat with integral cool box		●	●	●	●

Data management and operator assistance systems

CEMOS		○	○	○	○
CSM headland management		●	●	●	●
ISOBUS and TIM		○	○	○	○
GPS PILOT ready		●	●	●	●
GPS PILOT CEMIS 1200		○	○	○	○
Machine connect – 5 year licence		●	●	●	●

¹ Meets ISO TR 14396

² Performance data fit criteria for admissibility.

We want to make you the best in your field.

In everything we do, the focus is on you, our customers. We understand your daily challenges. Together with you, we develop agricultural technology ensuring you can farm successfully and sustainably today and in the future. Our digital solutions simplify complex processes and make your work so much more convenient.



CLAAS KGaA mbH
Mühlenwinkel 1
33428 Harsewinkel
Deutschland
Tel. +49 5247 12-0
claas.com